



 (11) 3313 5198 | 2950 3569

 (11) 99408 1811

 www.facebook.com/tndeletro



NOV. 2019
2020



www.tndeletro.com.br



TND
E L E T R Ô N I C A



(11) 3313 5198 | 2950 3569



(11) 99408 1811



www.tndelettronica.com.br



www.facebook.com/tndeletro



33.07.011
TERMINAL FASTON FÊMEA
DJ-623-A6,3A



33.07.010
TERMINAL FÊMEA
PRÉ ISOLADO FDD-5,5-250 AMARELO



33.07.009
TERMINAL FÊMEA
PRÉ ISOLADO FDD-2-250 AZUL



38.20.002
VÁLVULA/SELO P/ PANELA
DE PRESSÃO DE ALUMÍNIO



38.20.000
ABRAÇADEIRA ROSCA
SEM FIM 12-16MM



38.20.001
ABRAÇADEIRA ROSCA
SEM FIM 13-19MM

PONTA PARA FERRO DE SOLDA CÔNICA
HIKARI PLUS/POWER

18.10.008 - 30W

18.10.009 - 40W

18.10.009 - 60W

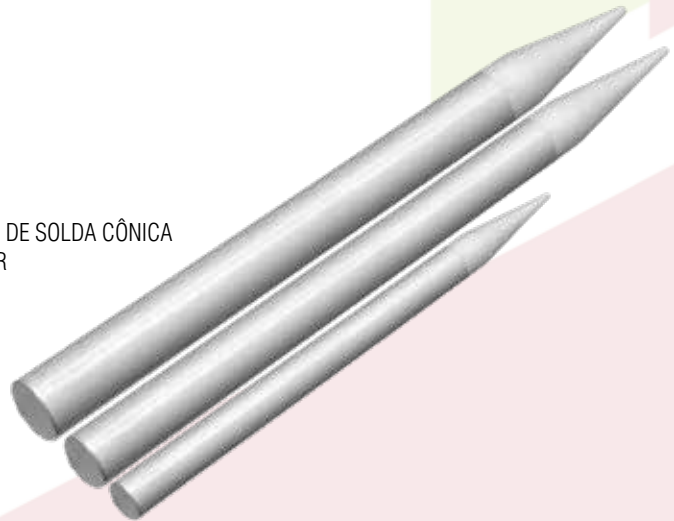

HIKARI



18.06.021
MULTÍMETRO
DIGITAL
HM-1001



18.06.022
ALICATE
AMPERÍMETRO
DIGITAL
HA-266

HIKARI



18.06.020
CAPACÍMETRO
DIGITAL HCP-100

Condições de Venda

- 1) Preço sujeito a reajuste sem prévio aviso.
- 2) Reservamos o direito de alterar, ou não as condições de pagamento.
- 3) O pedido somente será liberado, não havendo títulos em atraso, na ocasião da entrega.
- 4) Frete e risco por conta do destinatário.
- 5) Faturamento mínimo por compra R\$ 500,00 por boleto/parcela.
- 6) Os novos clientes devem enviar junto com o pedido cópia do contrato social, últimas alterações contratuais, cartão do CNPJ e três referências comerciais.

Contatos:

Vendas:

andrea@tndeletronica.com.br
contato@tndeletronica.com.br
eduardo@tndeletronica.com.br
samara@tndeletronica.com.br
joaquim@tndeletronica.com.br
monica@tndeletronica.com.br
neiva@tndeletronica.com.br
cristiane@tndeletronica.com.br

Financeiro:

financeiro@tndeletronica.com.br

Garantia - RMA

rma@tndeletronica.com.br

Endereço:

Rua Henrique Mazzei,
220/240 São Paulo - SP
CEP 02082-050

Política de Troca e Garantia

- Trocas referentes a compra “errada” ou “arrependida”, serão feitas somente após 48 horas do recebimento;
- Componentes eletrônicos, tais como: CI's, transistores, placas c/ circuito, etc... “GARANTIA LIMITADA E SUJEITA À ANALISE”.
- Membranas para forno, teclados para tv's/ máquinas e controle remoto, “6 meses de garantia”, à partir da data da compra.
- Ressalvamos o direito da não troca por uso indevido ou danificação do mesmo no transporte de devolução.
- Nos demais itens do catálogo, favor entrar em contato com nossos vendedores para que possam orientá-los.
- Os teclados de membranas são compatíveis com a marca discriminada. Os números e modelos originais servem apenas como referência para auxílio na identificação do número TND correspondente.
- As imagens utilizadas neste catálogo são meramente ilustrativas.
- Todos os nomes, logotipos de empresas e produtos citados neste catálogo são marcas registradas de suas respectivas corporações.

Todos os nomes, logotipos de empresas e produtos citados neste catálogo são marcas registradas de suas respectivas corporações.

A citação dos mesmos tem a única intenção de auxiliar nossos clientes na identificação de nossos produtos que são compatíveis com os originais.



ABRAÇADEIRA.....	CAPA, 129	CHAVES MICRO SWITCH.....		INTERRUPTOR.....	130	POTENCIÔMETRO.....	135
ACENDEDOR DE CIGARROS.....	73	MICROONDAS.....	25	JACK CANON.....	77	PRATOS P FORNO MICROONDAS.....	22
ACIONADORES MICROONDAS.....	27	CHAVES SMD.....	68	JACK P/ NOTEBOOK.....	147	PROCESSADOR PARA MICROONDAS.....	25
ACOPLADOR MICROONDAS.....	27	CHAVE TESTE VOLTAGEM.....	154	JACKS.....	80, 81	PULSEIRA ANTI-ESTÁTICA.....	152
ADAPTADOR BNC.....	77	CHAVE VGA.....	141	JOYSTICK.....	CAPA	PUXADOR DA PORTA MICROONDAS.....	29
ADAPTADOR BORNE.....	73	CHICOTE PARA SOM AUTOMOTIVO.....	52	KIT CONFECÇÃO PCI.....	72	RABICHO CHICOTE "AUTO".....	53
ADAPTADORES HDMI.....	45	CIRCUITO INTEGRADO.....	164	KIT FERRAMENTAS P/ CELULAR.....	153	REDE RESISTIVA CARBONO.....	160
ADAPTADOR HDMI P/ VGA.....	51	CIRCUITO PARA LAVADORA.....	34	KNOB.....	150	REFLETORES.....	133
ADAPTADOR USB.....	50	CLIP BATERIA.....	44	KNOB MICROONDAS.....	27	RELES.....	149
ADAPTADOR VGA.....	51	CONECTOR.....	73	LÂMPADAS.....	133, 134	RELES MICROONDAS.....	25
ADORNO PARA		CONECTOR BNC.....	82	LÂMPADAS PARA		REPETIDOR WIRELESS.....	140
MÁQUINA DE LAVAR.....	33	CONECTOR BORNE.....	CAPA	FORNO MICROONDAS.....	22	RESISTÊNCIA PARA CHUVERIO.....	125
ÁLCOOL.....	108	CONECTOR DB9.....	74	LED.....	100	RESISTORES.....	157
ÁLCOOL AEROSOL.....	107	CONECTOR DB9.....	74	LIMPA CONTATO DAXXIA.....	107	RESSONADOR.....	149
ALICATES.....	152, 153	CONECTOR F.....	76	LNBF.....	41	RETIFICADOR DIODO.....	100
ALTO FALANTES.....	35	CONECTOR LOUÇA.....	130	LUBRIFICANTE.....		RODÍZIO PARA FORNO MICROONDAS.....	22
AMPERÍMETRO.....	120	CONECTOR USB.....	82	ANTICORROSIVO DAXXIA.....	107	SENSOR EMISSOR DE SINAL.....	85
AMPLIFICADOR PARA		CONECTOR VÍDEO BALLON.....	84	LUBRIFICANTE GRAFITE.....	119	SENSOR LDR.....	149
SOM AMBIENTE.....	139	CONTATO EM OURO TORNEADO.....	70	LUBRIFICANTE GRAXA DAXXIA.....	107	SENSOR RECEPTOR DE SINAL.....	85
AMPOLA.....	61	CONTROLADOR RGB FITA LED.....	104	LUBRIFICANTE SILICONE DAXXIA.....	107	SOLDA.....	122
ANEL O'RING P/		CONTROLE DESLIZANTE		LUBRIFICANTE VASELINA DAXXIA.....	107	SOPRADOR TÉRMICO.....	57
SUGADOR SOLDA.....	122	P/ VENTILADOR DE TETO.....	140	LUMINÁRIA.....	132	SOQUETE PARA CI.....	70
ANTENAS.....	39	CONTROLE R. P/ VENTILADOR.....	141	LUPA.....	155	SOQUETE P/ LÂMPADA.....	22, 129
ARANDELAS PARA		CONTROLES REMOTO.....	86	MAGNETRON MICROONDAS.....	23	SOQUETES.....	149
SOM AMBIENTE.....	35	CONVERSOR HDMI.....	140	MALHA DESOLDADORA.....	119, 123	SPEAKON.....	80
ASSISTENTE PARA SOLDAGEM.....	153	CORREIAS MICRO SYSTEM.....	99	MATERIAL ELÉTRICO FLP.....	127	SPLITTER HDMI.....	140
BALOOON CACHIMBO.....	73	DESENGRAXANTE DAXXIA.....	107	MEMBRANAS PARA BALANÇAS.....	30	SPOT.....	132
BARRA DE TERMINAIS.....	71	DESSOLDADOR DAXXIA.....	108	MEMBRANAS P/ FORNO ELÉTRICO.....	21	SUGADOR DE SOLDA.....	123
BARRA SINDAL.....	125	DIMMER ROTATIVO.....	140	MEMBRANAS P/		SUPORTE (BASE) P/ NOTEBOOK.....	156
BATERIAS.....	42	DIODO.....	100	FORNOS MICROONDAS.....	3	SUPORTE CARRETEL DE SOLDA.....	123
BENJAMIM.....	127, 130	DIODO MICROONDAS.....	26	MICA ISOLANTE.....	151	SUPORTE DE PILHAS.....	44
BICO SILICONE P/		DISJUNTOR AUTOMOTIVO.....	53	MICRO CHOQUE.....	103	SUPORTE DO PCI MICROONDAS.....	28
SUGADOR SOLDA.....	122	DISPENSER PARA ÁLCOOL.....	119	MICROFONE ELETRETO.....	106	SUPORTE FERRO DE SOLDA.....	123
BNC.....	77	DIVISOR DE IMAGEM.....	141	MICRO PINÇA ISOLADA.....	156	SUPORTE MICRO CHAVES	
BORNE.....	73	DIVISOR DE SINAL.....	75	MICROVENTILADOR.....	149	MICROONDAS.....	28
BORNE RCA.....	81	DUMPER.....	100	MINI FURADEIRA.....	152	SUPORTE PARA BATERIA	
BUCHAS TEFLON.....	151	EMENDA HD15 / DB9.....	74	MODULADOR DE RF.....	141	CR2016/2025/2032.....	44
BUZZER.....	45	EMENDA RCA.....	81	MOLA DA PORTA MICROONDAS.....	24	SUPORTE P/ LED.....	101
BUZZER P/ MICROONDAS.....	22	EMENDA RJ 11.....	61	MOLDURA MICROONDAS.....	28	SUPORTE P/ TV.....	148
CABO ADAP. DISPLAY PORT.....	51	EMENDA RJ45.....	61	MOTORES.....	106	TAMPÃO MICROONDAS.....	29
CABO CARREGADOR VEICULAR.....	141	EMENDA T.....	76	MOTORES PARA MICROONDAS.....	24	TAP TIPO T.....	75
CABO COAXIAL.....	55	ENCARTELADOS DAXXIA.....	109	MULTÍMETRO.....	CAPA, 119	TECLA P/ MICROONDAS.....	27
CABO DE FORÇA.....	54	ESCOVA ESD.....	156	ÓCULOS 3D.....	CAPA	TELA DISPLAY LED.....	CAPA
CABO DE FORÇA		ESPAGUETE TERMO RESTRÁTIL.....	56	OLHO DE BOI.....	CAPA	TERMINAIS.....	CAPA
PARA MICROONDAS.....	27	ESPELHOS (ELÉTRICA).....	126	PAINEL MICROONDAS.....	28	TERMISTOR.....	103
CABO DE REDE.....	55	ESPONJA METÁLICA.....	124	PARAFUSO.....	151	TERMOSTATO PARA MICROONDAS.....	24
CABO EXTENSÃO TELEFONE.....	61	ESPONJA VEGETAL.....	123	PASTA P/ SOLDA.....	120	TESTADOR CABO REDE/HDMI.....	152
CABO F.....	55	ESPUMA PROTETORA		PASTA TÉRMICA.....	120	TESTE DE VOLTAGEM.....	152
CABO FIBRA ÓPTICA.....	45	PARA FONE DE OUVIDO.....	156	PERCLORETO.....	121	TINTA ALTA-TEMPERATURA.....	107
CABO FLAT.....	58	ESTILETE.....	152	PERFURADOR DE PLACA.....	124	TINTA P/ FORNO MICROONDAS.....	25
CABO HDMI P/ VGA.....	51	EXTENSÃO ELÉTRICA.....	127, 132	PILHAS.....	44	TOMADA AC.....	130
CABO LAN/CFTV.....	55	EXTENSOR USB RJ45.....	55	PINÇA ANTI-ESTÁTICA.....	155	TOMADA DE SOBREPOR.....	130
CABO P/ FONTE DE NOTEBOOK.....	146	FERRAMENTAS.....	152	PINÇA FLEXÍVEL.....	156	TOMADAS.....	126, 129
CABO P/ FONTE FIO PARALELO.....	142	FERRO DE SOLDA.....	124	PINÇEL ESD.....	156	TRANSFORMADORES	
CABO POE.....	51	FILTRO ADSL.....	61	PISTOLA DE SOLDAR.....	124	PARA MICROONDAS.....	24
CABO RF.....	84	FILTRO DE LINHA.....	132	PLACA ILHADA DE FIBRA.....	71	TRANSISTORES.....	167
CABOS HDMI.....	45	FITA DE LED.....	104	PLACA PROTOBOARD.....	72	TRANSMISSOR E RECEPTOR A/V.....	140
CABOS PARA ÁUDIO E VÍDEO.....	46	FITA ISOLANTE.....	119	PLACAS PARA MICROONDAS.....	25	TRAVA DE PORTA.....	151
CABO TELEFONE.....	61	FIXA FIO.....	55	PLACAS P/ TV'S.....	125	TRENA LASER.....	156
CABO USB.....	49	FLUXO AUTO LIMPANTE.....	119	PLAFON.....	132	TRIMMER.....	151
CABO VGA.....	52	FLUXO NO-CLEAN.....	108	PLUG.....	78	TRIMPOT.....	151
CAIXA ACÚSTICA P/		FLUXO PASTOSO.....	120	PLUG AC.....	127, 131	TRINCOS DA PORTA MICROONDAS.....	28
SOM AMBIENTE.....	139	FONES DE OUVIDO.....	156	PLUG ADAPTADOR.....	148	TWEETER.....	38
CÂMERA DE SEGURANÇA		FONTE CHAVEADA.....	142	PLUG ADAPTADOR MINI DIN.....	76	UNIDADE ÓPTICA.....	58
E ACESSÓRIOS.....	84	FONTE P/ IMPRESSORA.....	145	PLUG BANANA.....	121	VÁLVULA/SELO P/ PAINELA	
CAMISINHA BICO SUGADOR.....	108	FONTE POE.....	51	PLUG CANON.....	77	DE PRESSÃO.....	CAPA
CANETA P/ CIRCUITO IMPRESSO.....	72	FONTES PARA NOTEBOOK.....	144	PLUG CONECTOR MIKE.....	78	VARICAP.....	85
CANON.....	77	FONTE XBOX.....	145	PLUG MODULAR.....	61	VARISTOR.....	100
CAPACITORES.....	160	FUSISTOR.....	102	PLUG P2.....	78	VARISTORES MICROONDAS.....	26
CAPACITORES P/ MICROONDAS.....	26	FUSÍVEIS.....	102	PLUG P4.....	78	VÍDEO BALLOON.....	84
CAPA DB9/HDB15.....	52	FUSÍVEIS MICROONDAS.....	26	PLUG P10.....	79	ZENNER.....	100
CAPA P/ RJ45.....	61	FUSÍVEL LÂMINA.....	103	PLUG RCA.....	79		
CARREGADOR.....	141, 142	FUSÍVEL TÉRMICO.....	103	PLUG RJ 45.....	61		
CASE HDD.....	140	GARRA JACARÉ.....	CAPA, 105	PLUG SPEAKON.....	80		
CHAVEADOR SWITCH HDMI.....	140	GRAFITE EM PÓ.....	119	PONTA DE PROVA.....	121		
CHAVE MICRO SWITCH.....	65	GRAFITE EM PÓ AEROSOL DAXXIA.....	107	PONTA P/ FERRO.....	124		
CHAVES.....	62	GRAXA DE ALTA ADERÊNCIA.....	107	PONTÉ RETIFICADORA.....	100		
CHAVE SELETORA HDMI.....	140	GRAXA SILICONE.....	119	PORTA FUSÍVEL.....	105		

Caro cliente,

Nas páginas seguintes, colocamos à sua disposição, uma enorme gama de modelos de membrana para reposição em fornos micro-ondas, de todas as marcas e modelos do mercado nacional e também algumas de fornos importados.

Mantemos estoque de todos os itens anunciados. Faltas são sistematicamente repostas em no máximo 10 dias. Portanto você não necessita correr o risco de comprar produtos e qualidade inferior.

A QUALIDADE DE NOSSAS MEMBRANAS É INQUESTIONÁVEL.

O índice de devolução das nossas membranas para micro-ondas é infinitamente baixo.

Mesmo sendo muito baixo, o panorama de troca, hoje, indica de cada dez (10) retornos, seis (6) são oriundos de DEFEITOS NAS PLACAS e, não na membrana.

Entendemos que você LOJISTA não tem como testar. Em resultado, aceita a devolução.

Lembramos ao estimado cliente que, a busca por excelência em nossa qualidade, exige que façamos testes em todas as membranas que nos retornam como defeito. É através destas análises que aprimoramos nossa qualidade.

Pedimos que toda membrana devolvida, tenha a informação do defeito descrito. Assim antecipamos processos e confrontamos com o defeito indicado.

TODA E QUALQUER MEMBRANA QUE NÃO APRESENTE DEFEITO SERÁ DEVOLVIDA.

Todos os nomes, logotipos de empresas e produtos citados neste catálogo são marcas registradas de suas respectivas corporações.

A citação dos mesmos tem a única intenção de auxiliar nossos clientes na identificação de nossos produtos que são compatíveis com os originais.



Todos os nomes, logotipos de empresas e produtos citados neste catálogo são marcas registradas de suas respectivas corporações. A citação dos mesmos tem a única intenção de auxiliar nossos clientes na identificação de nossos produtos que são compatíveis com os originais.



21.12.002
BLUE SKY BLU-M 191/192



21.12.003
BLUE SKY BMO 20E-10



21.37.001
BOSCH HMS 20K00AB/HMS 20P00AP

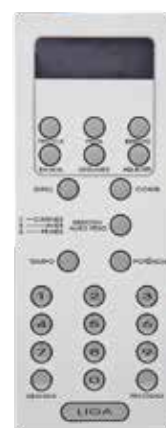

21.37.002
BOSCH HMS 30 GRILL/000074K01, MB 303 BM



21.13.073
BRASTEMP BMA 30 AF



21.13.074
BRASTEMP BMC 20 AF



21.13.001
BRASTEMP BMG 35AB MAXI-GRATINE



21.13.080
BRASTEMP BMJ 38 AR



21.13.047
BRASTEMP BMK 35AE ALL BLACK



21.13.079
BRASTEMP BMP 20



21.13.002
BRASTEMP BMP 23



21.13.003
BRASTEMP BMP 28 EHBAB BRC / MW 5700 BRC



21.13.004
BRASTEMP BMP 28 EHBAB S/DOUR. CN Z/MW 5700 CN Z



21.13.005
BRASTEMP BMP 28 EHC S/DOUR. PRETA



21.13.006
BRASTEMP BMP 28 EJABB CINZA



21.13.007
BRASTEMP BMP 28 EJB C/DOUR. PRETA



21.13.008
BRASTEMP BMP 31 BRC C/DOUR. MEDIDA: 9,7X19,4 CM



21.13.009
BRASTEMP BMP 31 BRC S/DOUR. MEDIDA: 9,7X19,4 CM



21.13.010
BRASTEMP BMP 31 PRT C/DOUR. MEDIDA: 9,7X19,4 CM



21.13.011
BRASTEMP BMP 31 PRT S/DOUR. MEDIDA: 9,7X19,4 CM

Todos os nomes, logotipos de empresas e produtos citados neste catálogo são marcas registradas de suas respectivas corporações. A citação dos mesmos tem a única intenção de auxiliar nossos clientes na identificação de nossos produtos que são compatíveis com os originais.



21.13.012
BRASTEMP BMP 40 AAB BRANCA



21.13.013
BRASTEMP BMP 40 ES CINZA



21.13.014
BRASTEMP BMP 40 ES B PRETA



21.13.015
BRASTEMP BMP 42 BRC C/DOUR.
MEDIDA: 9,7X21 CM



21.13.016
BRASTEMP BMP 42 BRC S/DOUR.
MEDIDA: 9,7X21 CM



21.13.017
BRASTEMP BMP 42 PRT C/DOUR.
MEDIDA: 9,7X21 CM



21.13.018
BRASTEMP BMP 42 PRT S/DOUR.



21.13.019
BRASTEMP BMP 61

INFORMAÇÃO
Brastemp BMS18 AB e tem processador diferente dos demais fornos. Após a função "Cancela" é necessário acionar a "Desliga" cancela, desliga, cancela. Sem esta sequência, trava o processador e dá a impressão de membrana ruim. Requer atenção ao colocar o flat no soquete. Não aceitaremos devolução por este motivo.



21.13.020
BRASTEMP BMS 18 ABHNA



21.13.021
BRASTEMP BMS 25 AB SINGLE
MEDIDA: 27X9 CM



21.13.075
BRASTEMP BMS 26 AB



21.13.022
BRASTEMP BMS 35 AB
MEDIDA: 27,5X9,5 CM



21.13.048
BRASTEMP BMS 45



21.13.081
BRASTEMP BMS 45 CB



21.13.082
BRASTEMP BMS 45 CR



21.13.023
BRASTEMP BMU 27 A C/DOUR.



21.13.024
BRASTEMP BMU 27 A S/DOUR.



21.13.078
BRASTEMP BMW 20



21.13.025
BRASTEMP BMX 35 AB
MEDIDA: 27,5X9,5 CM



21.13.026
BRASTEMP BMX 40 AR KING
SIZE-INOX
MEDIDA: 28X9,2 CM



21.13.072
BRASTEMP BMY 25 SINGLE
INOX
MEDIDA: 27X9 CM



21.40.000
BRITANIA BM18L2



21.40.002
BRITANIA BM21L



21.40.001
BRITANIA BM22PR



21.14.004
CARREFOUR HOME HMO22E-13E



21.14.003
CARREFOUR HOME HMO22E-13



21.15.022
CCE M20T
MEDIDA: 19X17,2X7CM



21.15.004
CCE M34



21.15.005
CCE M304



21.15.006
CCE M308



21.15.007
CCE MW307



21.15.008
CCE MW850

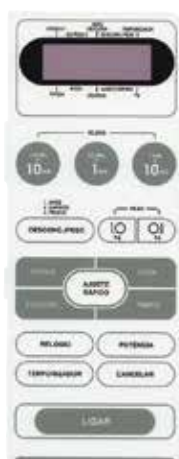

21.15.014
CCE MW1350



21.15.015
CCE MW1400 S/DO UR



21.15.018
CCE MW1550/MW1480



21.15.019
CCE MW1580



21.15.020
CCE MW1600



21.16.021
CONSUL CMA20



21.16.022
CONSUL CMA30



21.16.024
CONSUL CMD20AB



21.16.028
CONSUL CMD20AS CINZA

Todos os nomes, logotipos de empresas e produtos citados neste catálogo são marcas registradas de suas respectivas corporações. A citação dos mesmos tem a única intenção de auxiliar nossos clientes na identificação de nossos produtos que são compatíveis com os originais.



21.16.025
CONSUL CME20AY



21.16.026
CONSUL CME20AZ



21.16.027
CONSUL CMK38AB



21.16.015
CONSUL CMN34AQUARELA



21.16.020 - ESPELHADA
CONSUL CMO20



21.16.016
CONSUL CMP25

INFORMAÇÃO
Consul CMS18 tem processador diferente dos demais fornos. Após a função "Cancela" é necessário acionar a "Desliga" cancela, desliga. Sem esta sequência, trava o processador e dá a impressão de membrana ruim. Requer atenção ao colocar o fiat no soquete. Não aceitaremos devolução por este motivo.



21.16.001
CONSUL CMS18BBHNA/CMS18 CBHNA



21.16.005
CONSUL CMS18 OBHNA



21.16.002
CONSUL CMS25 AB FACILITE/COMPACTO
MEDIDA: 25,5X8,1 CM



21.16.019
CONSUL CMS26



21.16.003
CONSUL CMS30 AB FACILITE/MIDDI
MEDIDA: 26X8,9 CM



21.16.004
CONSUL CMS40 FACI LITE MASTER
MEDIDA: 26,5X8,4 CM

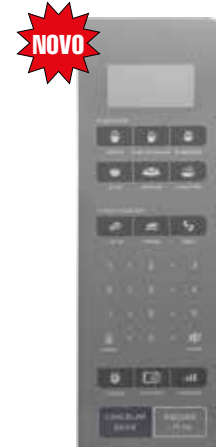

21.16.030 - ESPELHADA
CONSUL CMS45AR



21.16.023
CONSUL CMW20AB



21.16.029
CONSUL CMW30



21.16.014
CONSUL CMY30 FACI LITE/MIDDI
MEDIDA: 26X8,9 CM



21.16.017
CONSUL CMY34AB



21.16.006
CONSUL MU20



21.16.007
CONSUL MU30



21.16.008
CONSUL MU 30/MW 5600



21.16.009
CONSUL MU 31
MEDIDA: 24X8,3 CM



21.16.013
CONSUL MU 42
MEDIDA: 25X8,4 CM



21.17.001
CONTINENTAL AW 30 C/GRILL



21.17.002
CONTINENTAL AW 30 S/GRILL



21.17.004
CONTINENTAL DIGIT 28



21.17.006
CONTINENTAL DIGIT 42



21.17.010
CONTINENTAL MOCT 022SD 2A1BR



21.17.007
CONTINENTAL MW 151 S/DOUR./
P 00156K02, P 00160K01

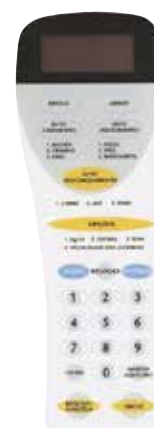

21.17.009
CONTINENTAL P 00158/P 00198K01,
P 00198K02/BOSC H 30L



21.18.001
DAE WOO OF 7892/95BR, KOR 185/
DAYTRON DMO 900G



21.19.002
DAKO MOD K 018SD 2A1BR



21.19.003
DAKO MOD K 018S 2B 2BR



21.39.002
DURABRAND P70B 20AL-TL 1



21.20.031
ELECTROLUX MA 30S



21.20.042
ELECTROLUX MB 37R



21.20.001
ELECTROLUX ME 18 S (RELEVO)



21.20.019
ELECTROLUX ME 18 S
FLAT À ESQUERDA (RELEVO)

INFORMAÇÃO
Em todos os Electrolux que tem a função hora é necessário acionar por 10 segundos a tecla "Hora". Programar o relógio. Testar as funções. Sem este procedimento a membrana não funcionará. Soquetes verdes tem abertura maior que o padrão. Neste caso use fita adesiva como reforço no verso do contato. Não aceitaremos devolução por este motivo.



21.20.002
ELECTROLUX ME 21 G (RELEVO)

Todos os nomes, logotipos de empresas e produtos citados neste catálogo são marcas registradas de suas respectivas corporações. A citação dos mesmos tem a única intenção de auxiliar nossos clientes na identificação de nossos produtos que são compatíveis com os originais.



21.20.003
ELECTROLUX ME21 S (RELEVO)



21.20.004
ELECTROLUX ME28 G (RELEVO)



21.20.005
ELECTROLUX ME28 S (RELEVO)



21.20.006
ELECTROLUX ME28 X (RELEVO)



21.20.007
ELECTROLUX ME30 G BRC (RELEVO)



21.20.008
ELECTROLUX ME30 X PRT (RELEVO)



21.20.009
ELECTROLUX ME45



21.20.013
ELECTROLUX ME46 X / ME47 X



21.20.023
ELECTROLUX MEF28



21.20.030
ELECTROLUX MEF30



21.20.014
ELECTROLUX MEF33 (RELEVO)



21.20.015
ELECTROLUX MEF41 (RELEVO)



21.20.028
ELECTROLUX MEF41 Y



21.20.016
ELECTROLUX MEG33 (RELEVO)



21.20.017
ELECTROLUX MEG41 (RELEVO)



21.20.032
ELECTROLUX MEG41 Y



21.20.039
ELECTROLUX MEO04



21.20.034
ELECTROLUX MEP37
MEDIDA: 20,1X7,4 CM



21.20.029
ELECTROLUX MEP41
MEDIDA: 24,1X7,9 CM



21.20.027
ELECTROLUX MES27



21.20.024
ELECTROLUX MEV 41



21.20.018
ELECTROLUX MEX 41 (RELEVO)



21.20.033
ELECTROLUX MEX 55



21.20.035
ELECTROLUX MG41P
MEDIDA: 24,1X7,9 CM



21.20.025
ELECTROLUX MG 41R



21.20.041
ELECTROLUX MI 41S



21.20.040
ELECTROLUX MI 41T



21.20.038
ELECTROLUX MT 30S



21.20.036
ELECTROLUX MTD 30



21.20.037
ELECTROLUX MTO 30



21.21.001
EMERSON N8665W/8774



21.22.002
ESMALTEC EM 19



21.22.001
ESMALTEC EM 20



21.22.003
ESMALTEC EM 25G



21.39.001
EXCESS EMO23



21.23.001
FIRST LINE CRF 301



21.24.002
GALANZ WP 900AP-25



21.25.001
GE JEI 1145



21.25.002
GE JEI 1185 C/DOUR.



21.25.004
GE MOM 031AS/MG 31ADI-IMPORTADO

Todos os nomes, logotipos de empresas e produtos citados neste catálogo são marcas registradas de suas respectivas corporações. A citação dos mesmos tem a única intenção de auxiliar nossos clientes na identificação de nossos produtos que são compatíveis com os originais.



21.25.005
GE MOGE 031SD 2B IN



21.25.006
GE MOGE P31SD2A



21.14.004
HOME CARREFOUR HMO 20E



21.14.003
HOME CARREFOUR HMO 22E-13



21.38.005
HOME LEADER 17P X 05 / 17PX03



21.38.001
HOME LEADER 20PX60/XB 2320T BRC GRD



21.38.002
HOME LEADER 30PX60 BRC PEQ / 28PX60



21.38.004
HOME LEADER P70B17AP-DF



21.38.006
HOME LEADER P70B20 APSI



21.38.003
HOME LEADER XB2361 PRT GRD



21.26.005
LG GOLDSTAR MB 274 ML C / DOUR



21.26.013
LG MH 3046SP



21.26.015
LG MH 4046SP



21.26.025
**LG MH 4046X
MEDIDA: 17X8,3 CM**



21.26.037 - ESPELHADA
LG MH6346 SS CHEF MENU



21.26.027
**LG MH 7043R / RA, MH 7053R / RA (MFM 63036701) ESPELHADA
MEDIDA: 24,5X8,8 CM**



21.26.041 - ESPELHADA
LG MH 7044L / LA (MFM 63356901)



21.26.024
**LG MH 7047 BRAZILIAN GRILL MFM 62077001
MEDIDA: 15X8 CM**



21.26.018
**LG MH 7047G MIELOU LIG HT
MEDIDA: 16,7X8 CM**



21.26.020
**LG MH 7048 AP MFM 62056701
MEDIDA: 24X9,4 CM**



21.26.032
**LG MH 7048G / 7058G ESPELHADA
MEDIDA: 18X7,8 CM**



21.26.019
LG MH 7049C BRAZILIAN GRILL
 COOK
MEDIDA: 21,5X8,4 CM



21.26.031
LG MH 7049C (MFM 62017001)
 MENU AUTOCOZIMENTO



21.26.039 - ESPELHADA
LG MH 7057Q (MFM 63758101)
 GRILL
MEDIDA: 22X9,3 CM



21.26.026
LG MH 8048AP ESPELHADO
MEDIDA: 27,5X9,3 CM



21.26.007
LG GOLDSTAR MS 74ML/ MS
 116 ML



21.26.016
LG GOLDSTAR MS 1944 ABRC



21.26.017
LG MS 1944JL



21.26.014
LG MS 2346 S
MEDIDA: 19,5X19X8,4 CM



21.26.042
LG MS 2346S/G (MFM62456801)



21.26.035
LG MS 2347 G / GA
MEDIDA: 19,8X8,4 CM



21.26.036
LG MS 2355R
MEDIDA: 24,5X8,8 CM



21.26.030
LG MS 3042R/3042B/3052R/RA
MEDIDA: 24,6X8,9 CM



21.26.034
LG MS 3044L / AL / MS 3043S
 (MFM63356801)
MEDIDA: 19,8X8,2 CM



21.26.038
LG MS 3045 S/AS
MEDIDA: 19,5X8,2 CM



21.26.029
LG MS 3046 SP - 30L
MEDIDA: 19,8X8,2 CM



21.26.022
LG MS-3047 12 PISTAS MFM
 61841701
MEDIDA: 15,2X8 CM



21.26.023
LG MS 3047G 13 PISTAS
 (MFM62038401)
MEDIDA: 15,2X8 CM



21.26.028
LG MS 3048G/3042M/MS3058G/GA
 (MFM62719401)
MEDIDA: 18X7,8 CM



21.26.033
LG MS 3049 L/LA 3059L/LA
 /3043L/LA
MEDIDA: 19X8,6 CM



21.26.040 - ESPELHADA
LG MS3053R/RA (MFM63656901)



21.36.007
MABE MOMB 018SD 2A 2BR
 /1BR
MEDIDA: 15,6X6,4 CM



21.36.000
MABE MOMB 35GCD
MEDIDA: 21X7,3 CM



21.36.002
MIDEA MM 20 EL
MEDIDA: 17,9X7,4 CM



21.36.016
MIDEA MM20EL1BW C/
 RECORTE



21.36.015
MIDEA MM20EL1VWBC
MEDIDA: 20,5X9,3 CM



21.36.003
MIDEA MM30EL
MEDIDA: 22,1X9,3 CM



21.36.011
MIDEA MM35TB1VW
MEDIDA: 16,6X6,6 CM



21.36.010
MIDEA MM39TB1/MM39TB2
MEDIDA: 19,8X8,6 CM



21.36.013
MIDEA MM40TB1/MM40TB2
MEDIDA: 21,2X8,1 CM



21.36.014
MIDEA MTAE41/MTAE42 ESPEL 25L
MEDIDA: 27,9X9,5 CM



21.36.006
MIDEA MTAE21/22 GRILL ESPEL HADO LIVA 20L
MEDIDA: 22,2X7 CM



21.36.009
MIDEA MTAS21/MTAS22 LIVA
MEDIDA: 22,2X7 CM



21.36.012
MIDEA MTAG31/32 LIVA GRILL ESPELHADO 25L
MEDIDA: 18X6,6 CM



21.36.008
MIDEA MTAG41/MTAG42
MEDIDA: 21,4X6,9 CM



21.36.005
MIDEA MTAS41/MTAS42
MEDIDA: 21,4X6,9 CM



21.28.001
PANASONIC NN5550, NN5557, NN5558



21.28.003
PANASONIC NN4557, 5557



21.28.002
PANASONIC NN4558BH



21.28.004
PANASONIC NN5555



21.28.005
PANASONIC NN5556TB



21.28.006
PANASONIC NN5557BK/NN4557



21.28.007
PANASONIC NN5658BJR.PLUS



21.28.077
PANASONIC NN5658BLACK



21.28.008
PANASONIC NN6556BRC/NN6956



21.28.009
PANASONIC NN6557BH



21.28.014
PANASONIC NN6957, NN6556

Todos os nomes, logotipos de empresas e produtos citados neste catálogo são marcas registradas de suas respectivas corporações. A citação dos mesmos tem a única intenção de auxiliar nossos clientes na identificação de nossos produtos que são compatíveis com os originais.



21.28.011
PANASONIC NN 6658, NN 5658, NN 6958



21.28.012
PANASONIC NN 6956 BH



21.28.010
PANASONIC NN 6958 FAMILY PLUS S



21.28.017
PANASONIC NN 7809 BRC / NN 7589



21.28.015
PANASONIC NN 7777 / 000093



21.28.016
PANASONIC NN 7806



21.28.018
PANASONIC NN 7809 PRT



21.28.019
PANASONIC NN 7852 BH



21.28.021
PANASONIC NN 7858



21.28.025
PANASONIC NN 7956B BRC CURVA



21.28.020
PANASONIC NN 7956 PRT CURVA



21.28.022
PANASONIC NN 7956 BRC RETA



21.28.023
PANASONIC NN 7956 PRT RETA



21.28.026
PANASONIC NN 7958 PRT / NN-G79



21.28.028
PANASONIC NNG 43 (RELEVO)



21.28.030
PANASONIC NNG 51 BH



21.28.031
PANASONIC NNG 51 BH (RELEVO)



21.28.032
PANASONIC NNG 52 (RELEVO)



21.28.033
PANASONIC NNG 54 BH (RELEVO)



21.28.034
PANASONIC NNG 55 BH (RELEVO)



21.28.036
PANASONIC NNG 60 BH (RELEVO)



21.28.038
PANASONIC NNG 61 BH (RELEVO)



21.28.040
PANASONIC NNG 62 BH (RELEVO)



21.28.041
PANASONIC NNG 69 (RELEVO)



21.28.042
PANASONIC NNG 70 (RELEVO)

Todos os nomes, logotipos de empresas e produtos citados neste catálogo são marcas registradas de suas respectivas corporações. A citação dos mesmos tem a única intenção de auxiliar nossos clientes na identificação de nossos produtos que são compatíveis com os originais.



21.28.043
PANASONIC NNG 79BH



21.28.072
PANASONIC NNGD 579



21.28.044
PANASONIC NNGD 587



21.28.078
PANASONIC NNGF 580 MRU



21.28.073
PANASONIC NNGF 589



21.28.064
PANASONIC NNGT 517
(RELEVO)



21.28.079
PANASONIC NNGT 672
MEDIDA: 28X10 CM



21.28.089 - ESPELHADA
PANASONIC NNGT 682 SRU



21.28.088 - ESPELHADA
PANASONIC NNGT 684S



21.28.045
PANASONIC NNR 94BH
(RELEVO)



21.28.046
PANASONIC NNR 94BH BRC
(RELEVO)



21.28.047
PANASONIC NNR 95BH BRC
(RELEVO)



21.28.086
PANASONIC NNR 95CNZ
(RELEVO)



21.28.048
PANASONIC NNS 42 **(RELEVO)**



21.28.049
PANASONIC NNS 45 **(RELEVO)**



21.28.029
PANASONIC NNS 46



21.28.050
PANASONIC NNS 49 **(RELEVO)**



21.28.052
PANASONIC NNS 50BH
(RELEVO)



21.28.053
PANASONIC NNS 52 **(RELEVO)**



21.28.054
PANASONIC NNS 53



21.28.055
PANASONIC NNS 55



21.28.056
PANASONIC NNS 56 **(RELEVO)**



21.28.057
PANASONIC NNS 59 **(RELEVO)**



21.28.059
PANASONIC NNS 60BH
(RELEVO)



21.28.060
PANASONIC NNS62 (RELEVO)



21.28.061
PANASONIC NNS65 (RELEVO)



21.28.062
PANASONIC NNS66 (RELEVO)



21.28.063
PANASONIC NNS69 (RELEVO)



21.28.076
PANASONIC NN SF560



21.28.093
PANASONIC NN ST35HWRU



21.28.090
PANASONIC NN ST250W



21.28.080
PANASONIC NN ST252W



21.28.084
PANASONIC NN ST254W



21.28.074
PANASONIC NN ST341



21.28.083
PANASONIC NN ST352W/
362M
MEDIDA: 24,2X9,6 CM



21.28.087
PANASONIC NN ST354W/NN
ST364W/NN ST375M



21.28.065
PANASONIC NN ST357



21.28.071
PANASONIC NN ST358



21.28.070
PANASONIC NN ST359



21.28.067
PANASONIC NN ST369



21.28.066
PANASONIC NN ST558
(RELEVO)



21.28.068
PANASONIC NN ST568



21.28.075
PANASONIC NN ST571



21.28.081
PANASONIC NN ST652W
MEDIDA: 28X10 CM



21.28.085
PANASONIC NN ST654W



21.28.069
PANASONIC NN ST669



21.28.094 - ESPELHADA
PANASONIC NN ST674SRU



21.29.029
PHILCO PME22 ESPELHADO

Todos os nomes, logotipos de empresas e produtos citados neste catálogo são marcas registradas de suas respectivas corporações. A citação dos mesmos tem a única intenção de auxiliar nossos clientes na identificação de nossos produtos que são compatíveis com os originais.



21.29.030
PHILCO PME 22 BR ESPELHADO



21.29.035
PHILCO PME 23 ESPELHADO
MEDIDA: 17,8X6,6 CM



21.29.018
PHILCO PME 25 / PME 25BM



21.29.040 - ESPELHADA
PHILCO PME 25V



21.29.027
PHILCO PME 28



21.29.021
PHILCO PME 31



21.29.025 - ESPELHADA
PHILCO PME 32 / PM 531
MEDIDA: 21,4X7,9 CM



21.29.022
PHILCO PMEG 34



21.29.016
PHILCO PMEG 35



21.29.036
PHILCO PMO 21B



21.29.037 - ESPELHADA
PHILCO PMO 21E



21.29.038
PHILCO PMO 21P - PMO 21T



21.29.039
PHILCO PMO 211



21.29.042
PHILCO PMO 25B BC



21.29.013
PHILCO PMS 18N



21.29.009
PHILCO PMS 18N2



21.29.006
PHILCO PMS 20



21.29.032
PHILCO PMS 22



21.29.010
PHILCO PMS 22N2



21.29.023
PHILCO PMS 22N3 / PMS 18N3 / PMS 27
MEDIDA: 17,8X6,6 CM



21.29.017
PHILCO PMS 23



21.29.020
PHILCO PMS 24 / PMS 18
MEDIDA: 18,5X5,5 CM



21.29.008
PHILCO PMS 25



21.29.015
PHILCO PMS 25N2



21.29.019
PHILCO PMS25N3
MEDIDA: 20,3X8,6 CM



21.29.028
PHILCO PMS26



21.29.041
PHILCO PMS31 INOX- PRETA



21.29.024
PHILCO PMS32
MEDIDA: 21X7,5 CM



21.29.043
PHILCO PMS32P



21.29.007
PHILCO PMS35



21.29.011
PHILCO PMS35N



21.29.012
PHILCO PMS38NP



21.29.014
PHILCO PMS40



21.29.033
PHILCO PMS42



21.29.001
PHILCO PMW50
MEDIDA: 18,5X8 CM



21.29.002
PHILCO PMW110/111
MEDIDA: 21X7,9 CM



21.29.003
PHILCO PMW100/101
MEDIDA: 21X7,8 CM



21.29.004
PHILCO PMW1500



21.29.005
PHILCO PMX35



21.14.001
PREMIUM PM905D-120AZ UL



21.30.001
PROSDÓCIMO TB700 BRC
MEDIDA: 18,5X7,5 CM



21.30.002
PROSDÓCIMO TB800 BRC
MEDIDA: 20,5X7,5 CM



21.30.003
PROSDÓCIMO TB3700 BRC



21.31.001
SAMSUNG MG945W



21.31.004
SAMSUNG MW3250



21.31.005
SAMSUNG MW3560W



21.31.008
SAMSUNG MW4552/4553G

Todos os nomes, logotipos de empresas e produtos citados neste catálogo são marcas registradas de suas respectivas corporações. A citação dos mesmos tem a única intenção de auxiliar nossos clientes na identificação de nossos produtos que são compatíveis com os originais.



21.31.010
SAMSUNG MW 4700



21.16.008
SAMSUNG MW5600/MU30ACWPRT



21.31.016
SAMSUNG MW5620, MW5720
MEDIDA: 10X17,8 CM



21.13.003
SAMSUNG MW5700BRC/BMP28 EHB AB



21.13.004
SAMSUNG MW5700CNZ/BMP28 EHB AB CNZ



21.31.021
SAMSUNG MW5711
MEDIDA: 17,5X9,3 CM



21.31.022
SAMSUNG MW5720/5920 BRC



21.31.023
SAMSUNG MW5720/5920 PRT



21.31.026
SAMSUNG MW6554/6564/5470



21.31.028
SAMSUNG MW6700S/DOUR./W6750
MEDIDA: 9,4X17,5 CM

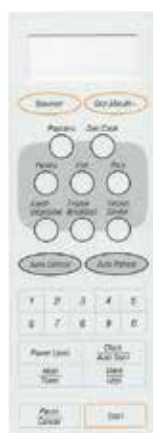

21.31.030
SAMSUNG MW6752
MEDIDA: 8,3X24 CM



21.31.002
SAMSUNG MB6774W/MW7920



21.31.031
SAMSUNG MW6900/6950 C/DOUR.
MEDIDA: 9,4X17,5 CM



21.31.033
SAMSUNG MW6920/6544/6545/7544 C/DOUR.
MEDIDA: 17,4X9,3 CM



21.31.034
SAMSUNG MW8145G



21.31.037
SAMSUNG MW8630/8730 CNZ



21.31.039
SAMSUNG MW8700/8750 S/DOUR.
MEDIDA: 9,4X19 CM



21.31.038
SAMSUNG MW8900/8950 C/DOUR.
MEDIDA: 9,4X19 CM



21.31.041
SAMSUNG MW8920/8554



21.32.001
SANYO EM604



21.32.002
SANYO EM 700 TB PRT
MEDIDA: 18,4X7,5 CM



21.32.004
SANYO EM 704 TGR
MEDIDA: 18,4X7,5 CM



21.32.005
SANYO EM 800 TB PRT
MEDIDA: 20,5X7,5 CM



21.32.006
SANYO EM 801 TB
MEDIDA: 20,7X7,6 CM



21.32.008
SANYO EM 804/EMU 829



21.32.007
SANYO EM 804 TGR
MEDIDA: 20,7X7,5 CM



21.32.010
SANYO EM 829/804



21.32.011
SANYO/ELECTROLUX EM 850, EMF 541



21.32.013
SANYO EM 904 TGR
MEDIDA: 24,8X8,5 CM



21.32.014
SANYO EM 3500



21.32.015
SANYO EM 3700 MARROM



21.32.016
SANYO EM 3700 PRT FOSCO



21.30.004
SANYO EM 3700/TB 3701 PRT BRI LH.



21.32.018
SANYO EMN 370 WB
MEDIDA: 19,5X8,3 CM



21.32.019
SANYO EMN 570 WB
MEDIDA: 22X8,3 CM



21.32.017
SANYO EMW 331 WB
MEDIDA: 19,3X7,6 CM



21.32.020
SANYO EMW 531 WB
MEDIDA: 22,2X7,6 CM



21.33.001
SHARP MW 515 ADORNO



21.33.002
SHARP MW 520 PRT



21.33.003
SHARP MW 530 BRC



21.33.004
SHARP MW 615/620

Todos os nomes, logotipos de empresas e produtos citados neste catálogo são marcas registradas de suas respectivas corporações. A citação dos mesmos tem a única intenção de auxiliar nossos clientes na identificação de nossos produtos que são compatíveis com os originais.



21.33.006
SHARP RB3S16



21.33.007
SHARP RB4A33/RB4A23



21.33.017
SHARP RB5A43/RB4A43/RB5A53



21.33.018
SHARP RB4A56/RB5A56



21.33.008
SHARP RB4A56/RB5A66/RB4A56/RB5A56/RB5A66



21.33.013
SHARP RB4B58



21.33.009
SHARP RB4B14(19,7CM)GD



21.33.010
SHARP RB4B26B



21.33.012
SHARP RB4B28C/D/OUR



21.33.016
SHARP RB4B82



21.33.014
SHARP RB4B97



21.33.015
SHARP RB4H46/RB5H66



21.33.019
SHARP RB6K43



21.34.001
WALITTA MW01 S/D/OUR



21.34.002
WALITTA MW03

Membranas para Forno Elétrico



21.13.083
BRASTEMP BOG 40 AR PRATA



21.13.076
BRASTEMP BOG 40 ABANA



21.29.034
PHILCO ROTISSERIE 32L
MEDIDA: 17,7X7,5 CM



21.29.031
PHILCO 42E ELÉTRICO
MEDIDA: 18,6X7,2 CM



21.29.026
PHILCO 42E ELÉTRICO
MEDIDA: 26,3X7,8 CM



21.06.003
PRATO LISO 24,5 CM, LG 24I. / LG MS 74, MS 274 /
BLUESKY BLU-M 191



21.06.004
PRATO ENCAIXE TREVO 24,5 CM
CCE M17 / DAKO MODK 018SD2A1BR
/ MD17 AMB / ELECTROLUX ME 18, ESMALTEC ME 20
/ PANASONIC NNS42, NNG43, NNS45, NNST357, 358,
PHILCO PMS 20



21.06.005
PRATO ENCAIXE TREVO 27 CM BRASTEMP BMS 18
/ BMS 25, CCE M 200, CONSUL CMS 18BB, CMS 25,
ELECTROLUX ME 21, MEF 28, HOME LEADER XB 2320,
PANASONIC NN-S49, NN 4558 PHILCO PMS 25, 25N2,
MIDEA MM25



21.06.010
PRATO ENCAIXE TREVO 27 CM
ELETROLUX MEF 33 E OUTROS



21.06.007
PRATO ENCAIXE TREVO 31,5 CM BRASTEMP BMS 35 / BMX35 / ELECTROLUX ME
28 / MEF 41/ PANASONIC TODA LINHA JUNIOR / ELECTROLUX ME 28S / BOSCH /
BRASTEMP/ CONSUL / HOME LEADER/ PANASONIC

Rodízios / Lâmpadas



32.08.021
RODÍZIO PARA FORNO MICROONDAS CONSUL/
ELETCTROLUX / DIAMETRO 19 CM



32.08.020
RODÍZIO PARA FORNO MICROONDAS PANASONIC
LINHA FAMILY / DIAMETRO 23,5 CM



01.44.008
BUZZER PARA
MICROONDAS



38.11.004
LÂMPADA **125V** 20W
SOQUETE BAQUELITE
P/ MICROONDAS



38.11.015
LÂMPADA **220V** 20W
SOQUETE DE BAQUELITE PARA
MICROONDAS



LÂMPADA 20W
ROSCA FINA PARA MICROONDAS
38.11.002 - 100V
38.11.009 - 220V



38.16.030
SOQUETE DE BAQUELITE ROSCA FINA
PARA MICROONDAS

Todos os nomes, logotipos de empresas e produtos citados neste catálogo são marcas registradas de suas respectivas corporações. A citação dos mesmos tem a única intenção de auxiliar nossos clientes na identificação de nossos produtos que são compatíveis com os originais.



21.03.000
2M 218H - D623



21.03.001
2M 218J - D622

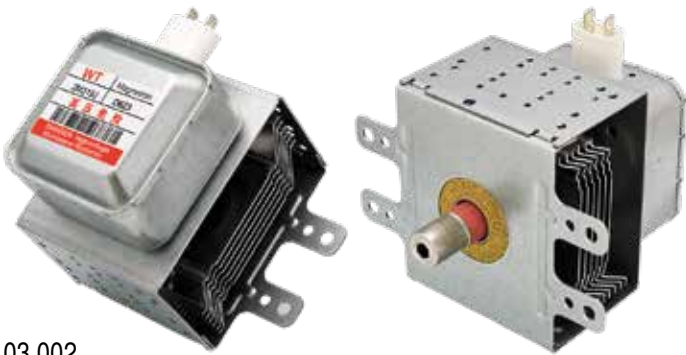

21.03.002
2M 219J = 319J - D623



21.03.003
2M 319K - D625



21.03.007
MAGNETRON 2M 219J/319J SUP 3 FUROS - D622

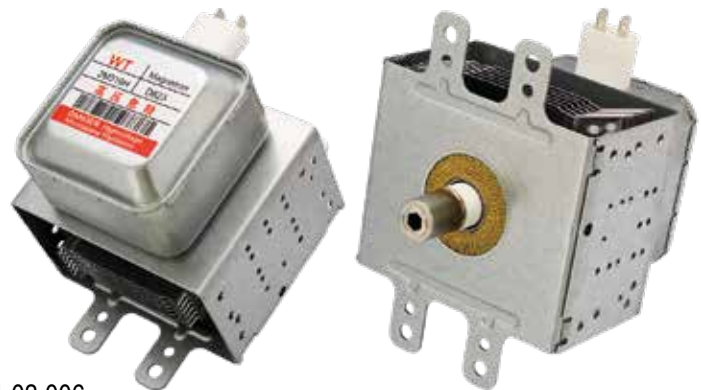

21.03.006
2M 219H (930) 319H - D623



21.03.009
MAGNETRON DAEWOO 2M218



21.03.012
MAGNETRON M24F B-610A - D622

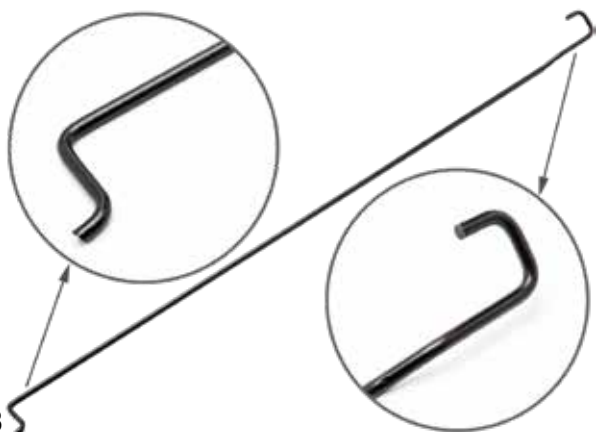

21.13.038
BRASTEMP - MOLA DA PORTA BMU 38 / BMK27



- TERMOSTATO **10 AMP.**
- 15.14.002 - 80°.....
 - 15.14.004 - 100°.....
 - 15.14.012 - 105°.....
 - 15.14.005 - 120°.....
 - 15.14.006 - 130°.....
 - 15.14.003 - 145°.....
 - 15.14.000 - 150°.....
 - 15.14.013 - 180°.....



- TERMOSTATO **10 AMP. CERÂMICO**
- 15.14.007 - 150°
 - 15.14.008 - 160°
 - 15.14.009 - 175°
 - 15.14.010 - 192°



15.14.011
TERMOSTATO 150° **15AMP.**



15.14.014
TERMOSTATO CERÂMICA 192° 15A

Motores para Microondas



MOTOR P/ FORNO M. ONDAS 5/6RPM 4W 50/60HZ
EIXO PLÁSTICO MEIA CANA

- 22.02.001 - 110V
- 22.02.002 - 220V



MOTOR P/ FORNO M. ONDAS 5/6 RPM 4W 50/60HZ
EIXO METÁLICO

- 22.02.004 - 110V
- 22.02.003 - 220V



MOTOR P/ FORNO M. ONDAS 5/6 RPM 4W 50/60HZ
GALANZ

- 22.02.005 - 110V

Transformadores para Microondas



34.33.026 - 110V
TRANSFORMADOR DE
ALTA PARA MICROONDAS



34.33.025 - 220V
TRANSFORMADOR DE
ALTA PARA MICROONDAS



34.33.027
TRANSFORMADOR DE BAIXA 120V

Todos os nomes, logotipos de empresas e produtos citados neste catálogo são marcas registradas de suas respectivas corporações. A citação dos mesmos tem a única intenção de auxiliar nossos clientes na identificação de nossos produtos que são compatíveis com os originais.

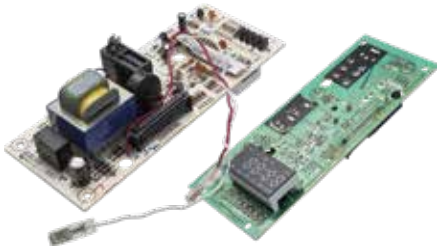

29.07.000
PLACA PARA MICROONDAS PHILCO PMS24 110V



29.07.001
PLACA PARA MICROONDAS PHILCO PMS24 220V

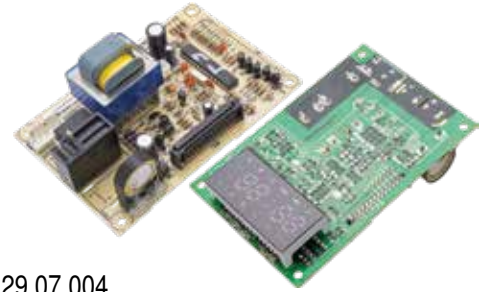

29.07.004
PLACA PARA MICROONDAS CMK38 PNW10634214

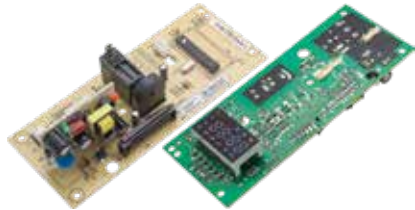

29.07.002
PLACA PARA MICROONDAS CME20 10635088 220V

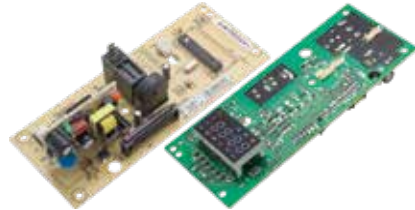

29.07.003
PLACA PARA MICROONDAS CME20 PNW10635087 110V

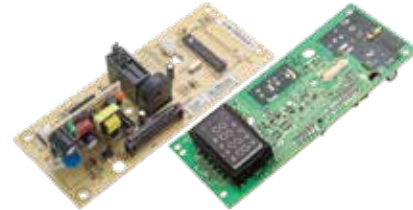

29.07.005
PLACA PARA MICROONDAS CM020 PNW10635084



11.09.022
C.I. HD 404316A915



TINTA DAXXIA 300ML

- 21.08.000 COR BRANCO
- 21.08.001 COR BEGE CLARO
- 21.08.003 COR PRETA



ATÉ 12 PÇS
DE 13 A 36 PÇS
DE 37 A 54 PÇS
DE 55 A 102 PÇS
ACIMA DE 102 PÇS PROGRAMADA

IMPORTANTE :
A TINTA SECA P/ CONTATO EM 2 HORAS, MAS A CURA TOTAL SE DÁ EM 24 HORAS. EVITE DESPERDÍCIO E ABORRECIMENTO. SÓ AUTORIZA O USO DO FORNO RECUPERADO APÓS 30 HORAS DA APLICAÇÃO

Reles / Micro Switch



25.01.015
RELE P/ MICROONDAS 12V ELECTROLUX / BRASTEMP / CONSUL



10.19.003
CHAVE MICRO SWITCH MICROONDAS 15AMP - NA GALANZ



10.19.009
CHAVE MICRO SWITCH MICROONDAS 16AMP

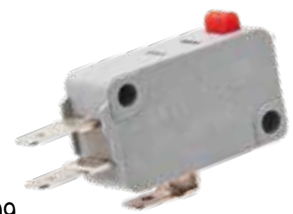

10.19.011
CHAVE MICRO SWITCH 15A 250V PRETA



10.19.013
CHAVE MICRO SWITCH 16A VERDE



10.19.014
CHAVE MICRO SWITCH P/ FRITADEIRA ELÉTRICA





15.00.001
DIODO DE ALTA TENSÃO
12KVA AXIAL ESJC 01-12BX

MÚLTIPLO
5 Pcs

15.00.005
DIODO ALTA TENSÃO DUPLA
HV 6X2PI 3-15 KVA 350MA



MÚLTIPLO
5 Pcs

Fusíveis Microondas

MÚLTIPLO
10 Pcs



19.01.000
FUSÍVEL DE VIDRO RETARDO
0,80 A (6X40MM)

NOVO



PORTA FUSÍVEL
PARA MICROONDAS
19.06.025 - SEM FUSÍVEL
19.06.026 - COM FUSÍVEL



FUSÍVEL CERÂMICO PEQUENO
C-20AGKF C/ AREIA NACIONAL
19.00.018 - 6A
19.00.019 - 8A
19.00.020 - 10A
19.00.021 - 12A
19.00.022 - 15A
19.00.023 - 20A
19.00.024 - 25A



FUSÍVEL CERÂMICO PEQUENO
IMPORTADO 5X20
19.00.030 - 8A
19.00.031 - 10A
19.00.032 - 15A
19.00.033 - 20A



FUSÍVEL CERÂMICO GRANDE
IMPORTADO 6X30
19.00.000 - 8 A
19.00.001 - 10 A
19.00.002 - 12 A
19.00.003 - 15 A
19.00.004 - 20 A
19.00.011 - 25 A



FUSÍVEL CERÂMICO GRANDE
C/ AREIA NACIONAL 6X30
19.00.029 - 10A
19.00.027 - 15A
19.00.028 - 20A
19.00.038 - 25A

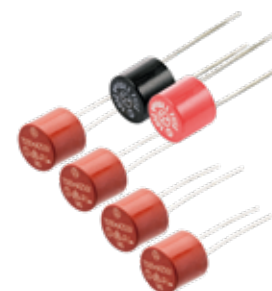

FUSÍVEL DE PICO
19.05.001 - 0,315A

Varistores

MÚLTIPLO
10 Pcs

- 15.06.004 7MM 07D391K 250V.....
- 15.06.009 10MM 10D201K 130V.....
- 15.06.010 10MM 10D241K 150V.....
- 15.06.012 10MM 10D391K 250V.....

- 15.06.017 14MM 14D201K 130V.....
- 15.06.018 14MM 14D241K 150V.....
- 15.06.019 14MM 14D361K 230V.....
- 15.06.020 14MM 14D391K 250V.....

Capacitores



- 2 TERMINAIS FINO**
- 07.00.018 0,70 µF X 2100 VAC 2 T. FINO
 - 07.00.033 0,75 µF X 2000 VAC 2 T. FINO
 - 07.00.019 0,80 µF X 2100 VAC 2 T. FINO
 - 07.00.021 0,85 µF X 2100 VAC 2 T. FINO
 - 07.00.010 0,90 µF X 2100 VAC 2 T. FINO
 - 07.00.020 0,92 µF X 2100 VAC 2 T. FINO
 - 07.00.003 0,95 µF X 2100 VAC 2 T. FINO
 - 07.00.013 1,00 µF X 2100 VAC 2 T. FINO

- 2 TERMINAIS LARGO**
- 07.00.030 0,80 µF X 2100 VAC 2 T. LARGO
 - 07.00.022 0,85 µF X 2100 VAC 2 T. LARGO
 - 07.00.024 0,90 µF X 2100 VAC 2 T. LARGO
 - 07.00.011 0,95 µF X 2100 VAC 2 T. LARGO

- 3 TERMINAIS LARGO**
- 07.00.008 0,85 µF X 2100 VAC 3 T. LARGO
 - 07.00.009 0,90 µF X 2100 VAC 3 T. LARGO
 - 07.00.005 0,95 µF X 2100 VAC 3 T. LARGO
 - 07.00.014 1,00 µF X 2100 VAC 3 T. LARGO

Todos os nomes, logotipos de empresas e produtos citados neste catálogo são marcas registradas de suas respectivas corporações. A citação dos mesmos tem a única intenção de auxiliar nossos clientes na identificação de nossos produtos que são compatíveis com os originais.

05.10.158
10A - 1 MT
BRANCO ORIGINAL



05.10.160
10A - 1,5 MT
BRANCO ORIGINAL



05.10.113
10A - 1 MT
PRETO
ORIGINAL



05.10.109
16A - 1MT
BRANCO



05.10.159
16A - 1,5 MT
BRANCO
ORIGINAL

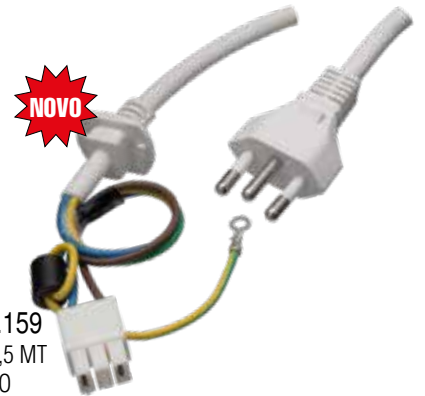

Acoplador

32.19.006
ELECTROLUX E OUTROS 30MM E=17MM



32.19.007
ELETROLUX / BRASTEMP 33MM E=15MM ORIGINAL



32.08.011
PANASONIC NNS 42/45/46 NNST357 ORIGINAL



32.08.013
PANASONIC LONGO
NN 5556/5657/5658
E LINHA JR. ORIGINAL



32.14.036
SHARP MW515/520/615/620



32.14.037
SHARP RB3S 16



Knob / Acionadores

32.02.050 - CCE
M 200



32.18.017
EIXO DO
POTENCIOMETRO
FORNO BRASTEMP
BMC38



32.02.035
CCE MW 300/301 BR

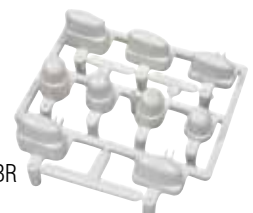

32.14.034
SHARP LINHA RB 3S16



32.14.030
SHARP MW 530/630 BRANCA



32.14.035
SHARP MW 515/520/615/620 PRETA



32.02.033 - CCE
MOLDURA INTERNA DA PORTA
MW 1400/1480/1550/1580
D34/DR-34

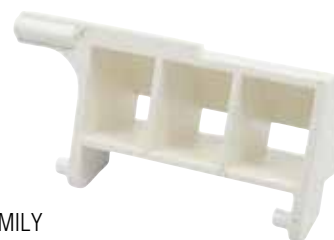

32.08.009
PANASONIC LINHA FAMILY

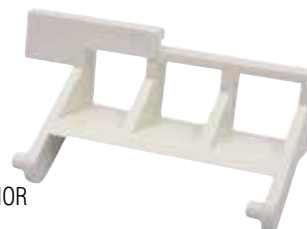

32.08.008
PANASONIC LINHA JUNIOR

Painel Microondas



32.18.009
BRASTEMP BMC 27, BMP 27 /
CONTINENTAL P 00156K01/P 00156K02



32.08.006
PAINEL PLÁSTICO NN 7954, 7956, G79

Suporte PCI / Micro Chaves

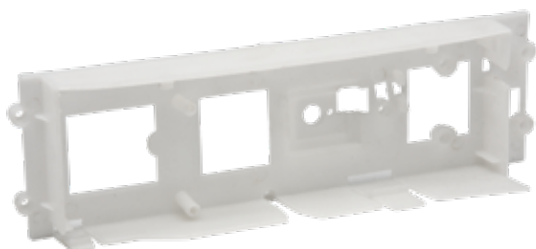

32.18.010 - BRASTEMP
SUPORTE DO PCI BMC 38 / PCI BMK 27 (4919.677.3865.4)

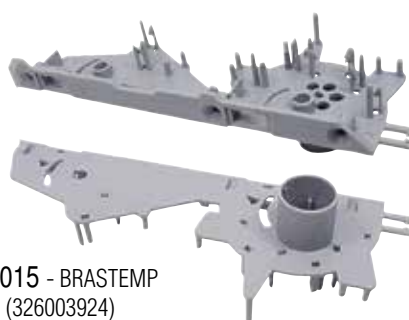

32.18.015 - BRASTEMP
BMP 38 (326003924)



32.08.022
PANASONIC NN5T341

Trincos da Porta Microondas



32.18.007
BRASTEMP BMP 40



32.18.008
BRASTEMP BMC 38 / BMC 27 / BMK 27

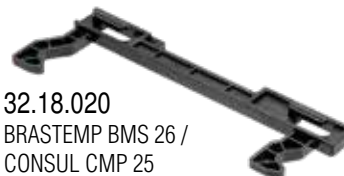

32.18.020
BRASTEMP BMS 26 /
CONSUL CMP 25



32.18.019
BRASTEMP BMS 35,
BMX 35



32.18.021
CONSUL CM020 /
CMD20
PHILCO PME25



32.18.016
CONSUL CMS 18



32.19.000
ELECTROLUX ME 27F



32.08.005
PANASONIC NN ST357/ NN S45



32.08.018
PANASONIC NNST571 - NN556

32.19.004
PUXADOR DA PORTA ELETROLUX
ME 27S



32.19.005
PUXADOR DA PORTA ELECTROLUX
ME 27F



Tampão Microondas

21.02.000
SANYO (46X107MM) EM 604, 700, 704, 800, 804
PHILCO (46X107MM) INJETADO PMW 50/100/101



Guia De Ondas

21.02.018 - DIVERSOS
(200X250MM) USO GERAL



21.02.019 - DIVERSOS
(300X250MM) USO GERAL

APROVEITE!
UTILIZÁVEL EM
DIVERSOS
MODELOS

21.02.017 - PANASONIC
NN 5556
(165X150MM)

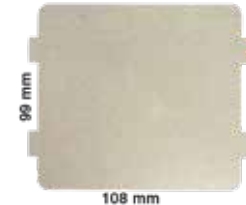

21.02.013 - ELETROLUX*
ME 21, ME 28, MEF28, MEF 41

- 21.02.020 BRASTEMP BMP 27
PQ 25X128MM
- 21.02.021 BRASTEMP BMP 40
- 21.02.010 CCE MW 1300/MW 1350
89X47X96X104MM
- 21.02.024 CCE MW 350 48X122MM
- 21.02.025 CCE MW 750 87X108MM
- 21.02.026 CCE/DAEWOO 88X100MM
- 21.02.074 CONSUL CMY 30/
CMS 30 82X106MM
- 21.02.077 GALANZ WP 900 AP25
- 21.02.050 GOLDSTAR 64X155MM
- 21.02.052 GOLDSTAR 131X133MM
- 21.02.058 GOLDSTAR 50 X 102MM
- 21.02.059 GOLDSTAR 58 X 104MM
- 21.02.028 GOLDSTAR 83, 5 X 113MM
- 21.02.071 GOURMET WAVE
EM 720 CKE, MM720 CKE
- 21.02.078 HOME LEADER X B2320/30PX60/
BLUESKY 30PX60 105X105MM
- 21.02.072 LG MH 4046/7047
122X133MM
- 21.02.029 LG MS 316, MH 685/
BOSCH P 00177K 108X130MM
- 21.02.030 LG MS 74/BLUESKY
BLU-M 191 112X135MM

- 21.02.041 PANASONIC 50X120MM
- 21.02.031 PANASONIC 63X103MM
- 21.02.032 PANASONIC 82X115MM
- 21.02.054 PANASONIC 86X108MM
- 21.02.055 PANASONIC MN 7956BAH
105X115MM
- 21.02.053 PANASONIC NN 6558BH
86X107MM
- 21.02.075 PHILCO PMS 25N2
- 21.02.076 PHILCO PMS18N/18N2/22N2/HOME
LEADER P/ 70817AP -DF
- 21.02.004 PREMIUM PM905D120
69X100MM
- 21.02.037 SAMSUNG 90X120MM
- 21.02.038 SAMSUNG 90X143MM
- 21.02.035 SAMSUNG 78X111MM
- 21.02.036 SAMSUNG MW
5920 83X116MM
- 21.02.034 SAMSUNG MW 8145
45X111MM

- 21.02.068 SANYO 41X107MM
- 21.02.006 SANYO EM 904 70X103MM
- 21.02.040 SANYO EM 904
REDONDA 140MM
- 21.02.069 SANYO 52X114MM
- 21.02.042 SHARP 55X108MM
- 21.02.046 SHARP 98X110MM
- 21.02.014 SHARP 103X110MM
- 21.02.045 SHARP 103X110MM
- 21.02.047 SHARP 100X117MM
- 21.02.061 SHARP 104X116MM
- 21.02.063 SHARP 8R71 105X118MM
- 21.02.064 SHARP 106X121MM
- 21.02.065 SHARP 106X146MM
- 21.02.044 SHARP IMPORTADOS
82X107MM
- 21.02.015 SHARP MW 515 105X112MM
- 21.02.009 SHARP RB 3S16 79X119MM
- 21.02.049 SHARP RB 3A53 103X117MM
- 21.02.011 SHARP RB 4B14 98X107MM

Todos os nomes, logotipos de empresas e produtos citados neste catálogo são marcas registradas de suas respectivas corporações. A citação dos mesmos tem a única intenção de auxiliar nossos clientes na identificação de nossos produtos que são compatíveis com os originais.

MEMBRANAS PARA BALANÇAS

LANÇAMENTO



41.01.012
FILIZOLA IDM LED 16 TECLAS CINZA VISOR VERMELHO



41.01.007
FILIZOLA CS 15 LCD CLASSE III MARROM



41.01.009
FILIZOLA CS 15 LED CINZA

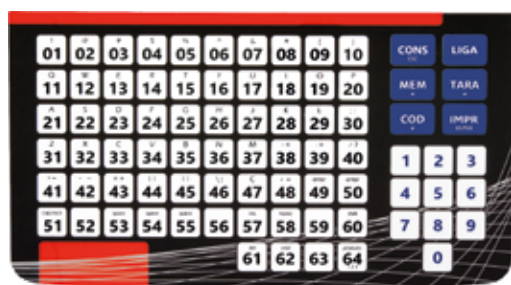

41.01.016
FILIZOLA PLATINA NOVA PRETO E VERM.



41.01.017
FILIZOLA PLATINA UNIFICADA PRETA TECLA VERDE



41.01.018
FILIZOLA PLURIS ANTIGO



41.01.019
FILIZOLA PLURIS NOVA



41.01.000
FILIZOLA BCSA



41.01.001
FILIZOLA BCSI



41.01.002
FILIZOLA BP 15 LCD OPERADOR CINZA



41.01.003
FILIZOLA BP 15 LED CREME



41.01.004
FILIZOLA BP 15 MARROM

Todos os nomes, logotipos de empresas e produtos citados neste catálogo são marcas registradas de suas respectivas corporações. A citação dos mesmos tem a única intenção de auxiliar nossos clientes na identificação de nossos produtos que são compatíveis com os originais.



41.01.005
FILIZOLA CS 15 BATERIA BRANCA
R\$ 5,70



41.01.006
FILIZOLA CS 15 BATERIA CLASSE III

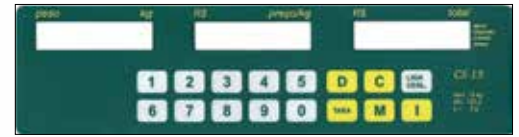

41.01.008
FILIZOLA CS 15 LCD VERDE



41.01.010
FILIZOLA CS 15 LED CLASSE III MARRON
R\$ 5,70



41.01.011
FILIZOLA EA 15 MARRON CLARO
R\$ 16,51



41.01.013
FILIZOLA IDM LCD 16 TECLAS CINZA VISOR TRANSP
R\$ 10,62



41.01.014
FILIZOLA PLATINA CUSTON PRETA CINZA
R\$ 36,65



41.01.015
FILIZOLA PLATINA CUSTON PC PRETO/CINZA
R\$ 47,22



41.02.000
TOLEDO 9091 AZUL



41.02.002
TOLEDO 9094 FLEX AZUL
R\$ 11,99



41.02.005
TOLEDO PRIX 3 CINZA
R\$ 11,48



41.02.006
TOLEDO PRIX 3 CINZA BATERIA



41.02.007
TOLEDO PRIX 3 LC AZUL



41.02.008
TOLEDO PRIX 3 LIGTH AZUL
R\$ 23,75



41.02.010
TOLEDO PRX 4 6
15 KG PRETA
R\$ **42,72**



41.02.011
TOLEDO PRX 4 6 - 15 - 30KG C VISOR AZUL



41.02.012
TOLEDO PRX 4 6 - 15 - 30KG C VISOR TRANSP

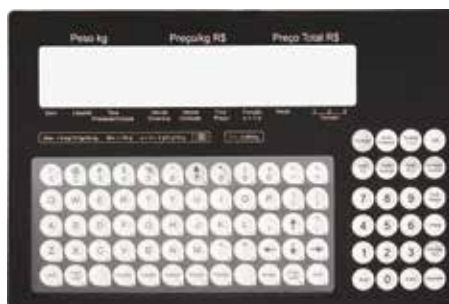

41.02.015
TOLEDO PRX 4 DUE PRETA



41.02.016
TOLEDO PRX 5 6 - 15 KG INTERVAL AZUL



41.02.017
TOLEDO PRX 5 6 - 15 - 30KG AZUL



41.02.018
TOLEDO PRX 5 6 - 15 - 30KG PRETA



41.02.019
TOLEDO PRX 5 6 - 15 - 30KG PLUS PRETA



41.02.020
TOLEDO PRX 6 - 15 - 30KG -PLUS PRETA



41.02.001
TOLEDO 9094 CINZA



41.02.003
TOLEDO 9094 FLEX CINZA



41.02.004
TOLEDO 9094 LIGTH AZUL



41.02.009
TOLEDO PRX 3 NAJA CINZA



41.02.013
TOLEDO PRX 4 CINZA COM ARRUELA DE AT.

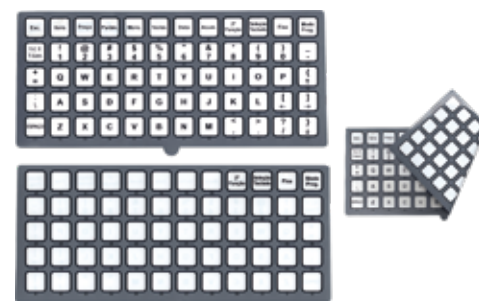

41.02.014
TOLEDO PRX 4 CINZA CARTELA

Todos os nomes, logotipos de empresas e produtos citados neste catálogo são marcas registradas de suas respectivas corporações. A citação dos mesmos tem a única intenção de auxiliar nossos clientes na identificação de nossos produtos que são compatíveis com os originais.



43.04.000 - BRASTEMP
BWB 22A/BWB 22BB 5KG



43.04.003 - BRASTEMP
BWC 10 10KG



43.04.004 - BRASTEMP
BWC 10/B/WC10A 10K



43.04.005 - BRASTEMP
BWC C07A 7KG CLEAN



43.04.006 - BRASTEMP
BWF09A



43.04.008 - BRASTEMP
BWG11AB/11BB/11AR



43.04.009 - BRASTEMP
BWG 11AB FAST TILL 11KG



43.04.011 - BRASTEMP
BWH08B SENSE



43.04.012 - BRASTEMP
BWH09A 9KG



43.04.013 - BRASTEMP
BWH15 15KG



43.04.014 - BRASTEMP
BWK 11A 11KG



43.04.015 - BRASTEMP
BWL11ARB 11KG



43.04.016 - BRASTEMP
BWM 06 6KG



43.04.017 - BRASTEMP
BWM08A TURBO EFICIÊNCIA

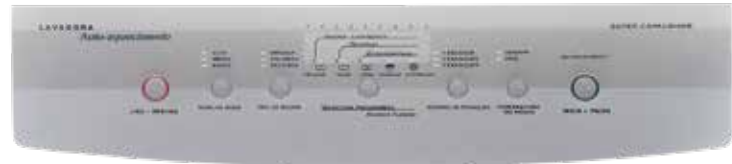

43.04.020 - BRASTEMP
BWQ 24 7KG



43.04.021 - BRASTEMP
BWR2C2 18 PROGRAMAS



43.04.022 - BRASTEMP - BRANCA
43.04.023 - BRASTEMP - CINZA
BWS 15AB 15KG



43.04.024 - BRASTEMP
BWT09B 9KG MEU JEITO



43.04.026 - BRASTEMP
BWX 09A SENSE INOX



43.04.027 - BRASTEMP
BWX09B 6TH 9KG SENSE



43.04.028 - BRASTEMP
BWX09B 6TH 9KG



43.05.001 - CONSUL
CWC 22 5KG



43.05.002 - CONSUL
CWC 24A 7KG



43.05.003 - CONSUL
CWE 06 6KG PRATICE



43.06.000 - ELECTROLUX
TURBO COMPACT 6KG

Lavadora

21.13.027
BRASTEMP
LAVAD. CLEAN
CIRCUITO

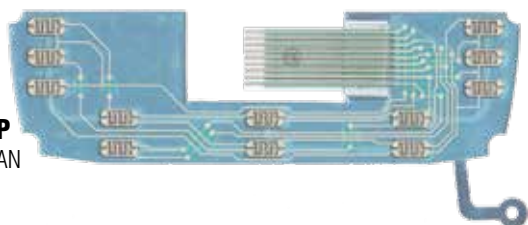

21.13.028
BRASTEMP LAVADORA
CLEAN ADORNO



ARANDELA REDONDA

- ARANDELA PARA EMBUTIR EM FORRO.
- PRATICIDADE E FÁCIL INSTALAÇÃO.
- ALTO FALANTE DE 5 E 6 POLEGADAS FULL RANGE OU COAXIAL.
- COR BRANCA.
- CORPO INJETADO EM ABS.
- PESO 650G OU 850G.
- DIMENSÕES: 23,7CM (DIAM.) X 7CM (PROFUND.)

01.43.009 5" 27W RMS (FULL RANGE)
 01.43.004 6" 27W RMS (FULL RANGE)
 01.43.003 6" 34W RMS (COAXIAL)

ARANDELA RETANGULAR

- ARANDELA PARA EMBUTIR EM FORRO.
- ELEGÂNCIA E FINO ACABAMENTO.
- ALTO FALANTE DE 6 POLEGADAS COM SUSPENSÃO E TWEETER DE 2 POLEGADAS.
- ACABAMENTO (FUNDO) BRANCO OU PRETO.
- CORPO INJETADO EM ABS.
- PESO 925G OU 1,7 KG.
- DIMENSÕES: 22 X 30,5 X 8CM (L X C X P).

BRANCA

01.43.000 - 94WMUSICAL - 47WRMS
 01.43.007 - 130WMUSICAL - 65WRMS
 01.43.008 - 160WMUSICAL - 80WRMS

Alto Falantes

01.15.002
A. F. ALNICO 1" 3/4 8R 3W C/ SUSP.



01.02.009
A. F. BLINDADO 2 X 4 3/4 8 OHMS 5W



01.02.010
A. F. BLINDADO 2 X 3 1/2 8 OHMS 1,5W



01.03.001
2" X 3" 1/2" 8Ω 5W



01.03.003
BLINDADO 2" X 3" 1/2 8 OHMS 3W TGT5690-01



01.03.002
2" X 3" 1/2" 16Ω 5W

Todos os nomes, logotipos de empresas e produtos citados neste catálogo são marcas registradas de suas respectivas corporações. A citação dos mesmos tem a única intenção de auxiliar nossos clientes na identificação de nossos produtos.



01.11.010
ALTO FALANTE FERRITE DUPLO 2" 1/2



01.11.008
3" 4Ω 15W



01.17.006
2 1/2" 8Ω 2.5W S/ SUSPENSÃO
MID RANGER



01.17.032
A.F FERRITE 6" 6 OHMS LOAA16A00023



01.17.033
A.F FERRITE 6" 6 OHMS 16PL06C8



01.17.005
A.F. FERRITE 2" 1/4 8R 0,5W S/ SUSP



01.17.007
ALTO FALANTE 2" X 8 OHM 0,5W



01.18.001
1 3/4" X 5 1/8" 8Ω 10W C/ ABAS E
SUSPENSÃO



01.02.007
2" 1/4" X 5" 8Ω C/ SUSPENSÃO



01.20.005
1 3/4" X 5" 8Ω 5W YDT0415-48AP.
C/ ABAS E SUSPENSÃO



01.20.002
1 3/4" X 6" 16R 5W C/ SUSPENSÃO
ABA VIRADA



01.20.030
3 3/16" X 1 3/16" 4R X 8W



01.20.012
1" 1/2" X 8" 16Ω 8W C/ SUSPENSÃO



01.20.029
1 3/16" X 7 3/16" 16R 10W YDT0420-4BP



01.20.024
A. F. BLINDADO 1 3/4 X 5 8 OHMS 10W

Todos os nomes, logotipos de empresas e produtos citados neste catálogo são marcas registradas de suas respectivas corporações. A citação dos mesmos tem a única intenção de auxiliar nossos clientes na identificação de nossos produtos que são compatíveis com os originais.



01.20.025
A. F. BLINDADO 1 3/8 X 5 1/4 8 OHMS 10W



01.20.019
1" X 5" 16Ω 10W C/ SUSPENSÃO YDT 415-E239 PHILIPS



01.20.026
A. F. BLINDADO 1 3/4 X 5 8 OHMS 5W



01.20.027
A. F. BLINDADO 1 3/4 X 5 16 OHMS 5W



01.20.020
2" X 5" 8Ω 10W C/ SUSPENSÃO E-227



01.20.013
2" X3 1/2" 8Ω 5W C/ SUSPENSÃO C/ ABAS YDT5090



01.21.004
2 3/4" X 4 1/4" 4Ω 1,5W C/ SUSPENSÃO



01.21.012
2 X 3 1/2 32Ω 5W C/ SUSPENSÃO



01.22.012
FERRITE 1 13/16" X 5 3/16" 8R 10W



01.22.001
1 3/4" X 5" 6Ω 15W C/ SUSPENSÃO



01.22.009
A. F. FERRITE 2 1/4 X 4 3/4 8 OHMS



01.22.010
A. F. FERRITE 1 3/8 X 5 5/8 8 OHMS 10W



01.22.011
A. F. FERRITE 3 3/4 X 1 6 OHMS 10W



01.34.001
A.F. TWEETER FERRITE 6R 2 " 25 W 5MM X 30MM



01.46.003
KIT ALTO FALANTE 4"



01.46.000
KIT ALTO FALANTE 5"





MÚLTIPLO 2 PCS
01.46.001
KIT ALTO FALANTE 6"/6,5"



MÚLTIPLO 2 PCS
01.46.002
KIT ALTO FALANTE 6X9"



MÚLTIPLO 2 PCS
01.47.000
ALTO FALANTE P/ HEADSETS
28M23CH-38BE 150HMS.



MÚLTIPLO 2 PCS
01.47.001
ALTO FALANTE P/ HEADSETS
2M01CH38BE 150HMS.



MÚLTIPLO 2 PCS
01.47.002
ALTO FALANTE P/ HEADSETS
FY27-5RSC-Q 150HMS.



MÚLTIPLO 2 PCS
01.32.004
ALTO FALANTE TWEETER ALL-TW250



01.32.005
A.F. TWEETER TW402



01.32.006
A.F. TWEETER DRIVE TW411



MÚLTIPLO 2 PCS
01.20.021
A.F. BLINDADO 8 OHMS 7W 1,5 X 2,3/4



MÚLTIPLO 2 PCS
01.32.002
TWEETER QUADRADO PIEZOELÉTRICO
300W 63 MM X 63 MM



ALTO FALANTE COM SUSPENSÃO

01.17.020 - 500 WATTS

- 15" DIÂMETRO
- 4Ω
- IMÃ 1" LARGURA
- DIÂMETRO 7 1/2"
- BORDA DE POLIURETANO

PREÇO POR CAIXA:
CAIXA COM DUAS UNIDADES

- 1 CAIXA
- 5 CAIXAS
- ACIMA DE 10 CAIXAS

OFERTA PARA ZERAR ESTOQUE



02.14.005
ANTENA DUPLA 5 EST. CABO F



02.03.033
ANTENA INTERNA ARBOR
HDTV/VHF/UHF C/ CABO 5M



02.03.022
ANTENA INTERNA RADAR



02.03.023
ANTENA INTERNA MINI-PARABÓLICA



02.03.027
ANTENA INTERNA STILLO



02.03.028
ANTENA INTERNA ARCOFLEX



02.03.029
ANTENA INTERNA BLACK



02.03.031
ANTENA INTERNA PIRAMIDE (SACO)



02.03.030
ANTENA EXTERNA BACIA



02.03.024
ANTENA EXTERNA LOG 8 ELEMENTOS



02.03.025
ANTENA EXTERNA LOG 17 ELEMENTOS



02.03.026
ANTENA EXTERNA DIGITAL

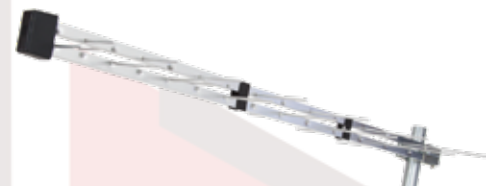

02.03.020
ANTENA EXTERNA UHF IMAGEVOX 14 ELEMENTOS

Todos os nomes, logotipos de empresas e produtos citados neste catálogo são marcas registradas de suas respectivas corporações. A citação dos mesmos tem a única intenção de auxiliar nossos clientes na identificação de nossos produtos que são compatíveis com os originais.



02.14.006
BASE INTERNA REDONDA



02.03.010
INTERNA. VHF/UHF
E FM YB1 027

OFERTA PARA ZERAR ESTOQUE



02.03.012
ANTENA INTERNA
AMPLIFICADA VHF/UHF/HDTV MDTV-703A



02.03.006
INTERNA AMPLIFICADA
VHF UHF HDTV E FM MXT-029



DTV-6

02.03.015

ANTENA DE TV DIGITAL AMPLIFICADA- INTERNA

- SUPORTA SINAIS FULL HD
- CAPACIDADE PARA RECEBER SINAIS 1080 E 1080P
- BANDAS DE FREQUÊNCIAS HDTV / UHF/ VHF /FM
- HASTES TELESCÓPICAS PARA MELHOR RECEPÇÃO EM VHF E FM
- COMPATÍVEL COM SINAIS DE TV DIGITAL E ANALÓGICOS
- CONTROLE DE AJUSTE DE GANHO
- GANHO DO AMPLIFICADOR: VHF=20DB / UHF=25DB
- FREQUÊNCIAS: VHF (BANDAS I, II E III - 47 - 230MHZ) UHF (BANDAS IV E V 470 - 862MHZ)
- CANAIS: VHF 2-12 E UHF 21 - 69
- LED INDICADOR DE LIGA/DESLIGA
- TENSÃO DE ENTRADA: AC 110 - 220V
- TENSÃO DE TRABALHO: DC 12V / 100MA(FONTE)
- IMPEDÂNCIA: 75 OHMS.



DTV-1N

02.03.014

ANTENA DE TV DIGITAL - INTERNA

- RECEBE SINAIS VHF/ UHF/ HDTV/ FM
- MELHOR SINAL DIGITAL , SUPORTA FULL HD (1080)
- BANDAS DE FREQUÊNCIAS:
VHF=47-230MHZ
UHF=470-862MHZ
- IMPEDÂNCIA: 75 OHMS
- CONECTOR F FEMÊA INCLUSO NO CABO

OFERTA PARA ZERAR ESTOQUE

Todos os nomes, logotipos de empresas e produtos citados neste catálogo são marcas registradas de suas respectivas corporações. A citação dos mesmos tem a única intenção de auxiliar nossos clientes na identificação de nossos produtos que são compatíveis com os originais.



HDII-11DN

02.03.016

ANTENA DE TV DIGITAL - INTERNA

- DESIGN ULTRA SLIM
- COR BLACK PIANO
- HASTES TELESCÓPICAS PARA MELHOR RECEPÇÃO EM VHF
- RECEBE SINAIS VHF/ UHF/ HDTV/ FM
- INDICADA PARA SINAL DIGITAL DE RÁDIO E TV
- MELHOR SINAL DIGITAL , SUPORTA FULL HD (1080)
- BANDAS DE FREQUÊNCIAS:
VHF=47~230MHZ
UHF=470~862MHZ
- CANAIS: VHF 2-12 E UHF 21-69
- IMPEDÂNCIA: 75 OHMS
- CONECTOR F FEMÊA INCLUSO NO CABO



DTVO-2D

02.03.017

ANTENA DE TV DIGITAL AMPLIFICADA- EXTERNA

- MELHORA O SINAL DA SUA REGIÃO
- KIT DE MONTAGEM E FIXAÇÃO EXTERNA INCLUSO PARA USO DOMÉSTICO OU EM AUTOMÓVEIS
- RECEBE SINAIS VHF/ UHF/ HDTV/ FM
- INDICADA PARA CARROS, CAMINHÕES, BARCOS E SACADAS.
- GANHO DO AMPLIFICADOR: VHF=20DB / UHF=25DB
- HASTES TELESCÓPICAS PARA MELHOR RECEPÇÃO EM VHF
- INDICADA PARA SINAL DIGITAL DE RÁDIO E TV
- MELHOR SINAL DIGITAL , SUPORTA FULL HD (1080)
- BANDAS DE FREQUÊNCIAS: VHF=47~230MHZ
UHF=470~862MHZ
- CANAIS: VHF 2-12 E UHF 21-69
- IMPEDÂNCIA: 75 OHMS



24.06.005
LBNF MONOPONTO
MS861B-9



24.06.006
LBNF MULTI PONTO
MS862-3 EMBAL. 2 PQS



24.06.004
LBNF BANDA KU -MS795



24.06.007
CONVERSOR PARABÓLICA
LNB KU-BAND UNIV. DUPLO.



24.06.008
CONVERSOR PARABÓLICA
LNB KU-BAND UNIV. QUADRUPL0



03.02.026 - CR.2016
03.02.027 - CR.2025
03.02.015 - CR.2032



03.02.022 - CR 2025 SUNICA
03.02.021 - CR2016 SUNICA
03.02.019 - CR2032 SUNICA



BATERIA GOLDEN POWER
03.02.020 - CR.2016
03.02.018 - CR.2025
03.02.025 - CR.2032



03.02.024
BATERIA CR2025
3V PANASONIC



03.01.035
KIT BATERIA P/ CONTROLE DE XBOX



BATERIA DE LITHIUM
03.02.029 - CR.2450
BLISTER C/ 1 PÇ



03.10.007
BATERIA 12V 23A
CAIXA COM 50 PEÇAS



03.10.001
PILHA ALCALINA 23A SUNKING CARTELA 5 PÇS



03.10.008
BATERIA 12V 23A ELGIN CARTELA C/ 5 PEÇAS



03.10.003
BATERIA A27 BLITER C/ 5 PEÇAS



03.10.005
BATERIA CR123A GOLDEN POWER



03.10.006
BATERIA DE LÍTIO CR123A 3V BLISTER C/ UMA



03.01.006
RECARREGÁVEL TEL. S/ FIO GP T107



03.01.030
BATERIA P/ TELEFONE S/ FIO 3,6V X 400MAH PLUG UNIVERSAL

**OFERTA PARA
ZERAR
ESTOQUE**



03.01.031
BATERIA P/TELEFONE S/FIO 3,6V X 600MAH PLUG UNIVERSAL



03.01.017
BATERIA GP60 AAA H3BMU PLUG UNIVERSAL



03.01.019
BATERIA P/ TELEFONE S/ FIO 2,4V X 300MAH PLUG UNIVERSAL



03.00.008
BATERIA 9V 6F22 NEW LEADER EXTRA HEAVY DUTY



03.00.001
BATERIA 9V GP 1604S COMUM



03.00.003
BATERIA 9V GP 1604G



03.00.006
BATERIA 9V GOLDEN POWER BLISTER



03.01.015
BATERIA TALK ABOUT MOTOROLA 3.6 X 700 MAH



03.11.005
BATERIA RECARREGÁVEL 3,6V 60 MA TAMBOR



03.11.007
BATERIA 3,6V X 2,25AH 8,1WH AM.



03.11.008
BATERIA 3,6V X 220 MA 8,0WH PT



03.11.009
BATERIA 3,6V X 2,25AH 8,1WH AZ

Todos os nomes, logotipos de empresas e produtos citados neste catálogo são marcas registradas de suas respectivas corporações. A citação dos mesmos tem a única intenção de auxiliar nossos clientes na identificação de nossos produtos que são compatíveis com os originais.

NOVO



24.01.074
SUPORTE PARA BATERIA CR2016/2025/2032

MÚLTIPLO 10 Pcs



03.00.002
CLIP 9V BS 036

MÚLTIPLO 10 Pcs



03.00.010
CLIP BATERIA TIPO T

MÚLTIPLO 10 Pcs



33.09.010
SUPORTE P/ PILHAS 2 X AA TIPO CANOA PRETO

MÚLTIPLO 10 Pcs



33.09.002
SUPORTE 2 PILHAS AA TIPO CANOA

MÚLTIPLO 10 Pcs



33.09.007
SUPORTE 4 PILHAS



03.04.014
PILHAS ALCALINA AA - BLISTER C/ 2 UNIDADE



03.04.015
PILHA RECARREGÁVEL AA 2500 MAH - BLISTER C/ 2



03.04.016
PILHA RECARREGÁVEL AA 2700 MAH - BLISTER C/ 2



03.06.023
PILHAS ALCALINA AAA - BLISTER C/ 2 UNIDADE



03.06.024
PILHA RECARREGÁVEL AAA 1000MAH - BLISTER C/ 2 UNIDADE



03.00.012
BATERIA ALCALINA 9V - BLISTER C/1 UNIDADE



03.02.030
BATERIA ALCALINA 1,5V LR44 CARTELA C/ 10 UNIDADE



03.11.006
BATERIA RECARREGÁVEL 9V 250 MAH - BLISTER C/ 1 UNIDADE

BUZZER CONTÍNUO
 01.44.001 - 3V
 01.44.002 - 5V
 01.44.003 - 6V
 01.44.004 - 9V
 01.44.005 - 12V
 01.44.006 - 24V
 01.44.007 - 30V



CABO ÓPTICO
 05.14.006 - 2MT
 05.14.007 - 3MT
 05.14.008 - 5MT



12.12.113
 ADAPTADOR HDMI MACHO +
 HDMI FÊMEA 90°



12.12.129
 ADAPTADOR EMENDA HDMI +
 HDMI FÊMEA



12.12.135
 ADAPTADOR HDMI FÊMEA + HDMI
 FÊMEA ARTICULADO



12.12.183
 ADAPTADOR HDMI MACHO + FÊMEA
 ARTICULADO



12.12.190
 ADAPTADOR MICRO HDMI + HDMI FÊMEA



05.16.154
 HDMI HIGH SPEED COM ETHERNET FLAT
 ESPECIFICAÇÕES:
 • SUPORTA 3D, 1080P E 4K, DEEP COLOR
 • CONECTORES E PLUGS GOLD
 • BLINDAGEM CONTRA INTERFERÊNCIA EXTERNA
 • CABO DE COBRE LIVRE DE OXIGÊNIO (OFC)
 • COMPRIMENTO: 1.8 METROS
 • QUANTIDADE: 1 UNIDADE POR EMBALAGEM
 (TIPO BLISTER)



05.16.156
 HDMI HIGH SPEED COM ETHERNET BLISTER
 ESPECIFICAÇÕES:
 • SUPORTA 3D, 1080P E 4K, DEEP COLOR
 • CONECTORES GOLD E PLUGS METÁLICOS
 • TRIPLA BLINDAGEM CONTRA INTERFERÊNCIA
 EXTERNA + MALHA DE NYLON
 TRANÇADO PARA PROTEÇÃO EXTERNA
 • CABO DE COBRE LIVRE DE OXIGÊNIO (OFC)
 • COMPRIMENTO: 1.8 METROS
 • QUANTIDADE: 1 UNIDADE POR EMBALAGEM
 (TIPO BLISTER)



12.12.114
 ADAPTADOR DVI + VGA



05.16.157
 HDMI HIGH SPEED COM ETHERNET SUPERIOR
 ESPECIFICAÇÕES:
 • SUPORTA 3D, 1080P E 4K, DEEP COLOR
 • CONECTORES GOLD E PLUGS METÁLICOS
 • TRIPLA BLINDAGEM CONTRA INTERFERÊNCIA
 EXTERNA + MALHA DE NYLON TRANÇADO
 PARA PROTEÇÃO EXTERNA
 • CABO DE COBRE LIVRE DE OXIGÊNIO (OFC)
 • COMPRIMENTO: 5 METROS
 • QUANTIDADE: 1 UNIDADE POR EMBALAGEM
 (TIPO CAIXA)

LEIA NA PÁGINA 1 DO
 CATÁLOGO SOBRE NOSSA
 POLÍTICA DE VENDA,
 TROCA E GARANTIA





CABO HDMI + DVI
05.16.128 3,0 MTS.....
05.16.129 5,0 MTS.....



05.16.127
CABO DVI + DVI - 5,0MTS



05.16.025
CABO HDMI 1,5M PRETO S/ FILTRO



05.16.111
CABO HDMI 2MTS 2.0 4K COM FILTRO



CABO HDMI 1.4 C/ FILTRO
05.16.027 PRETO 3MTS.....
05.16.028 PRETO 5MTS.....
05.16.131 PRETO 10MTS.....
05.16.130 PRETO 15MTS.....
05.16.167 PRETO 20MTS.....
05.16.183 PRETO 30MTS.....
05.16.184 PRETO 40MTS.....



CABO HDMI C/ FILTRO BLISTER
05.16.174 2MTS.....
05.16.175 3MTS - 4K 3D 2.0
05.16.176 10MTS.....

SALDÃO!

05.16.160
CABO HDMI FLAT 3MTS. PRETO BLISTER



12.12.170
EXTENSOR HDMI ATÉ 30 METROS VIA CABO DE REDE

Cabos para Áudio e Vídeo



05.16.062
1P 2 ST + JACK J 2 ST 1,80MTS NÍQUEL.
PT1509"



05.16.095
1P2 ST + P2 ST 1.80M PT DOURADA



05.16.185
CABO P2 4 FAIXAS + P2 4 FAIXAS 90°
VERMELHO



05.16.186
CABO P2 4 FAIXAS + J2 4 FAIXAS
VERMELHO

Todos os nomes, logotipos de empresas e produtos citados neste catálogo são marcas registradas de suas respectivas corporações. A citação dos mesmos tem a única intenção de auxiliar nossos clientes na identificação de nossos produtos que são compatíveis com os originais.



05.16.074
1RCA MACHO + 2RCA FÊMEA
0,20M PRETO NÍQUEL "Y" X6065 PRETO



05.16.075
1RCA MACHO + 2RCA FÊMEA
0,20M PRETO NÍQUEL "Y" X6065 AZUL



05.16.076
2RCA MACHO + 1RCA FÊMEA
0,20M AZUL NÍQUEL "Y" X6066 PRETO



05.16.077
2RCA MACHO + 1RCA FÊMEA
0,20M AZUL NÍQUEL "Y" X6066 AZUL



05.16.050
CABO 2RCA + P2ST, 1,80M DOURADO



05.16.179
CABO 1RCA MACHO + 1RCA MACHO
COAXIAL DIGITAL



05.16.165
CABO 2RCA 90° + 2RCA 180° C/TERRA
5MTS PRETO



05.16.069
CABO 2 + 2 RCA 5M PRETO



05.16.149
CABO 2+2 RCA 1,50M C/ TERRA PRETO



05.16.162
CABO MICROFONE CANON FÊMEA + P10
MONO 5MTS.



05.16.188
CABO DE MICROFONE CANON FÊMEA +
P-10 2MTS



05.12.066
CABO ADAPTADOR VGA
P/ TV SAMSUNG LCD



05.16.098
2RCA F X 1P2 STEREO NÍQUELADO
BC/VM



05.16.173
CABO 2RCA FÊMEA + P3 4
FAIXAS AMARELO E PRETO



05.16.168
CABO 1P3 X 2 RCA F VERM / BRANCA



05.16.117
CABO 3RCA F X 1P3 AV SAMSUNG



05.16.189
CABO P2 4 FAIXAS + 3RCA FÊMEA FIO
CINZA



05.16.191
CABO P2 4 FAIXAS + 3RCA FÊMEA FIO
PRETO



05.16.099
3RCA F X 1P4 STÉREO 0,17M
NÍQUELADO BORNE AZ/VD/VM
APLICAÇÃO: TV PLASMA / LED



05.16.190
CABO P2 4 FAIXAS + VÍDEO
COMPONENTES FIO PRETO



05.16.192
CABO P2 4 FAIXAS + VÍDEO
COMPONENTES FIO CINZA



05.16.172
CABO ADAPTADOR TV LD SAMSUNG
P2+P1 AV/V. COMP. PARALELO



05.16.180
CABO ADAPTADOR P3 MACHO + FONE E
MICROFONE



05.16.181
CABO ADAPTADOR P3 FÊMEA +
P2 FONE E MICROFONE



05.16.187
CABO ADAPTADOR P3 FÊMEA + P2 FONE E MIC
BRANCO



05.16.063
CABO ÁUDIO E VÍDEO PS1/PS2



05.16.100
3RCA + P2S C/ 4 FAIXAS



05.16.161
RCA - ÁUDIO E VÍDEO
ESPECIFICAÇÕES:
3 RCA X 3 RCA
PONTA GOLD
PLUG METÁLICO
EXCELENTE BLINDAGEM, DISPENSA O
USO DE FILTROS
COMPRIMENTO: 5 METROS
QUANTIDADE: 1 UNIDADE POR
EMBALAGEM
(TIPO BLISTER)



05.16.048
3 + 3RCA MACHO C/ COAXIAL 2 MTS
6MM



05.16.094
3RCA MACHO + 3RCA MACHO
1,8M DOURADO AM/BC/VM



05.16.170
CABO 3+3RCA 1,80M NÍQUEL
BLISTER



05.16.178
CABO 3RCA M X 3RCA M 1,00M NÍQUEL



05.16.101
3RCA + 3RCA 90°
1,5M NÍQUEL



VÍDEO COMPONENTE GOLD
05.16.049 2MTS.....
05.16.125 3MTS.....
05.16.126 5MTS.....



CABO 3+3RCA PROFESSIONAL C/
BLISTER
05.16.121 2MTS.....
05.16.122 3MTS.....



05.16.014
CABO 3+3 RCA 1,80M NÍQUELADO



05.12.002
MACHO "A" X FÊMEA "A" 1,80M



05.12.070
CABO USB AM + BM 10MTS. AZUL

Todos os nomes, logotipos de empresas e produtos citados neste catálogo são marcas registradas de suas respectivas corporações. A citação dos mesmos tem a única intenção de auxiliar nossos clientes na identificação de nossos produtos que são compatíveis com os originais.



05.12.081
CABO USB AM + AM 1,80M PRETO



05.12.003
CABO USB AM + BM 1,80M



05.12.147
CABO USB AM + BM 2,00M PRETO



05.12.094
CABO USB MACHO + USB 5 PINOS 5,00M



05.12.065
CABO EXTENSÃO USB AM + AF 30CM AZUL



05.12.101
CABO USB MINI + 2 RCA A/V SONY



05.12.169
CABO USB 3X1 IPHONE/V8/TIP-C SJX-09



05.12.170
CABO USB PHONE 5 SPEED TECIDO CB-5G-BZ



05.12.171
CABO USB TIPO-C PRETO OU BRANCO



05.12.190
CABO + USB V8 RAYON



05.12.191
CABO + USB V8 EMBORRACHADO



05.12.092
CABO USB + V8 SAMSUNG COLORIDO V8



05.12.063
CABO USB DADOS E CARREGADOR LG/ SONY-ERICSSON/NOKIA



05.12.096
CABO USB IPOD/IPAD DADOS



05.12.153
CABO USB IPHONE 4 DADOS



05.12.136
CABO P/ IPHONE 4/IPAD CHATO C/ RAYON DIVERSAS CORES



05.12.135
CABO P/ IPHONE 4/IPAD DIVERSAS CORES



05.12.188
CABO ADAPTADOR IPHONE PARA FONE P2



05.12.189
CABO ADAPTADOR IPHONE PARA FONE P2 E USB



05.12.097
CABO USB IPHONE 5



05.12.165
CABO USB 2X1 IPHONE 5/6 E V8



05.12.151
CABO USB 2 X 1 V8 + IPHONE 6



05.12.152
CABO USB IPHONE 5 DADOS



12.12.117
CABO ADAPTADOR PLUG P3
4 FAIXAS + USB A FÊMEA



05.12.053
CABO USB 5 PINOS + USB AF



05.12.124
CABO USB 3.0 P/HD E NOTE3 AZUL



05.12.112
CABO 3X1 USB MX IPHONE 4 / IPHONE 5
GALAXY S3 DIVERSAS CORES



05.12.090
MINI DISPLAY PORT P/ VGA FÊMEA



05.12.115
CABO CONECTOR IPAD P/ ADAPTADOR
VGA BRC



05.12.074
CABO ADAPTADOR USB AF + V8 AZUL
20CM



12.12.118
ADAPTADOR USB + LAN REDE



05.12.134
CABO ADAPTADOR
CONVERSOR USB 2.0 P/ SATA/IDE



12.12.156
ADAPTADOR USB A MACHO + A MACHO



12.08.030
EMENDA USB AF + AF



12.12.115
ADAPTADOR USB V8 + USBA F



12.12.116
ADAPTADOR USB 5PINOS V3 + USBA F



12.12.157
ADAPTADOR USB A MACHO + B MACHO



12.12.158
ADAPTADOR USB A FÊMEA + B MACHO



05.12.055
CABO HD 2USB MACHO + USB 5 PINOS



05.12.054
CABO HD 2USB MACHO + USB MACHO



05.12.126
CABO RABICHO 1 FÊMEA + 4 MACHOS
P4 5.5 X 2.1



ADAPTADOR HDMI PARA VGA
05.12.100 - 10CM



05.12.194
CABO POE 30 METROS



24.10.131
FONTE POE COMPACTA 12V 1A P/ACCESS POINT
ROTEADORES PCBA



05.12.195
CABO ADAPTADOR
DISPLAY PORT PARA VGA



05.12.196
CABO ADAPTADOR
DISPLAY PORT P/ HDMI



05.12.146
ADAPTADOR HDMI P/ VGA C/ ÁUDIO



05.12.128
ADAPTADOR VGA + 3 RCA SV



05.12.068
CABO Y VGA 1M + 2 FÊMEA PRETO



05.12.073
CABO ADAPTADOR
USB P/ RS232



05.12.161
CABO USB+PARALELO



05.12.142
CABO ADAPTADOR USB + RS232 + DB25M/DB9F



12.12.163
ADAPTADOR USB 2.0 + RS232
CONVERSOR



05.12.145
ADAPTADOR USB P/FONE E MIC



05.12.160
CABO HDB15 MACHO + HDB15 FÊMEA 25CM

Todos os nomes, logotipos de empresas e produtos citados neste catálogo são marcas registradas de suas respectivas corporações. A citação dos mesmos tem a única intenção de auxiliar nossos clientes na identificação de nossos produtos que são compatíveis com os originais.



05.12.098
CABO VGA PRETO CAPA AZUL 1,50M



05.12.050
CABO VGA BEGE C/ FILTRO - 10MTS



CABO VGA PRETO C/ FILTRO

- 05.12.032 - 1,80MTS
- 05.12.034 - 3MTS
- 05.12.049P - 5MTS
- 05.12.050P - 10MTS
- 05.12.051P - 15MTS
- 05.12.052P - 20MTS
- 05.12.058 - 40MTS

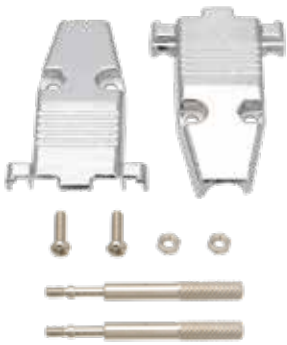

12.05.006
CAPA METÁLICA
DB9/HDB15 KIT LONGO



CAPA DB9/HDB15 PLÁSTICA
KIT LONGO
12.05.001 - PRETO
12.05.007 - CINZA



CAPA DB9/HDB15 PLÁSTICA
KIT CURTO
12.05.000 - PRETA
12.05.008 - CINZA

Cabos Chicote Para Som Automotivo



05.01.024
NEW CIVIC ATÉ 2011



05.01.043
RENAULT SANDERO



05.01.025
GM (COBALT/SPIN/ONIX)



05.01.026
HYUNDAI (HB20-VELOSTER-IX35)

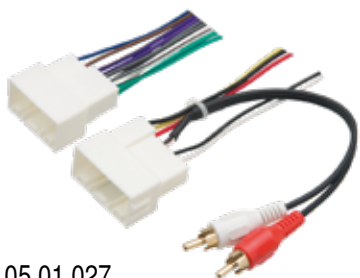

05.01.027
HYUNDAI
(HB20-IX350 COM ROSCA)



05.01.028
RENAULT (DUSTER-SANDERO-LOGAN)



05.01.029
NISSAN (MARCH)



05.01.030
GM - CAPTIVA

Todos os nomes, logotipos de empresas e produtos citados neste catálogo são marcas registradas de suas respectivas corporações. A citação dos mesmos tem a única intenção de auxiliar nossos clientes na identificação de nossos produtos que são compatíveis com os originais.



05.01.031
GM - NOVA S10 OU BLAZER



05.01.032
HONDA NEW FIT 2009/2011



05.01.033
HONDA NEW CIVIC / CITY



05.01.034
PEUGEOT 307



05.01.035
TOYOTA COROLLA-FIELDER-HILUX



05.01.036
FIC



05.01.037
16 VIAS



05.01.023
CHICOTE H-BUSTER PL 1400



05.01.015
CABO CHICOTE PIONNER 1550
P/ 16-04

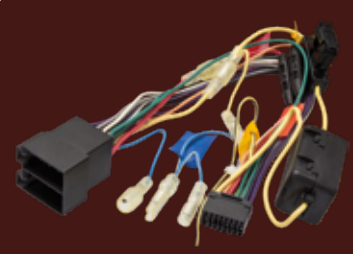

05.01.050
CABO CHICOTE PIONNER CL6562 C/
PORTA FUSÍVEL



05.01.051
CABO CHICOTE PIONNER
C/ RCA FÊMEA



05.01.052
CABO CHICOTE PIONNER



05.01.138
CHICOTE PARA SOM AUTOMOTIVO 16
VIAS



05.01.038
NEW CIVIC/CRV/FIT(2012)



05.01.039
FUSION/EDGE/FOCUS/F-150



05.01.040
NISSAN (MARCH/TIIDA)



05.01.041
TOYOTA (HYLUX/ETIOS/COR)



05.01.042
HYUNDAI/KIA - TODOS



05.01.044
AUDI-BMW-FORD-CITROEN

DISJUNTOR AUTOMOTIVO

- 39.01.003 50A
- 39.01.004 60A
- 39.01.005 70A
- 39.01.006 80A
- 39.01.008 100A
- 39.01.012 140A
- 39.01.013 150A
- 39.01.018 200A





05.10.114
CABO DE FORÇA 90°



05.10.163
CABO DE FORÇA TIPO 8 90° 1,80M



05.10.064
CABO DE FORÇA TIPO 8 FIO PP 2X0,75



05.10.115
CABO DE FORÇA PARALELO TIPO 8 1 METRO



05.10.070
FIO PARALELO 2X0,50MM



05.10.095
CABO DE FORÇA P/ FONTE DE NOTEBOOK



05.10.104
CABO FORÇA TRIPOLAR 20AMP. 3X2.5MM 1,80M



05.10.098
CABO TRIPOLAR PC FONTE 1,80M



05.10.105
CABO TRIPOLAR PADRÃO NOVO 3,00MT



05.10.099
TRIPOLAR 90° 2 P + T 3X0,75MM 1.5M INMETRO

OFERTA PARA ZERAR ESTOQUE



05.10.012
CABO DE FORÇA COMPUTADOR 1,8 M



CABO FORÇA C13/C14 10A
05.10.161 - 1,8M
05.10.162 - 3,0M



05.10.065
CABO RABICHO PARALELO 2X0,50 1,50M

Todos os nomes, logotipos de empresas e produtos citados neste catálogo são marcas registradas de suas respectivas corporações. A citação dos mesmos tem a única intenção de auxiliar nossos clientes na identificação de nossos produtos que são compatíveis com os originais.



05.10.111
CABO DE FORÇA RABICHO 2X0,75
CONECTOR PRETO 10A 250V



05.10.156
CABO DE FORÇA PP 2X0,75 10A 1,8MT



05.10.116
CABO DE FORÇA RABICHO 2X0,75 MM
2,5M 10A



05.10.013
FERRO PASSAR



05.10.014
FERRO PASSAR GE BLACK & DECKER



05.10.015
FERRO PASSAR WALLITA PASSA FIO



05.10.155
CABO DE FORÇA 2X0,75 C/ TERMINAL



05.10.102
BUCHA PASSA FIO

Cabo F / Coaxial / Rede / LAN/CFTV

05.03.000
F + BALOON CHAVEADO
SAÍDA 75/300 OHMS



05.03.005
F + RCA ENGATE RÁPIDO
COAXIAL 2,0MT NÍQUEL WM1166"



CABO COAXIAL RG.59
C/ CONECTOR COMPRESSÃO

- 05.03.007 - 2M
- 05.03.008 - 5M
- 05.03.009 - 10M
- 05.03.010 - 15M
- 05.03.011 - 20M



CABO COAXIAL RG.6
C/ CONECTOR COMPRESSÃO

- 05.03.012 - 2,00M
- 05.03.013 - 5,00M
- 05.03.014 - 10,00M
- 05.03.015 - 15,00M
- 05.03.016 - 20,00M



FIXA FIO
(100 PÇS)
29.00.005 - 6MM



38.18.004
CABO LAN/CFTV BRANCO
ROLO 100 MTS



05.19.006
CABO DE REDE
RJ 45 1,5 MT
AMARELO

05.19.001
CABO REDE
RJ45 CAT5E 2M
AZUL



CABO REDE
RJ45 CAT5E AZUL
05.19.002 - 3M

05.12.158
EXTENSOR
USB RJ45

CABO LAN/CFTV

38.18.000 - AZUL
38.18.002 - BRANCO

CAIXA COM 305 METROS



**OS TUBOS TERMO ENCOLHÍVEIS ATENDEM AS NORMAS STANDARD:
UL 224VW-1 E CSA C-UL C 22,2 OFT**

**SÃO PRODUZIDOS EM POLIOLEFINA FLEXÍVEL COM ENCOLHIMENTO
2X1.**

PRINCIPAIS PROPRIEDADES:

- **RETARDAR CHAMAS**
- **FLEXIBILIDADE**
- **ENCOLHIMENTO RÁPIDO**
- **ESTABILIDADE DE DESEMPENHO**

PRINCIPAIS UTILIZAÇÕES:

- **INDÚSTRIA ELETRÔNICA**
- **INDÚSTRIA AUTOMOBILÍSTICA**
- **BARRAMENTOS ELÉTRICOS**
- **COMUNICAÇÕES**
- **CHICOTES DE FIOS**
- **CONEXÕES**
- **FIOS ELÉTRICOS**

PROTEGEM CONTRA:

- **FERRUGEM DE HASTES METÁLICAS OU TUBOS**
- **CORROSÃO CAUSADA PELA UMIDADE**

**TAMBÉM É USADO CONTRA UMIDADE NA VERSÃO
DE ENCOLHIMENTO 3X1 COM ADESIVO INTERNO E
ENCOLHIMENTO 4X1 COM ADESIVO INTERNO**

38.13.001.....	1,0 MM PRETO 10 MTS
38.13.005.....	1,5 MM PRETO 10 MTS
38.13.009.....	2,0 MM PRETO 10 MTS
38.13.013.....	2,5 MM PRETO 10 MTS
38.13.017.....	3,0 MM PRETO 10 MTS
38.13.021.....	3,5 MM PRETO 10 MTS
38.13.025.....	4,0 MM PRETO 10 MTS
38.13.029.....	4,5 MM PRETO 10 MTS
38.13.033.....	5,0 MM PRETO 10 MTS
38.13.041.....	6,0 MM PRETO 10 MTS
38.13.049.....	7,0 MM PRETO 10 MTS
38.13.057.....	8,0 MM PRETO 10 MTS
38.13.065.....	9,0 MM PRETO 10 MTS
38.13.073.....	10 MM PRETO 10 MTS
38.13.081.....	11 MM PRETO 10 MTS
38.13.085.....	12 MM PRETO 10 MTS
38.13.089.....	13 MM PRETO 10 MTS
38.13.093.....	14 MM PRETO 10 MTS
38.13.097.....	15 MM PRETO 10 MTS
38.13.101.....	16 MM PRETO 10 MTS
38.13.105.....	17 MM PRETO 10 MTS
38.13.109.....	18 MM PRETO 10 MTS
38.13.113.....	20 MM PRETO 10 MTS

38.14.001.....	1,0 MM PRETO 200 MTS
38.14.005.....	1,5 MM PRETO 200 MTS
38.14.009.....	2,0 MM PRETO 200 MTS
38.14.003.....	2,5 MM PRETO 200 MTS
38.14.017.....	3,0 MM PRETO 200 MTS
38.14.021.....	3,5 MM PRETO 200 MTS
38.14.025.....	4,0 MM PRETO 200 MTS
38.14.029.....	4,5 MM PRETO 100 MTS
38.14.033.....	5,0 MM PRETO 100 MTS
38.14.041.....	6,0 MM PRETO 100 MTS
38.14.049.....	7,0 MM PRETO 100 MTS
38.14.057.....	8,0 MM PRETO 100 MTS
38.14.065.....	9,0 MM PRETO 100 MTS
38.14.073.....	10 MM PRETO 100 MTS
38.14.081.....	11 MM PRETO 100 MTS
38.14.085.....	12 MM PRETO 100 MTS
38.14.089.....	13 MM PRETO 100 MTS
38.14.093.....	14 MM PRETO 100 MTS
38.14.097.....	15 MM PRETO 100 MTS
38.14.101.....	16 MM PRETO 100 MTS
38.14.105.....	17 MM PRETO 100 MTS
38.14.109.....	18 MM PRETO 100 MTS
38.14.117.....	20 MM PRETO 100 MTS
38.14.102.....	25 MM PRETO 50 MTS

Todos os nomes, logotipos de empresas e produtos citados neste catálogo são marcas registradas de suas respectivas corporações. A citação dos mesmos tem a única intenção de auxiliar nossos clientes na identificação de nossos produtos que são compatíveis com os originais.

MEDIDA 1.0MM

- 38.13.229 - TRANSPARENTE
- 38.13.114 - BRANCO
- 38.13.137 - AMARELO
- 38.13.160 - AZUL
- 38.13.206 - VERDE
- 38.13.183 - VERM.

MEDIDA 1.5MM

- 38.13.230 - TRANSPARENTE
- 38.13.115 - BRANCO
- 38.13.138 - AMARELO
- 38.13.161 - AZUL
- 38.13.207 - VERDE
- 38.13.184 - VERM.

MEDIDA 2.0MM

- 38.13.231 - TRANSPARENTE
- 38.13.116 - BRANCO
- 38.13.139 - AMARELO
- 38.13.162 - AZUL
- 38.13.208 - VERDE
- 38.13.185 - VERM.

MEDIDA 2.5MM

- 38.13.232 - TRANSPARENTE
- 38.13.117 - BRANCO
- 38.13.140 - AMARELO
- 38.13.163 - AZUL
- 38.13.209 - VERDE
- 38.13.186 - VERM.

MEDIDA 3.0MM

- 38.13.233 - TRANSPARENTE
- 38.13.118 - BRANCO
- 38.13.141 - AMARELO
- 38.13.164 - AZUL
- 38.13.210 - VERDE
- 38.13.187 - VERM.

MEDIDA 3.5MM

- 38.13.234 - TRANSPARENTE
- 38.13.119 - BRANCO
- 38.13.142 - AMARELO
- 38.13.165 - AZUL
- 38.13.211 - VERDE
- 38.13.188 - VERM.

MEDIDA 4.0MM

- 38.13.235 - TRANSPARENTE
- 38.13.120 - BRANCO
- 38.13.143 - AMARELO
- 38.13.166 - AZUL
- 38.13.212 - VERDE
- 38.13.189 - VERM.

MEDIDA 4.5MM

- 38.13.236 - TRANSPARENTE
- 38.13.121 - BRANCO
- 38.13.144 - AMARELO
- 38.13.167 - AZUL
- 38.13.213 - VERDE
- 38.13.190 - VERM.

MEDIDA 5.0MM

- 38.13.237 - TRANSPARENTE
- 38.13.122 - BRANCO
- 38.13.145 - AMARELO
- 38.13.168 - AZUL
- 38.13.214 - VERDE
- 38.13.191 - VERM.

MEDIDA 6.0MM

- 38.13.238 - TRANSPARENTE
- 38.13.123 - BRANCO
- 38.13.146 - AMARELO
- 38.13.169 - AZUL
- 38.13.215 - VERDE
- 38.13.192 - VERM.

MEDIDA 8.0MM

- 38.13.125 - BRANCO
- 38.13.148 - AMARELO
- 38.13.171 - AZUL
- 38.13.217 - VERDE
- 38.13.194 - VERM.

MEDIDA 9.0MM

- 38.13.126 - BRANCO
- 38.13.149 - AMARELO
- 38.13.172 - AZUL
- 38.13.218 - VERDE
- 38.13.195 - VERM.

MEDIDA 10MM

- 38.13.127 - BRANCO
- 38.13.150 - AMARELO
- 38.13.173 - AZUL
- 38.13.219 - VERDE
- 38.13.196 - VERM.

MEDIDA 12MM

- 38.13.129 - BRANCO
- 38.13.152 - AMARELO
- 38.13.221 - AZUL
- 38.13.175 - VERDE
- 38.13.198 - VERM.

MEDIDA 14MM

- 38.13.131 - BRANCO
- 38.13.154 - AMARELO
- 38.13.177 - AZUL
- 38.13.223 - VERDE
- 38.13.200 - VERM.

MEDIDA 15MM

- 38.13.132 - BRANCO
- 38.13.155 - AMARELO
- 38.13.178 - AZUL
- 38.13.224 - VERDE
- 38.13.201 - VERM.

MEDIDA 16MM

- 38.13.133 - BRANCO
- 38.13.156 - AMARELO
- 38.13.179 - AZUL
- 38.13.225 - VERDE
- 38.13.202 - VERM.

MEDIDA 18MM

- 38.13.135 - BRANCO
- 38.13.158 - AMARELO
- 38.13.181 - AZUL
- 38.13.227 - VERDE
- 38.13.204 - VERM.

MEDIDA 20MM

- 38.13.136 - BRANCO
- 38.13.159 - AMARELO
- 38.13.182 - AZUL
- 38.13.228 - VERDE
- 38.13.205 - VERM.

**EMBALAGEM
COM 10 MTS**



PISTOLA DE SOPRO TÉRMICO
C/ CONTROLE DE TEMPERATURA
18.12.020 - 127V
18.12.021 - 220V



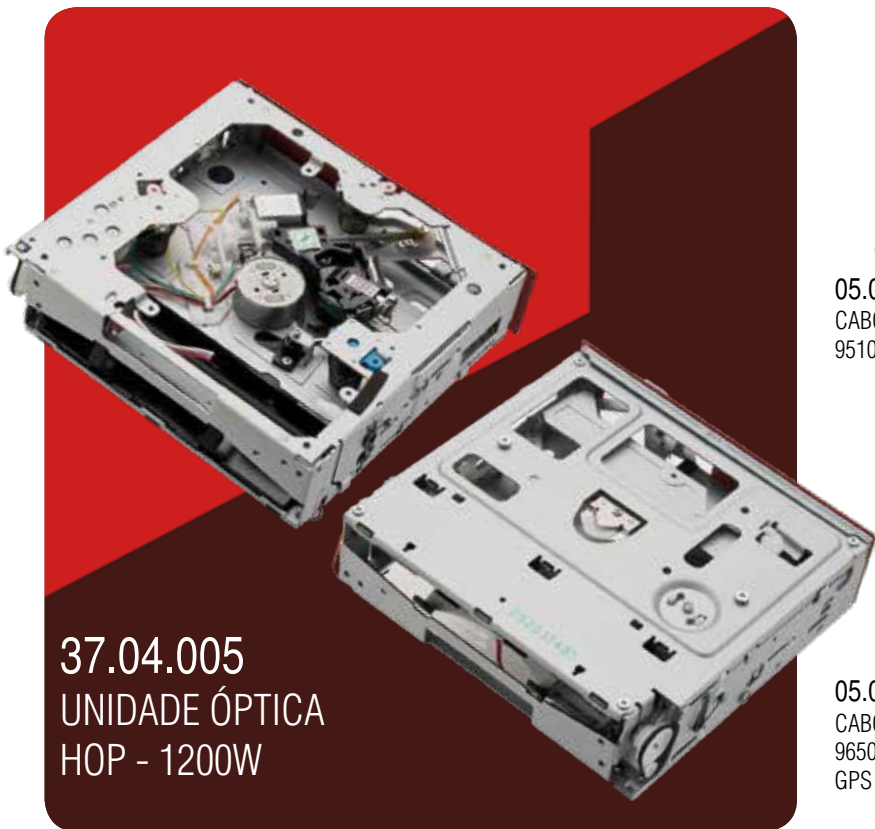

37.04.005
UNIDADE ÓPTICA
HOP - 1200W



05.09.023
CABO FLAT H BUSTER HBD 9560 AVN
9510 / 9540



05.09.026
CABO FLAT H BUSTER 9500 / 9550 /
9600 / PHILIPS CED750 / 755 ORIGINAL



05.09.038
CABO FLAT H BUSTER HBD / 9610 /
9650 / 9510 / 9540 / 9560 / 9570 C/
GPS ORIGINAL



05.09.028
CABO FLAT POSITRON SP6110 / 6120
ORIGINAL



05.09.024
CABO FLAT DVD BOOSTER BMTV 9750 /
7680 MOD. UTILIZADOS: BOOSTER
BMTV 9750DVD / BMTV 7950 DVDUSBT
/ BV 9996BT / PD 77BT / PD 76BT /
BMTV 7680 / ISDB TV766 /
ORANGE 7003 GPS / BOSS 9990



05.09.027
CABO FLAT PIONEER VASCULANTE AVH P5000



05.09.034
CABO FLAT PIONEER AVH P5000 / 5050 / 5080 / 5100 /
5150 / 5180/DVD ORIGINAL



05.09.025
CABO FLAT DVD NAPOLI 9484 / 7708 / 7709 / 7960 /
7940 / 7785 / 7789 / 9696 / 9797 PYRAMID PD 76/77
CYBER CYBD001 ORIGINAL

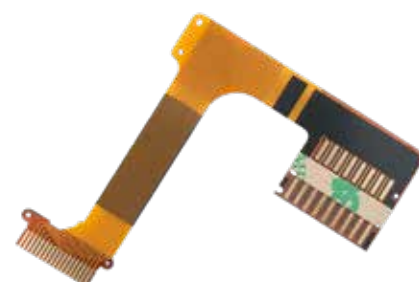

05.09.030
CABO FLAT PIONEER DEH P6800 / 6850 / 6880 / 7800 /
7880 / 8850 / (XNP 7026) TODA LINHA 8 ORIGINAL



05.09.041
FLAT CABLE PIONEER AVH 4250/4280

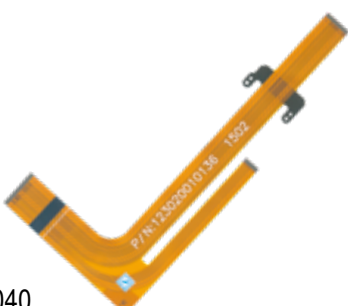

05.09.040
FLAT CABLE PIONEER AVH 3550/3580/AVH 3580 DVD



05.09.042
CABO FLAT PIONEER AVH-P 7750/7780
ORIGINAL

Todos os nomes, logotipos de empresas e produtos citados neste catálogo são marcas registradas de suas respectivas corporações. A citação dos mesmos tem a única intenção de auxiliar nossos clientes na identificação de nossos produtos que são compatíveis com os originais.



05.09.043
CABO FLAT PIONEER 1230 20 000 180 ORIGINAL



05.09.037
CABO FLAT NAPOLI DVD TV 7887 / 7997
BT / 7183 BT 36 VIAS 16,1 CM ORIGINAL



05.09.001
AIWA / PIONNER 8X X 63 MM CURVO

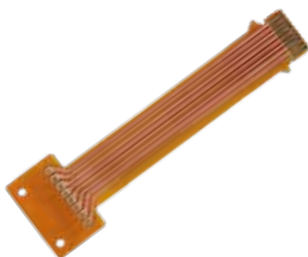

05.09.002
AIWA / PIONNER 8 X 65,0MM



05.09.003
AIWA / PIONNER 8 X 75,0MM



05.09.004
AIWA / PIONNER 8 X 79,0MM

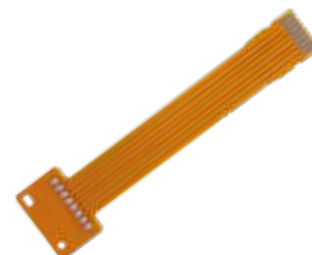

05.09.005
AIWA / PIONNER 8 X 85,0MM



05.09.044
CABO FLAT POSITION 6900

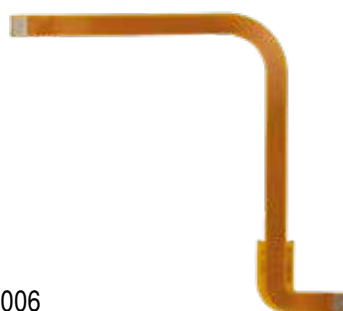

05.09.006
GRADIENTE 10 VIAS



05.09.007
KENWOOD 13 VIAS



05.09.010
KENWOOD 13 VIAS X 150MM

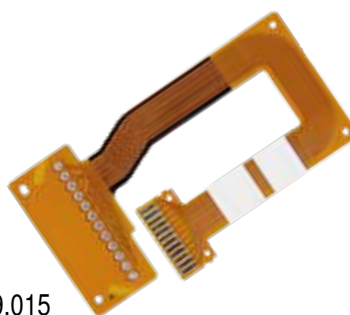

05.09.015
PIONNER 12 VIAS



05.09.018
PIONNER 22 VIAS X 38 VIAS



05.09.020
SONY 14 VIAS X 75MM



05.09.021
SONY 18 VIAS X 70MM

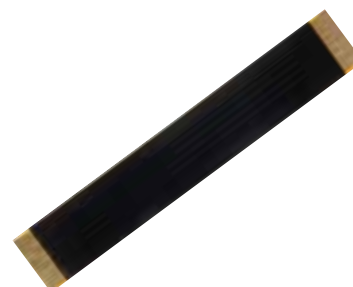

05.09.022
SONY 24 VIAS X 75MM

Cabo Flat Contato Comum

3 VIAS	
05.06.001	7.0 X 1.25 MM.....
6 VIAS	
05.06.004	6 X 9.0 X 1.00 MM.....
05.06.005	6 X 10.0 X 1.25 MM.....
05.06.006	6 X 14.0 X 1.25 MM.....
7 VIAS	
05.06.013	7 X 12.0 X 1.25 MM.....
05.06.014	7 X 15.0 X 1.25 MM.....
05.06.015	7 X 22.0 X 1.25 MM.....
05.06.016	7 X 27.0 X 1.25 MM.....
05.06.017	7 X 34.0 X 1.25 MM.....
9 VIAS	
05.06.022	9 X 13.0 X 1.25 MM.....
05.06.023	9 X 18.0 X 1.25 MM.....

11 VIAS	
05.06.031	11 X 12.0 X 1.25 MM.....
05.06.033	11 X 22.0 X 1.25 MM.....
05.06.034	11 X 23.0 X 1.25 MM.....
12 VIAS	
05.06.036	12 X 10.0 X 1.25 MM.....
05.06.038	12 X 11.0 X 1.25 MM.....
05.06.039	12 X 15.5 X 1.25 MM.....
05.06.040	12 X 20.0 X 1.25 MM.....
13 VIAS	
05.06.046	13 X 11.0 X 1.25 MM.....
15 VIAS	
05.06.058	15 X 9.5 X 1.25 MM.....
05.06.061	15 X 16.0 X 1.25 MM.....



17 VIAS	
05.06.072	17 X 14.0 X 1.25 MM.....
05.06.073	17 X 23 X 1.25 MM.....
18 VIAS	
05.06.075	18 X 16.0 X 1.25 MM.....
20 VIAS	
05.06.087	20 X 24.0 X 1.25 MM.....
23 VIAS	
05.06.093	23 X 20.0 X 1.25 MM.....
24 VIAS	
05.06.100	24 X 20 X 0,50 MM.....

05.06.285	80VX45CM X 0,5 LIN HA PFL TV PHILIPS.....	80 VIAS	R\$ 18,00
-----------	---	----------------	------------------

Cabo Flat Contato Invertido

4 VIAS	
05.08.002	4 X 34.5 X 1.25 MM.....
6 VIAS	
05.08.003	6 X 18.0 X 1.25 MM.....
05.08.004	6 X 23.0 X 1.25 MM.....
05.08.006	6 X 32.0 X 1.25 MM.....
7 VIAS	
05.08.008	7 X 14.0 X 1.25 MM.....
05.08.007	7 X 8.0 X 1.25 MM.....

12 VIAS	
05.08.013	12 X 15.5 X 1.25 MM.....
13 VIAS	
05.08.014	13 X 14.0 X 1.25 MM.....
05.08.016	13 X 27.0 X 1.25 MM.....
14 VIAS	
05.08.018	14 X 23.0 X 1.25 MM.....
05.08.019	14 X 28.0 X 1.25 MM.....

15 VIAS	
05.08.023	15 X 10.0 X 1.25 MM.....
05.08.024	15 X 20.0 X 1.25 MM.....
16 VIAS	
05.08.027	6 X 22.0 X 1.00 MM.....
19 VIAS	
05.08.032	19 X 21.0 X 1.25 MM.....
24 VIAS	
05.08.041	24 X 6.7 X 0,5 MM.....

Cabo Flat Blindagem Alumínio

05.00.000
CABO FLAT BLINDAGEM ALUMÍNIO 7 X 22,0 X 1,00MM



Cabo Flat Contato Comum

5 VIAS	
05.06.002	21.0 X 1.25 MM.....
7 VIAS	
05.06.010	7 X 9.0 X 1.25 MM.....
05.06.011	7 X 10.5 X 1.25 MM.....
05.06.012	7 X 11.0 X 1.25 MM.....

9 VIAS	
05.06.021	9 X 10.0 X 1.25 MM.....
10 VIAS	
05.06.028	10 X 17.0 X 1.25 MM.....
05.06.029	10 X 32.0 X 1.25 MM.....

11 VIAS	
05.06.032	11 X 13.0 X 1.25 MM.....
19 VIAS	
05.06.080	19 X 32 X 1,25 MM.....
21 VIAS	
05.06.089	21 X 55.0 X 1.25 MM.....

Cabo Flat Contato Invertido

4 VIAS	
05.08.001	4 X 25.0 X 1.25 MM.....
8 VIAS	
05.08.009	8 X 46.0 X 1.25 MM.....
05.08.010	8 X 55.0 X 1.25 MM.....

9 VIAS	
05.08.011	9 X 5.0 X 1.25 MM.....
10 VIAS	
05.08.012	10 X 10.0 X 1.25 MM.....
13 VIAS	
05.08.015	13 X 22.0 X 1.25 MM.....

14 VIAS	
05.08.017	14 X 16.0 X 1.25 MM.....
20 VIAS	
05.08.033	20 X 20.0 X 1.25 MM.....



**CABO EXTENSÃO FONE/FAX
RJ 11 6X4
10M HRBB-4CP+P-10MBK**

■ **PRETO**

□ **BRANCO**

■ **CINZA**

- 05.18.025 - 2M
- 05.18.027 - 5M
- 05.18.029 - 10M

- 05.18.026 - 2M
- 05.18.028 - 5M
- 05.18.030 - 10M

- 05.18.032 - 2M
- 05.18.034 - 5M
- 05.18.033 - 10M

OFERTA

05.18.035
CABO P/ TEL. 2 VIAS BEGE 1,5 M



- CABO ESPIRAL PARA MONO FONE**
- 05.17.000 - BEGE
 - 05.17.001 - BCO.
 - 05.17.003 - CINZA
 - 05.17.004 - PRETO

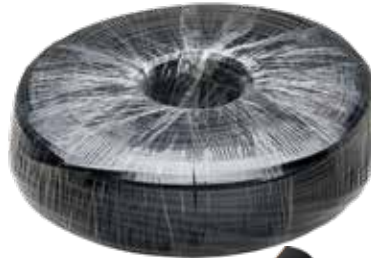

- CABO CHATO TELEFONE 4V
ROLO 305 METROS**
- 38.15.000 - PRETO
 - 38.15.001 - BRANCO
 - 38.15.002 - CINZA



- CABO CHATO TELEFONE 4V
ROLO 100 METROS**
- 38.15.005 - BRANCO
 - 38.15.006 - CINZA
 - 38.15.007 - PRETO

Plug Modular



- 12.00.016
ADAPTADOR MODULAR
2 CONTATOS**



- 12.16.004
PLUG MODULAR RJ 45
BLINDADO**



- 12.16.003
PLUG MODULAR RJ45 YH
012 8P8C**



- 12.16.005
PLUG MODULAR 6 X 4
RJ 11**



- CAPA P/ RJ45**
- 12.16.000 - AZUL
 - 12.16.007 - CINZA
 - 12.16.008 - VERMELHO



- 12.00.045
EMENDA RJ 11 YH 201 6PC
X 4PC**



- 12.00.047
EMENDA RJ45 YH 201 8P8C**



- 12.00.046
ADAPTADOR T2 FÊMEA X
1MACHO RJ.11.YH 202 6P4C**



- 12.00.048
ADAPTADOR T2 1MACHO +
2 FÊMEAS RJ 45**



- 12.00.049
ADAPTADOR T3 FÊMEA +
1 MACHO RJ11**

**OFERTA PARA
ZERAR
ESTOQUE**



- 40.01.000
FILTRO ADSL SIMPLES**



- 40.01.001
FILTRO ADSL DUPL0**



- 10.32.000
AMPOLA DOURADA**

Todos os nomes, logotipos de empresas e produtos citados neste catálogo são marcas registradas de suas respectivas corporações. A citação dos mesmos tem a única intenção de auxiliar nossos clientes na identificação de nossos produtos que são compatíveis com os originais.

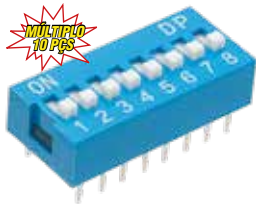

CHAVE DIP SWITCH
10.34.003 4 VIAS
10.34.007 8VIAS



10.03.000
2T HASTE 11,0MM HNS 1S ON OFF



10.03.009
2T HASTE 11,0MM KN 1021 ON OFF



10.03.008
2T HASTE 11,0MM MTS 101



10.03.007
3T 3POS HASTE 11,0MM MTS 103



10.03.010
3T HASTE 11,0MM KN 1121 ON ON



10.03.011
3T HASTE 11,0MM KN 1122 ON OFF ON



3T C NEON ASW 13D
10.03.016 - AZ
10.03.017 - VM
10.03.018 - VD
10.03.019 - AM



10.03.001
3T HASTE 11,0MM MTS 102



10.03.012
4T HASTE 11,0MM KN 1221 ON OFF



10.03.013
6T HASTE 11,0MM KN 1321 ON OFF ON



10.03.015
6T HASTE 11,0MM KN 223 ON OFF ON PULSANTE 2 LADO



10.04.000
6T HASTE 11,0MM MTS 202



10.05.000
6T HASTE 11,0MM MTS 203



10.03.020
6T HASTE 11,0MM ON ON



GANGORRA **MINI** 2P 2T 10A
10.30.000 - VM
10.30.002 - PT



10.30.010
18,8 X12,7 2T NA PULSANTE PT



10.30.001
21 X15MM 2T PRETO

Todos os nomes, logotipos de empresas e produtos citados neste catálogo são marcas registradas de suas respectivas corporações. A citação dos mesmos tem a única intenção de auxiliar nossos clientes na identificação de nossos produtos que são compatíveis com os originais.



10.07.001
21 X15MM 3T 3POS 2 PT



10.06.001
21 X15MM 3T PT



10.06.003
21 X15MM 3T VM



10.06.004
CHAVE L/D UNIP. INV.
2AMP/8AMP-250VAC VERDE



21 X15MM 4T
10.08.000 - PT 10.08.002 - VD
10.08.001 - AZ 10.08.003 - VM



10.31.000
21 X24,3MM 6T 2POS 6T PT



10.09.000
21,2X15,3MM 6T PT



21,5X15MM 3T
10.06.007 - AZ
10.06.008 - VD
10.06.009 - VM



10.30.012
23X23MM 2T PT ROSCA



CHAVE GANGORRA
6A 250V 3T REDONDA
10.06.011 - VERMELHO
10.06.013 - AZUL
10.06.014 - VERDE



10.06.012
CHAVE GANGORRA REDONDA PRETA 2T



10.33.000
DUPLA 2 POS 6 TERMINAIS 15A 250 V
20A 127V - 25X21,5X20



31,5X16,7MM 2T
10.30.016 - S MARCAÇÃO
10.30.015 - C MARCAÇÃO



10.30.017
31,5X16,7MM 2T VM 6/10A 250V



CHAVE GANGORRA
10.06.017 - VERDE
10.06.018 - AZUL
10.06.019 - VERMELHO

CHAVE GANGORRA
2P 4 TERMINAIS
33X25MM 4T
10.08.004 - PT

10.08.005 - AZ
10.08.006 - VD
10.08.007 - VM



10.12.008
6T S ALAV C GRAV 110/220 C FIX S
ROSCA - GDE

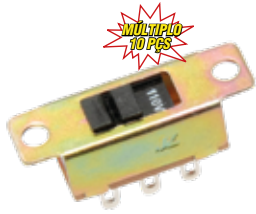

10.12.009
CHAVE HH - PEQ



10.12.011
CHAVE HH 110/220 6T PRETA



10.12.035
CHAVE HH 127/220 S/
MARCAÇÃO 3 TERM



10.12.026
CHAVE HH 127/220 6TERM. S/
MARCAÇÃO

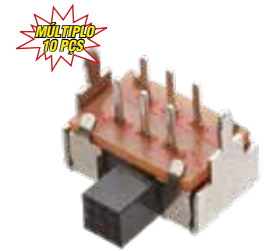

10.12.010
CHAVE HH C/ALAV. 2P 6T 90°



10.12.030
CHAVE HH MINI 90° 6
TERMINAIS

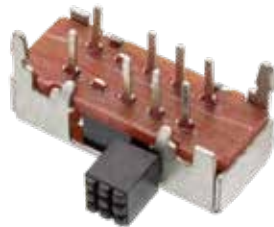

10.12.028
CHAVE HH PEQ 90° 8
TERMINAIS



10.12.041
CHAVE HH PEQ 90° 6 TERM.
ALAV. PLAST.

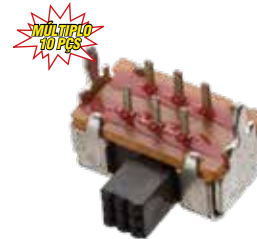

10.12.013
CHAVE HH 6 T C/ ALAVANCA
90°



10.12.015
CHAVE HH C/ ALAVANCA 3T
PRETA

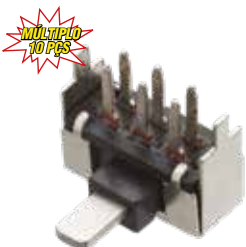

10.12.016
CHAVE DE FUNÇÕES
C/ ALAVANCA 6T 2P 90°

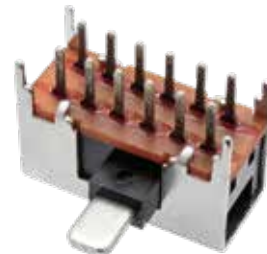

10.12.036
CHAVE HH 90° 12 TERMINAIS
ALAV. METAL

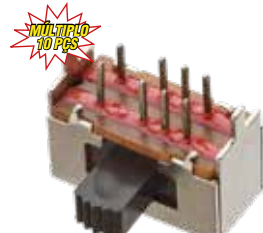

10.12.017
CHAVE DE FUNÇÕES
C/ ALAVANCA 8T 3P 90°



10.12.039
CHAVE HH 90° 12 TERM. ALAV.
PLÁSTICA

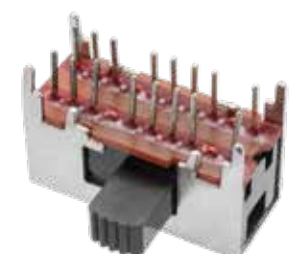

10.12.032
CHAVE HH 90° 16 TERM. 3 POS.
ALAV. PLAST.



10.12.037
CHAVE HH 90° 6 TERM. ALAV.
PLÁSTICA



10.12.029
CHAVE HH 90° 6 TERM. ALAV.
PLÁSTICA



10.12.040
CHAVE HH 90° 6 TERM. ALAV.
PLÁSTICA



10.12.031
CHAVE HH 90° 6 TERM. ALAV.
P/ KNOB

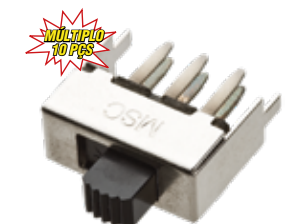

10.12.022
CHAVE FUNÇÕES
C/ ALAVANCA CURTA



10.12.033
CHAVE HH 8 TERMINAIS 3
POSIÇÕES

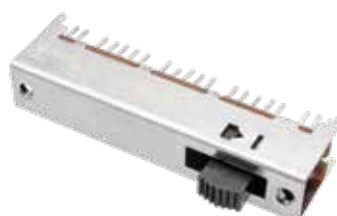

10.12.027
CHAVE HH 40 TERM. 4 POS.
ALAV. PLÁSTICA



10.12.038
CHAVE HH 10 TERM. 4 POS.
ALAV. METAL



10.12.024
CHAVE DE FUNÇÕES
16T 3P EIXO INVERTIDO



10.12.034
CHAVE HH 24 TERM. 3POS.
ALAV. METAL

**MULTIPLIO
70 PIS**

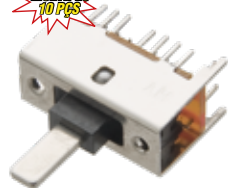

10.12.025
CHAVE DE FUNÇÕES
C/ ALAV. 16T. 3 POSIÇÕES

NOVO



10.18.020
CHAVE MICRO SWITCH
C/ ALAVANCA E RABICHO



10.18.001
5 AMP 1/2HP 125/250VAC ALAV.
56X4MM R.8 MICRO



10.18.004
12 AMP 1/2HP 125/250VAC ALAV.
60X4MM DA7 6/1 CO60



10.18.005
15 AMP 1/2HP 125/250VAC
ALAV. 13X4MM R17/1



10.18.006
15 AMP 1/2HP 125/250VAC
ALAV. 27X4MM R161/1



10.18.011
15 AMP 1/2HP 125/250VAC
ALAV. 17X4MM KW-7-1



10.18.014
16,2X9,6X6,7 C HASTE CURVA
KW11 3Z3



10.18.013
16,2X9,6X6,7 C HASTE KW11
3Z2



10.18.012
1A 125V 12,6X5,7X6,5 ALAV
1300 KW 10B



10.18.000
CHAVE MICRO SWITCH "DUPLA" "MINI"



10.18.018
28 X9,2X10,0 C HASTE 27MM

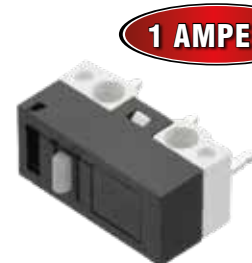

10.19.007
12,9 X5,6X 6,5 S HASTE

1 AMPERE

2 AMPERES



10.19.012
CHAVE MICRO SWITCH MINI 2A
KW10-ZOP



10.18.015
20 X9,6X6,7 C HASTE ROLDANA KW11
3Z 5A



10.19.008
20X9,6X6,7 S HASTE KW.11.3Z1



10.19.009
28 X9,2X10,0 S HASTE KW11 7 1 CZ



10.19.003
CHAVE MICRO SWITCH MICROONDAS
15AMP - NA GALANZ



10.19.011
CHAVE MICRO SWITCH 15A 250V PRETA



10.19.013
CHAVE MICRO SWITCH 16A VERDE



10.19.014
CHAVE MICRO SWITCH P/ FRITADEIRA
ELÉTRICA

Todos os nomes, logotipos de empresas e produtos citados neste catálogo são marcas registradas de suas respectivas corporações. A citação dos mesmos tem a única intenção de auxiliar nossos clientes na identificação de nossos produtos que são compatíveis com os originais.



10.26.054
CHAVE TACTIL SMD 5,0 X 5,0
KNOB 1.6MM 4T. 180°



10.26.065
CHAVE TACTIL SMD 4 TERM.
180° 6 X 3 KNOB 9MM ESE-
11MV9T



10.26.007
2 TERM. 6X6MM - 5MM

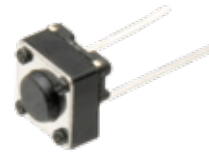

10.26.006
2 TERM. 6X6MM - 4,3MM



10.26.038
2 TERM. CURTO 180° 6 X 6
KNOB 5MM



10.26.008
2 TERM. 6X6MM KNOB 7MM



10.26.009
2 TERM. 6X6MM KNOB 9,5MM



10.26.047
2 TERM. 180° 9 X 13MM
SKRCACD010



10.26.024
180 GR 3X6X 5 MM 2T 180
KFC A06



10.29.020
CHAVE TACTIL 6,0 X 6,0 2
TERM. KNOB 4,3MM 90°



10.29.014
2 TERM. 6 X 6 MM KNOB 5MM



10.29.002
2 TERM. 6X6MM KNOB 5MM
FIX. 10MM



10.29.003
CHAVE TOQUE EVQQBH 06T C/
SUPORTE 10MM



10.29.004
CHAVE TOQUE 6,0 X 6,0
KNOB 6,0MM



10.29.005
2 TERM. 6X6MM KNOB 7MM
FIX. 13MM



10.29.007
2 TERM. 6 MM X 6MM, KNOB
11,85MM FIX. 10MM



10.29.009
2 TERM. 6X6MM KNOB
11,85MM FIX. 13MM



10.29.010
2 TERM. 6X6MM KNOB 13MM
FLX 13MM



10.29.006
CHAVE TACTIL 6,0 X 6,0 KNOB
9,5MM 2T



10.29.008
CHAVE TACTIL 6,0 X 6,0 KNOB
11,0MM 2T



10.29.017
CHAVE DE TOQUE 90° 11MM



10.29.012
CHAVE TACTIL EVQQBH 095 4T



10.26.043
2 TERM. 90° 8,5 X 16
KNOB 10MM KPT1112
HPS2070VCR.88X CCE



10.29.013
4 TERM. 2 CHAVES EVQQBH
18S



10.29.015
90 GR 3,0X6,0X 4,3MM 2T 90
KFC A06 W1 9,5



10.29.024
CHAVE TACTIL 3,0 X 6,0 KNOB
5MM 90°



10.26.045
2 TERM. 90° 8 X 15 KNOB 5MM
SUPORTE 18MM KPT1122AR



10.26.010
2 TERM. 7,5X7,5MM KNOB
5MM



10.26.070
CHAVE TACTIL 6T. 6X6 180°



10.26.020
4 TERM. 7,5X7,5MM KNOB
5MM

Todos os nomes, logotipos de empresas e produtos citados neste catálogo são marcas registradas de suas respectivas corporações. A citação dos mesmos tem a única intenção de auxiliar nossos clientes na identificação de nossos produtos que são compatíveis com os originais.

10.26.031
 180 GR 12X12X 8,5MM 4T
 KFC A06

10.26.032
 180 GR 12X12X 9,5MM 4T
 KFC A06

10.26.033
 180 GR 12X12X12 MM 4T KFC
 A06

10.26.029
 180 GR 6X6X11,0MM 4T 180
 KFC A06

10.26.030
 180 GR 6X6X13,0MM 4T 180
 KFC A06

10.26.011
 4 TERM. 4,5 X 4,5 MM KNOB
 3,8MM

10.26.051
 SMD 4 TERM. 180° 5 X 5 KNOB
 3MM TMUE312GAB

10.26.014
 4 TERM. 6X6MM KNOB 4,3MM

10.26.082
 CHAVE TACTIL 6,0X6,0 KNOB
 4,3MM 5T

10.26.067
 CHAVE ALPS 3 TERM. 90°
 3406001146

10.26.016
 4 TERM. 6X6 MM KNOB 5MM

10.26.023
 4 TERM. 6X6MM KNOB 7MM

10.26.068
 4 TERM. 180° 6 X 6 KNOB 9MM

10.26.017
 4 TERM. 6X6MM KNOB 9,5MM

10.26.034
 CHAVE TOQUE 6,0 X 6,0 KNOB 15,0MM 4T

10.26.086
 CHAVE TOQUE 6,0 X 6,0 KNOB 18,0MM 4T

10.26.035
 CHAVE TOQUE 6,0 X 6,0 KNOB 19MM 4T

10.26.021
 4 TERM. 12X12MM KNOB 4,3 MM

10.26.022
 6 TERM. GANCHO P/ FAX

10.27.000
 2 TERM. 5X5MM KNOB 4,3MM

10.27.001
 2 TERMINAIS 5X5MM KNOB 5 MM

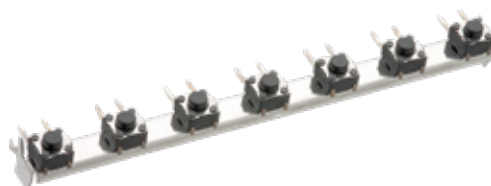
10.26.015
 4 TERM. 6X6MM KNOB 4,3MM

10.26.048
 2 TERM. 90° CONJUNTO COM 7 CHAVES + SUPORTE

10.26.046
 QUADRUPLA 19 X 19 KNOB 11MM DHT11064A1



10.26.060
SMD 4 TERM. 180° 4 X 3 KNOB 2.5MM
SKRPALE010



10.26.058
SMD 2 TERM. 90° 4.5 X 2 KNOB 3,6MM
IT1198A



10.26.073
CHAVE TOQUE SMD 2X4 TABLETE



10.26.074
CHAVE TOQUE SMD 3X63,5 P/ TABLETE



10.26.056
SMD 2 TERM. 180° 6 X 3.5 KNOB 4MM
204TS063543R 900



10.26.057
SMD 2 TERM. 180° 6 X 3.5 KNOB 4MM
STM241JN



10.26.061
SMD 4 TERM. 180° 4.5 X 4.5
KNOB 0,5MM SKRPABE010



10.26.064
SMD 4 TERM. 180° 3.7 X 3.7 KNOB
0.35MM



10.26.079
CHAVE SMD 2 TERMINAIS 90°



10.26.078
CHAVE MINI 4 TERMINAIS C/ ALAVANCA
PLASTICA



10.26.069
SMD 4 TERM. 180° 6 X 6 KNOB 2MM



10.26.049
SMD 4 TERM. 180° 6.2 X 6.2 KNOB 3MM
JTP1169BEM 12V/50MA



10.26.053
SMD 4 TERM. 180° 4.5 X 4.5 KNOB 1.5MM JTP-
1127WEM 12V/50MA



10.26.003
2 TERM. 3 X6 KNOB 5MM



10.26.044
2 TERM. BRANCA 6 X 3 KNOB 5MM



10.26.005
2 TERM. 3,5X6X2,5MM SMD

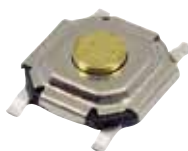

10.26.012
4 TERM. 5,2 X 5,2 MM KNOB 1,6MM



10.26.052
SMD 4 TERM. 180° 6 X 6 X KNOB 5MM JTP1138A6EM



10.26.013
4 TERM. 6X6MM KNOB 3,1MM



10.26.071
CHAVE TACTIL 6T SMD



10.26.055
SMD 6 TERM. 180° 5 X 5 KNOB 2MM
C/ 2 LED LS6J2M1DT

Todos os nomes, logotipos de empresas e produtos citados neste catálogo são marcas registradas de suas respectivas corporações. A citação dos mesmos tem a única intenção de auxiliar nossos clientes na identificação de nossos produtos que são compatíveis com os originais.



KNOB QUADRADO 2T DS 429 C/ TRAVA
 10.20.006 - PT 10.20.008 - VD
 10.20.007 - RX 10.20.009 - VM



KNOB QUADRADO 2T DS 431 S/ TRAVA
 10.20.016 - PT
 10.20.017 - VD
 10.20.018 - VM



KNOB QUADRADO 2T DS 460 C/ TRAVA
 10.20.010 - PT
 10.20.011 - VD
 10.20.012 - VM



KNOB QUADRADO 2T DS 461 S/ TRAVA
 10.20.019 - PT
 10.20.020 - VD
 10.20.021 - VM



KNOB QUADRADO 2T PBS 12A C/ TRAVA
 10.20.013 - PT
 10.20.014 - VD
 10.20.015 - VM



KNOB QUADRADO 2T PBS 12B S/ TRAVA
 10.20.022 - PT
 10.20.023 - VD
 10.20.024 - VM



KNOB REDONDO 2T DS 211 C/ TRAVA
 10.20.025 - PT
 10.20.026 - VD
 10.20.027 - VM



KNOB REDONDO 2T S/TRAVA DS 314
 10.20.046 - VM
 10.20.047 - PT
 10.20.048 - VD



KNOB REDONDO 2T S/ TRAVA DS 316
 10.20.028 - PT
 10.20.029 - VD
 10.20.030 - VM



KNOB REDONDO 2T DS 451 S/ TRAVA
 10.20.053 - VM
 10.20.054 - PT
 10.20.055 - VD



10.20.033
 CHAVE P.BOTTON 2T VERMELHA
 DS-450 C/ TRAVA



KNOB REDONDO 2T PBS 11A C/ TRAVA
 10.20.034 - PT
 10.20.035 - VD
 10.20.036 - VM



KNOB REDONDO 2T PBS 11B S/ TRAVA
 10.20.037 - PT
 10.20.038 - VD
 10.20.039 - VM



KNOB REDONDO 2T PBS 16A C/ TRAVA
 10.20.040 - PT
 10.20.041 - VD
 10.20.042 - VM



KNOB REDONDO 2T PBS 16B S/ TRAVA
 10.20.056 - PT
 10.20.057 - VM
 10.20.058 - VD



KNOB REDONDO 2T R13 502 S/ TRAVA
 10.20.064 - VM
 10.20.065 - PT
 10.20.066 - VD



KNOB REDONDO 2T R13 507 S/ TRAVA
 10.20.067 - PT
 10.20.068 - VD



10.20.073
 KNOB REDONDO 2T VD



KNOB REDONDO
 3T DS 612
 10.20.002 - VM
 10.20.003 - PT
 10.20.004 - VD



KNOB REDONDO NA 2T DS 323
 10.20.049 - AM 10.20.051 - VD
 10.20.050 - PT 10.20.052 - VM



KNOB REDONDO NA 2T PSB 110
 10.20.043 - PT
 10.20.044 - VD
 10.20.045 - VM



P MICRO SWITCH PBS 29
 10.20.059 - AM 10.20.062 - VD
 10.20.060 - AZ 10.20.063 - VM
 10.20.061 - PT



10.16.010
 ON/OFF BIPOLAR PHILIPS PT



10.16.011
CHAVE L/D PHILIPS PT (LINHA NOVA)



10.16.007
ON/OFF BIPOLAR P/ TV'S



10.16.016
CHAVE POWER



10.16.015
CHAVE L/D KDC-A04-2 5A/80A/250V 4T. C/ TRAVA



10.25.004
ON/OFF SEMP TOSHIBA / LG / SONY

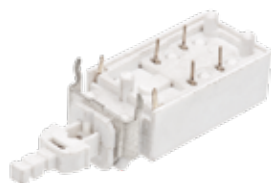

10.16.014
POWER 5A 120V / 10A 250V
KDC A14 1 C/ TRAVA



10.25.018
CHAVE LIGA/DESLIGA 2 POSIÇÕES C/
TRAVA

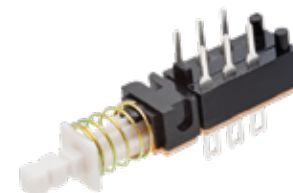

10.25.012
POWER P PCI S FIX KZJ 2X2 C/ TRAVA

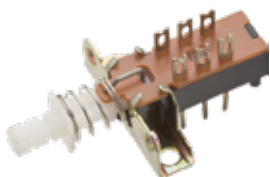

10.25.017
CHAVE LIGA/DESLIGA TV PARAGUAI



10.25.009
180GR 8,5X8,5MM C/ TRAVA



10.25.010
180GR 8,5X8,5MM S/ TRAVA



10.25.020
CHAVE TECLA 8X8 6T C/ TRAVA
C/ KNOB



SUB 1 PCI S FIX PS22 F05
10.25.005 - C/ TRAVA
10.25.006 - S/ TRAVA



10.25.019
CHAVE TECLA 3T C/ TRAVA KNOB



10.25.015
CHAVE TECLA 6T C/ TRAVA E KNOB
PRETO



10.25.013
CHAVE LIGA/DESLIGA C/TRAVA

Soquete para PCI Estampado

Contato em Ouro Torneado

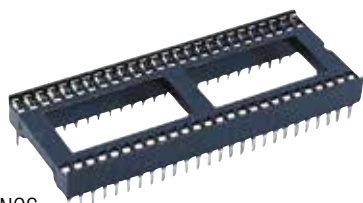

- 11.30.000 6 PINOS.....
- 11.30.001 8 PINOS.....
- 11.30.002 14 PINOS.....
- 11.30.003 16 PINOS.....
- 11.30.004 18 PINOS.....
- 11.30.005 20 PINOS.....
- 11.30.006 24 PINOS SLIN.....
- 11.30.007 28 PINOS.....
- 11.30.008 32 PINOS ESTREITO.....
- 11.30.009 32 PINOS LARGO.....
- 11.30.010 40 PINOS.....
- 11.30.011 DUPL0 52 PINOS.....



- 11.30.012 6 PINOS.....
- 11.30.013 8 PINOS.....
- 11.30.014 14 PINOS.....
- 11.30.015 16 PINOS.....
- 11.30.016 18 PINOS.....
- 11.30.017 20 PINOS.....
- 11.30.018 24 PINOS SLIN.....
- 11.30.019 32 PINOS.....
- 11.30.020 40 PINOS.....

Ilhada de Fibra

29.06.070 - 2 X12,9CM
 29.06.071 - 2,8 X12,9CM
 29.06.072 - 5 X10CM
 29.06.073 - 10 X10CM
 29.06.074 - 10 X15CM
 29.06.075 - 10 X20CM

29.06.076 - 10 X25CM
 29.06.077 - 10 X30CM
 29.06.078 - 15 X15CM
 29.06.079 - 15 X30CM
 29.06.080 - 20 X30CM

Fenolite Lisa Face Única

29.06.093 - 5X5
 29.06.094 - 5X10
 29.06.095 - 5X15
 29.06.096 - 5X20
 29.06.097 - 5X25
 29.06.098 - 5X30
 29.06.099 - 10X10

29.06.100 - 10X15
 29.06.101 - 10X20
 29.06.102 - 10X25
 29.06.103 - 10X30
 29.06.104 - 15X15
 29.06.105 - 15X20
 29.06.106 - 15X25

29.06.107 - 15X30
 29.06.108 - 20X20
 29.06.109 - 20X25
 29.06.110 - 20X30
 29.06.111 - 30X30

Fenolite Lisa Dupla Face

29.06.112 - 5X5
 29.06.113 - 5X10
 29.06.114 - 5X15
 29.06.115 - 5X20
 29.06.116 - 10X10
 29.06.117 - 10X15
 29.06.118 - 10X20

29.06.119 - 10X25
 29.06.120 - 10X30
 29.06.121 - 15X15
 29.06.122 - 15X20
 29.06.123 - 15X25
 29.06.124 - 15X30
 29.06.125 - 20X20

29.06.126 - 20X25
 29.06.127 - 20X30
 29.06.128 - 25X25
 29.06.129 - 25X30
 29.06.130 - 30X30

Fibra Simples

29.06.131 - 5X5
 29.06.132 - 5X10
 29.06.133 - 5X15
 29.06.134 - 5X20
 29.06.135 - 10X10
 29.06.136 - 10X15
 29.06.137 - 10X20

29.06.138 - 10X25
 29.06.139 - 10X30
 29.06.140 - 15X15
 29.06.141 - 15X20
 29.06.142 - 15X25
 29.06.143 - 15X30
 29.06.144 - 20X20

29.06.145 - 20X25
 29.06.146 - 20X30
 29.06.147 - 25X25
 29.06.148 - 25X30
 29.06.149 - 30X30

Fibra Dupla

29.06.150 - 5X5
 29.06.151 - 5X10
 29.06.152 - 5X15
 29.06.153 - 5X20
 29.06.154 - 10X10
 29.06.155 - 10X15
 29.06.156 - 10X20

29.06.157 - 10X25
 29.06.158 - 10X30
 29.06.159 - 15X15
 29.06.160 - 15X20
 29.06.161 - 15X25
 29.06.162 - 15X30
 29.06.163 - 20X20

29.06.164 - 20X25
 29.06.165 - 20X30
 29.06.166 - 25X25
 29.06.167 - 25X30
 29.06.168 - 30X30

Barra de Terminais

BARRA DE TERMINAIS
 29.00.004 - 20T 2 X 1T X 6

Todos os nomes, logotipos de empresas e produtos citados neste catálogo são marcas registradas de suas respectivas corporações. A citação dos mesmos tem a única intenção de auxiliar nossos clientes na identificação de nossos produtos que são compatíveis com os originais.



29.06.064
840PTS BB 01



29.06.068 - 1680PTS BB 2T4D 01



29.06.069 - 3260 PTS BB 02T 7D 01
0309 15



CANETA P/ CIRCUITO IMPRESSO
29.06.057 - PRETO
29.06.177 - VERMELHO
29.06.178 - AZUL

29.06.065 - 1360PTS BB 2T1D 01

29.06.171 - EPB0056 1280P 4X100
29.06.173 - EPB0058 2560P 7X100



29.06.196 - AZUL
CANETA PERMANENTE SCA-400 PONTA
4MM CHANFRADA



29.06.197 - PRETA
CANETA PERMANENTE SCA-400 PONTA
4MM CHANFRADA



29.06.198 - AZUL
CANETA PERMANENTE SCA-100 PONTA
4MM REDONDA



29.06.199 - PRETA
CANETA PERMANENTE SCA-100 PONTA
4MM REDONDA



29.06.200 - AZUL
CANETA MARCADOR V SUPER COLOR



29.06.201 - PRETA
CANETA MARCADOR V SUPER COLOR



29.06.202 - AZUL
REFIL V SUPER COLOR SCAS-VSC



29.06.203 - PRETA
REFIL V SUPER COLOR SCAS-VSC

29.06.058
KIT CONFEÇÃO
PCI CK 3



29.06.059
KIT CONFEÇÃO
PCI CK 10



29.06.060
KIT CONFEÇÃO
PCI CK 11



29.06.061
KIT CONFEÇÃO
PCI CK 15



29.06.062
KIT PERFURADOR
DE PCI KP 1



Todos os nomes, logotipos de empresas e produtos citados neste catálogo são marcas registradas de suas respectivas corporações. A citação dos mesmos tem a única intenção de auxiliar nossos clientes na identificação de nossos produtos que são compatíveis com os originais.



12.11.000
ACENDEDOR DE CIGARROS



12.11.001
PLUG ACENDEDOR CIGARRO C/LED



12.11.004
PLUG FÊMEA DE ACENDEDOR DE CIGARRO



12.02.004
BALOON AÉREO RSEE105



12.02.001
BALOON AÉREO VHF/UHF 75/300R



12.04.001
BALOON CACHIMBO 300W (MIN. 10 PÇS)



12.04.002
BALOON CACHIMBO 75/300W IMPORTADO (MIN. 20 PÇS)



12.04.000
CACHIMBO ENTR 300R



12.04.003
CACHIMBO ENTR 75/300R



12.10.005
MISTURADOR/SEPARADOR VHF/UHF 75/300R C/ROSCA



12.12.186
ADAPTADOR BORNE C/ TRAVA + J4
R\$ **1,95**



12.12.187
ADAPTADO BORNE C/ TRAVA + PLUG P4
R\$ **1,69**



12.12.188
ADAPTADOR BORNE C/ TRAVA + PLUG RCA
R\$ **1,95**



12.12.085
ADAPTADOR BORNE + BNC FÊMEA



12.12.090
ADAPTADOR BORNE + BNC MACHO



12.12.086
ADAPTADOR BORNE + P4 FÊMEA



12.12.087
ADAPTADOR BORNE + P4 MACHO



12.12.103
ADAPTADOR BORNE + RCA MACHO

Borne

- 15AMP 250V BO 058 (12X17MM)
- 12.03.002 - AM
- 12.03.003 - AZ
- 12.03.004 - BR
- 12.03.005 - PT
- 12.03.006 - VD
- 12.03.007 - VM



- 15AMP 250V BO 508 (12X17MM)
- 12.03.008 - AML
- 12.03.009 - AZ
- 12.03.010 - BR
- 12.03.011 - PT
- 12.03.012 - VD
- 12.03.013 - VM



MÚLTIPLO 10 Pcs



12.06.006
CONECTOR DB 09 FÊMEA P/SOLDA

MÚLTIPLO 10 Pcs



12.06.013
CONECTOR DB 09 MACHO

MÚLTIPLO 10 Pcs



12.06.039
CONECTOR DB9 MACHO 90° C/PORCA

MÚLTIPLO 10 Pcs



12.06.007
CONECTOR P/ SOLDA HDB15 FÊMEA

MÚLTIPLO 10 Pcs



12.06.038
CONECTOR HDB15 FÊMEA C/PARAFUSO

MÚLTIPLO 5 Pcs



12.06.021
CONECTOR HDB15 FÊMEA PLACA AZUL

MÚLTIPLO 5 Pcs



12.06.041
CONECTOR HDB15 FÊMEA PLACA

MÚLTIPLO 5 Pcs



12.06.027
CONECTOR DB15 FÊMEA 90° P/ PCI

MÚLTIPLO 10 Pcs



12.06.036
CONECTOR HDB15 FÊMEA P/ PAINEL

MÚLTIPLO 10 Pcs



12.06.008
CONECTOR P/ SOLDA HDB15 MACHO

MÚLTIPLO 5 Pcs



12.06.015
EMENDA HD 15 F + HD 15 M

MÚLTIPLO 5 Pcs



12.06.014
EMENDA HD 15 F + HD 15 F

MÚLTIPLO 5 Pcs



12.16.006
EMENDA DB9 FÊMEA + DB9 FÊMEA

NOVO



12.06.042
CONECTOR MINI HDMI FÊMEA PLACA

MÚLTIPLO 10 Pcs



12.06.022
CONECTOR HDMI P/ PLACA DE TV C/ SUPORTE

MÚLTIPLO 10 Pcs



12.06.037
CONECTOR HDMI P/PLACA C/ SUPORTE (A)

MÚLTIPLO 10 Pcs



12.06.032
CONECTOR HDMI FÊMEA C/ SUPORTE 4T.

MÚLTIPLO 10 Pcs



12.06.033
CONECTOR HDMI FÊMEA FIXAÇÃO LARGA

MÚLTIPLO 10 Pcs



12.06.034
CONECTOR HDMI FÊMEA FIXAÇÃO ESTREITA

MÚLTIPLO 10 Pcs



12.06.035
CONECTOR HDMI FÊMEA AMARELO

MÚLTIPLO 10 Pcs



12.06.023
CONECTOR HDMI FÊMEA P/PLACA TV LCD ABA SUPERIOR

MÚLTIPLO 10 Pcs



12.06.024
CONECTOR HDMI FÊMEA P/ PLACA TV LCD

MÚLTIPLO 10 Pcs



12.06.025
CONECTOR HDMI FÊMEA P/ PLACA TV LCD

MÚLTIPLO 10 Pcs



12.06.026
CONECTOR HDMI FÊMEA P/ PLACA TV LCD

MÚLTIPLO 10 Pcs



12.06.016
CONECTOR DB25 MACHO PCI 90°

MÚLTIPLO 10 Pcs



12.06.017
CONECTOR DB25 FÊMEA PCI 90°

MÚLTIPLO 10 Pcs



CONECTOR DB25 PCI 180°
12.06.018 - MACHO
12.06.019 - FÊMEA

MÚLTIPLO 10 Pcs



12.06.040
CONECTOR GT SOLDA PLACA 90°

Todos os nomes, logotipos de empresas e produtos citados neste catálogo são marcas registradas de suas respectivas corporações. A citação dos mesmos tem a única intenção de auxiliar nossos clientes na identificação de nossos produtos que são compatíveis com os originais.



12.07.047
CHAVE MULTIUSUARIO 6 DB



12.07.048
CHAVE MULTIUSUARIO 10 DB



12.07.049
CHAVE MULTIUSUARIO 20 DB



12.07.051
CHAVE DIPLEXER TV/INTERNET



DIVISOR SPLITER 5 A 900 MHZ

- 12.07.000 1 X 2 SAÍDAS.....
- 12.07.006 1 X 3 SAÍDAS.....
- 12.07.007 1 X 4 SAÍDAS.....



12.07.044
DIVISOR DE SINAL
1 X 2 SAÍDAS 5 A 1500 MHZ



12.07.009
DIVISOR SPLITER 900 A 2500 MHZ
1 X 2 SAÍDAS GC



12.07.040
DIVISOR DE SINAL
1 X 2 SAÍDAS 40 A 2050 MHZ



12.07.012
DIVISOR SPLITER 900 A 2500 MHZ
1 X 4 SAÍDAS GC



12.07.030
CHAVE DISEQ 4X1 950-2400MHZ



12.07.035
TAPE TIPO T 5 A 600 MHZ



12.07.036
TAPE TIPO T 5 A 900 MHZ



12.07.025
TAP TIPO T 1GHZ PHENOM 24DB

TAP Tipo T 1GHZ Phenom



- 12.07.020 - 06DB
- 12.07.021 - 09DB
- 12.07.022 - 12DB
- 12.07.023 - 16DB
- 12.07.024 - 20DB
- 12.07.026 - 27DB

CAIXA INJETADA EM ZAMAK E TRATAMENTO SUPERFICIAL;
TODAS AS PORTAS PARA CONEXÃO DO TIPO F - 75 OHMS;
SOLDER BACK. BOA RESISTÊNCIA A INTEMPÉRIES. LEVE E DE
TAMANHO COMPACTO

LEIA NA PÁGINA 1 DO
CATÁLOGO SOBRE NOSSA
POLÍTICA DE VENDA,
TROCA E GARANTIA



Phenom 5-1000Mhz.



12.07.014 - 2 SAÍDAS



12.07.015 - 3 SAÍDAS



12.07.017 - 4 SAÍDAS



12.07.018 - 6 SAÍDAS



12.07.019 - 8 SAÍDAS



12.08.024
EMENDA T



12.08.001
F FÊMEA P/
PAINEL



12.12.003
F MACHO P/ RCA FÊMEA



F P CRIMPAR C/ ANEL (EMB. 10 PÇS)
12.08.018 - RG 59
12.08.015 - RG 6



12.12.022
RCA MACHO P/ F FÊMEA



12.08.000
EMENDA F OU
RG58/50, RG59/75



12.08.016
F C ROSCA RG 59



12.08.019
F C ROSCA RG 6



12.08.032
F COMPRESSÃO RG6



12.08.017
CONECTOR F P/ CRIMPAR RG 59
TIPO BARRIL RSE-J02A



12.08.056
CONECTOR F C/ COMPRESSÃO
RG59 PRETO



12.08.058
CONECTOR F C /COMPRESSÃO
RG59 AZUL



12.08.059
CONECTOR F C/ COMPRESSÃO
RG6 CURTO AMARELO



12.08.057
CONECTOR F COMPRESSÃO
RG6 PRETO



12.08.023
F EMENDA MACHO 1+1
PLUG F RSEJ09



12.12.060
F X JACK F
NÍQUEL ST-FF001



12.12.029
PLUG ADAPT EUROPEU
MACHO X JACK F FÊMEA



12.12.004
PLUG ADAPTADOR
MACHO MINI DIN P RCA



12.12.007
P1 STÉREO X J 2 STÉREO IPOD



12.12.050
PLUG ADAPTADOR
P2 ST X J 2 ST PT-1500

Todos os nomes, logotipos de empresas e produtos citados neste catálogo são marcas registradas de suas respectivas corporações. A citação dos mesmos tem a única intenção de auxiliar nossos clientes na identificação de nossos produtos que são compatíveis com os originais.



12.12.044
PLUG ADAPT P2 ST X J10 ST



12.12.046
P 2 ST X 2JACK J 2 ST TP6902



12.12.049
PLUG ADAPTADOR
P2 ST X 2RCA TP6910



12.12.075
PLUG ADAPT P2 MONO X 2 JACK RCA



12.12.037
PLUG ADAPTADOR P10
MONO X JACK J 2 MONO PT1062



12.12.035
PLUG ADAPTADOR P10
MONO X JACK RCA



12.12.069
PLUG ADAPTADOR
P10 MONO X 2JACK RCA



12.12.036
PLUG ADAPTADOR
P10 ST X JACK J 2 ST PT1063



12.12.192
PLUG ADAPT.
P-10 ST X JACK J-2 ST METÁLICO



12.12.104
PLUG ADAPT P10M + RCA FÊMEA
METAL NÍQUEL



12.12.047
RCA MACHO X 2RCA FÊMEA PT1083



12.09.009
CANON FÊMEA CROMADO 1019



12.09.012
CANON FÊMEA PROFISSIONAL 1/2
CORPO PLÁSTICO X1001-PO



12.09.010
CANON JACK FÊMEA P/
PAINEL 1031



12.09.011
CANON JACK MACHO P/
PAINEL 1032



12.09.043
FÊMEA PAINEL PLÁSTICO
3 VIAS 90°



12.09.030
CANON JACK MACHO PAINEL PLÁSTICO
3 VIAS



12.09.019
CANON MACHO CROMADO 1020



12.09.013
CANON MACHO PROFISSIONAL
1/2 CORPO PLÁSTICO X1002-PO



CANON FÊMEA YS1057A
12.09.018 - AZ
12.09.006 - PT
12.09.007 - VM



CANON MACHO
YS1058A
12.09.005 - AZ
12.09.004 - VM
12.09.017 - PT



12.12.039
ADAPTADOR BNC X JACK RCA
JR6041/RSEJ23



12.12.000
BNC 75W P/ F FÊMEA C/ ROSCA
JR 6047 (MIN. 10 PÇS)



12.12.027
BNC PINO FIXO C/ PARAFUSO



12.12.179
BNC 4MM C/ MOLA E PARAFUSO



12.12.026
BNC PINO FIXO SOLDADA



12.12.025
BNC MACHO
P/ CLIMPAR - RG6



12.12.071
PLUG CONECTOR
BNC P/ SOLDA 90GR
HBN 125



12.12.070
CONECTOR BNC
PINO FIXO CAPA
PLÁSTICA



12.14.008
CONECTOR BNC RG6
PINO FIXO CLIMPAR



12.20.000
PLUG CONECTOR MIKE MACHO/FÊMEA
2 VIAS LS 3001/3008



12.20.001
PLUG CONECTOR MIKE MACHO/FÊMEA
3 VIAS LS 3002/3009



12.20.002
PLUG CONECTOR MIKE MACHO/FÊMEA
4 VIAS LS 3003/3010



12.20.003
PLUG CONECTOR MIKE MACHO/FÊMEA
5 VIAS LS 3004/3011



12.20.004
PLUG CONECTOR MIKE MACHO/FÊMEA
6 VIAS LS 3005/3012



12.20.005
PLUG CONECTOR MIKE MACHO/FÊMEA
7 VIAS LS 3006/3013



12.20.006
PLUG CONECTOR MIKE MACHO/FÊMEA
8 VIAS LS 3007/3014

Plugs



12.17.031
P2 MONO



12.17.005
P2 ST PLAST.



12.17.029
P2 ST METÁLICO
NÍQUELADO C/ MOLA
3,5MM TP1816



12.17.030
P2 ST MET. GOLD
WM 5007

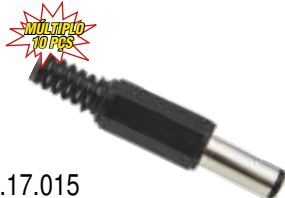

12.17.015
PLUG P4 2,1 X 5,5 X 14,00MM



12.17.047
PLUG P4 2,1MM CURTO



12.17.060
PLUG P4 DC 0,7 X 2,5MM

Todos os nomes, logotipos de empresas e produtos citados neste catálogo são marcas registradas de suas respectivas corporações. A citação dos mesmos tem a única intenção de auxiliar nossos clientes na identificação de nossos produtos que são compatíveis com os originais.

12.17.057
P4 DC 1.0 X 3.8 X 9.0MM



12.17.010
P8 5.5X2,5MM



12.17.036
P 10 MONO CORPO METAL
NIQUELADO 6,35MM



12.17.042
P 10 MONO CORPO
METAL NIQUELADO
PONTA GOLD 6,35MM P10-M



12.17.034
P 10 MONO CORPO METAL
PONTA GOLD AZ 6,35MM XC0198



12.17.033
P 10 MONO CORPO METAL
PONTA GOLD PT 6,35MM XC0198



12.17.032
P 10 MONO CORPO METAL
PONTA GOLD VM 6,35MM XC0195



12.18.027
P10 6.35MM MONO
NIQUELADO C/ MOLA



12.17.043
P 10 MONO CORPO PLÁSTICO
NIQUELADO 1/2 CORPO X5001-PO
6,35MM



12.17.048
PLUG P10 MONO METÁLICO
C/ PONTA DOURADA



12.17.035
P 10 MONO CORPO BAQUEL
PT 6,35MM TP 2801



12.17.044
P 10 MONO CORPO
PLÁSTICO NIQUELADO
6,35MM TP2802A/PT1005G - PT



12.17.068
PLUG P10ST METAL
PONTA DOURADA
TIPO NEUTRICK



12.17.067
PLUG P 10 MONO
CORPO METAL PONTA
GOLD AMARELO



12.17.039
P 10 ST CORPO METAL
DOURADO C/ MOLA
6,35MM PT 1015GD



12.17.038
P 10 ST CORPO METAL
NIQUELADO C/ MOLA
6,35MM PT 1015JR



12.17.040
P 10 MONO CORPO METAL NIQUELADO
90° CACHIMBO 10087



PLUG RCA PROFESSIONAL 6MM
ESTRIADO, DOURADA
12.18.021 - AMARELO
12.18.024 - VERDE
12.18.025 - VERMELHO



NOVO
PLUG RCA NÍQUEL PONTA DOURADA
12.18.042 - PRETO
12.18.043 - VERMELHO
12.18.044 - AZUL
12.18.045 - VERDE
12.18.046 - BRANCO

RCA MACHO METÁLICO
GOLD TP8808-R C/MOLA FIO 5/8MM
12.18.010 - VERMELHO
12.18.011 - PRETO



RCA MACHO METÁLICO
GOLD TP8810-R C/MOLA PT FIO 6/7MM
12.18.015 - VERMELHO
12.18.016 - PRETO





PLUG RCA FEMÊA DOURADO
12.18.040 - PRETO
12.18.041 - VERMELHO



PLUG RCA MACHO METÁLICO
NIQUEL RAC0116 C/MOLA PT
12.18.013 - VERMELHO
12.18.014 - PRETO



PLUG RCA MACHO PLÁSTICO
NIQUELADO PT-1096
12.18.012 - PT
12.18.017 - VM



PLUG RCA PLÁSTICO PRETO
12.18.038 - PRETO
12.18.039 - VERMELHO



12.19.002
PLUG SPEAKON MACHO PAINEL PLÁSTICO
2/4 PINOS AZ LS 5017 1



12.19.003
PLUG SPEAKON MACHO PAINEL PLÁSTICO
2/4 PINOS AZ LS 5017 2



12.19.005
PLUG SPEAKON MACHO 2/4 PINOS
PLÁSTICO LARANJA

Jacks



JACK J2
12.09.033 - PRETO
12.09.035 - VERDE
12.09.038 - BRANCO



12.09.047
JACK J2 MONO 3T PAINEL C/
ROSCA



12.09.032
JACK J2 STEREO 5T C/ ROSCA



12.09.048
JACK J2 STEREO 5T S/ ROSCA



12.09.053
JACK J2 STEREO



12.09.055
JACK J2 STEREO MINI (1)



12.09.056
JACK J2 STEREO MINI (2)



12.09.051
JACK J2 STEREO MINI



12.09.057
JACK J2 STEREO MINI (3)



12.09.061
JACK J2 STEREO P/ PLACA (A)



12.09.062
JACK J2 STEREO
P/ PLACA (B)



12.09.063
JACK J2 STEREO
P/ PLACA 90°



12.09.058
JACK J2 STEREO VERDE



12.09.052
JACK J2 STEREO
BLINDADO P/ PLACA



12.08.080
JACK J-2 STEREO



12.08.081
JACK J-2 STEREO



12.08.082
JACK J-4



12.08.083
JACK J-2 STEREO AMARELO



12.08.022
JACK J4 P PLACA 2,1 X 5,5MM
TP3836

Todos os nomes, logotipos de empresas e produtos citados neste catálogo são marcas registradas de suas respectivas corporações. A citação dos mesmos tem a única intenção de auxiliar nossos clientes na identificação de nossos produtos que são compatíveis com os originais.



12.08.031
JACK J4 P/PAINEL
2.1X5.5MM



12.08.050
JACK J-4 P/ PAINEL 2,5 X
5,5MM



12.08.077
JACK J-4 P/ PAINEL 2,5 X
5,5MM



12.09.039
JACK J10 STEREO C/ROSCA NA



12.09.040
JACK J10 MONO 5T NF



12.09.041
JACK J10 MONO 4T



12.09.042
JACK J10 STEREO 6T PLACA



12.09.044
JACK J10 STEREO 6T



12.09.046
JACK J10 STEREO 6T PLACA
E FURO



12.12.178
JACK P/ TELEFONE 6PX2C P/
PLACA



12.12.042
EMENDA RCA FÊMEA SIMPLES PT1444



12.12.034
EMENDA RCA FÊMEA DUPLA



12.12.067
EMENDA RCA FÊMEA TRIPLA



12.03.020
BORNE RCA 1 TOMADA BRANCO



12.03.045
BORNE RCA SIMPLES PRETO



JACK RCA P PAINEL
12.08.027 - PRETO
12.08.028 - VERMELHO



12.03.026
BORNE RCA
2 TOMADAS
AMARELO E BRANCO



12.03.040
BORNE RCA 3 TOMADAS AM.BCO.VM.
BASE AMARELA



12.03.041
BORNE RCA 3 TOMADAS AM.BCO.VM.
BASE PRETA



12.03.027
BORNE RCA 3 TOMADAS VERMELHO
AZUL VERDE



12.03.039
BORNE RCA 3 TOMADAS VIDEO
COMPONENTE VM-AZL-VD DOURADO

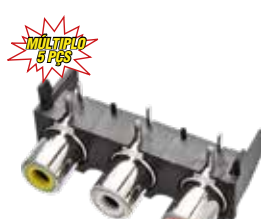

12.03.043
BORNE RCA 3 TOMADAS VM-BCO-AM

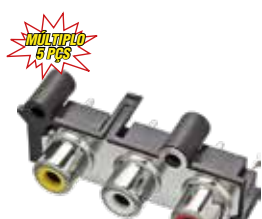

12.03.050
BORNE RCA 3 TOMADAS AM-BCO-VM



12.03.030
BORNE RCA 3 TOMADAS
AM-BCO-VERM. + SVHS + J2ST.



12.03.019
BORNE RCA
4 TOMADAS
VM/BCO.



12.03.031
BORNE RCA 4 TOMADAS
AMARELO - BRANCO

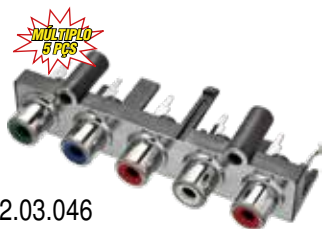

MÚTIPLA 5 Pcs
12.03.046
BORNE RCA 5 TOMADAS
AV / VIDEO COMPONENTE



MÚTIPLA 5 Pcs
12.03.048
BORNE RCA 5 TOMADAS
VD-AZ-VM-BCO



MÚTIPLA 5 Pcs
12.03.033
BORNE RCA 6 TOMADAS
VM-BCO.-AMR\$



MÚTIPLA 5 Pcs
12.03.034
BORNE RCA 6 TOMADAS
BCO.VERDE.AZUL.VM.AM



MÚTIPLA 5 Pcs
12.03.035
BORNE RCA 6 TOMADAS
BCO, VD, VM, AZUL, PRETO VERTICAL



MÚTIPLA 5 Pcs
12.03.053
BORNE RCA 6 TOMADAS
VD-AZ-VM-AM-BCO



MÚTIPLA 5 Pcs
12.03.036
BORNE RCA 9 TOMADAS
AMARELA - BRANCO - VERMELHO



MÚTIPLA 5 Pcs
12.03.049
BORNE RCA 9 TOMADAS
VD-AZ-VM-BCO-AM-LJ

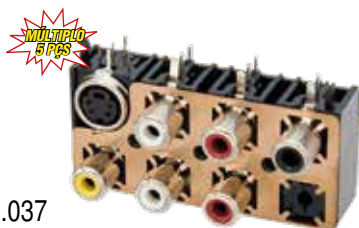

MÚTIPLA 5 Pcs
12.03.037
BORNE RCA 7 TOMADAS + SVHS PR/VM/
AZ/VD/AM



MÚTIPLA 5 Pcs
12.03.038
BORNE RCA 6 TOMADAS
VM.BCO.AM



MÚTIPLA 5 Pcs
12.03.018
BORNE RCA 6 TOMADAS
VM/BCO.



MÚTIPLA 5 Pcs
12.03.021
BORNE RCA 5 TOMADAS
AV/VIDEO COMPONENTE



MÚTIPLA 5 Pcs
12.03.023
BORNE RCA 3 TOMADAS
VERM/BCO/AMARELO SVHS



MÚTIPLA 10 Pcs
12.12.074
CONECTOR BNC FÊMEA P/PAINEL



MÚTIPLA 10 Pcs
12.12.172
CONECTOR USB FÊMEA
V3 MINI PINOS DOURADOS



MÚTIPLA 10 Pcs
12.12.105
CONECTOR USB A FÊMEA USB01B



MÚTIPLA 10 Pcs
12.12.106
CONECTOR USB A FÊMEA P/ PLACA



MÚTIPLA 10 Pcs
12.12.133
CONECTOR USB A FÊMEA VERTICAL
CURTO

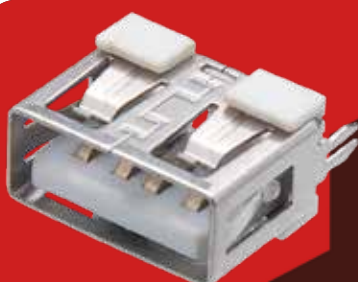

MÚTIPLA 10 Pcs
12.12.134
CONECTOR USB A FÊMEA



12.12.205
CONECTOR USB A
FÊMEA ISOLADOR
TRANSPARENTE

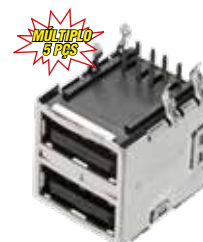

MÚTIPLA 5 Pcs
12.12.145
CONECTOR USB A
FÊMEA DUPLO

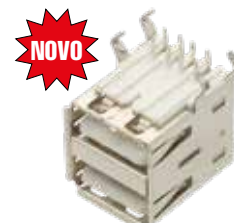

NOVO
12.12.107
CONECTOR USB A
FÊMEA DUPLO YH-USB
02

Todos os nomes, logotipos de empresas e produtos citados neste catálogo são marcas registradas de suas respectivas corporações. A citação dos mesmos tem a única intenção de auxiliar nossos clientes na identificação de nossos produtos que são compatíveis com os originais.

MULTIPLA
10 PÉS



12.12.147
CONECTOR USB A FÊMEA

MULTIPLA
10 PÉS



12.12.148
CONECTOR USB A FÊMEA
PRETO

NOVO



12.12.195
CONECTOR USB HT

MULTIPLA
10 PÉS



12.12.149
CONECTOR USB A FÊMEA
PLACA 23KLC

NOVO



12.12.193
CONECTOR USB

NOVO

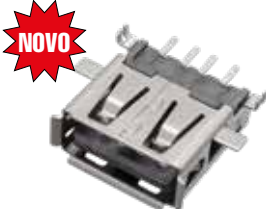

12.12.196
CONECTOR USB

MULTIPLA
10 PÉS



12.12.171
CONECTOR USB A FÊMEA
YHB01A

NOVO



12.12.199
CONECTOR USB

NOVO



12.12.200
CONECTOR USB

MULTIPLA
10 PÉS



12.12.175
CONECTOR USB FÊMEA D

MULTIPLA
10 PÉS



12.12.173
CONECTOR USB FÊMEA C

NOVO



12.12.197
CONECTOR USB

NOVO



12.12.198
CONECTOR USB

NOVO



12.12.203
CONECTOR USB FÊMEA

MULTIPLA
10 PÉS

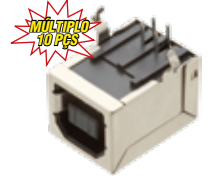

12.12.108
CONECTOR USB B FÊMEA P/
PLACA YH-USB03

MULTIPLA
10 PÉS



12.12.109
CONECTOR USB B MACHO P/
CABO USB04

MULTIPLA
10 PÉS



12.12.110
CONECTOR USB A MACHO P/
PLACA YH-USB05A

MULTIPLA
10 PÉS



12.12.111
CONECTOR USB A MACHO P/
PLACA 180° YH-USB05B

MULTIPLA
10 PÉS

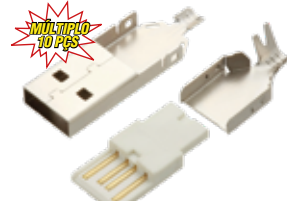

12.12.112
CONECTOR USB A
MACHO P/ CABO YH-USB06

MULTIPLA
5 PÉS



12.12.136
JACK P/REDE 8P8C RJ45
BLINDADO

MULTIPLA
10 PÉS



12.09.059
JACK MINI DIN 4 PINOS SVHS

MULTIPLA
10 PÉS



12.09.060
JACK MINI DIN 6 PINOS

MULTIPLA
10 PÉS



12.08.072
JACK OPTICO

MULTIPLA
5 PÉS



12.12.177
JACK 8P8 RJ 45 P/PLACA

NOVO



12.12.201
JACK 8P8 RJ45 PARA PLACA

NOVO



12.12.202
JACK 8P8 RJ45 PARA PLACA



12.12.204
JACK P/ REDE 8P8C BLINDADO
C/ LED

MULTIPLA
5 PÉS



12.12.137
JACK P/REDE DUPLO 8P8C
RJ45 BLINDADO

MULTIPLA
5 PÉS



12.12.153
CONECTOR USB MINI P/PLACA
7 PINOS SAMSUNG

MULTIPLA
10 PÉS



12.12.124
CONECTOR USB FÊMEA V3 =
MINI P/ CELULAR TABLET



12.12.125
CONECTOR USB FÊMEA V3 =
MINI P/ CELULAR TABLET



12.12.126
CONECTOR USB FÊMEA V3 = MINI P/
CELULAR TABLET



12.12.127
CONECTOR USB FÊMEA V8 = MICRO P/
CELULAR E TABLET



12.12.194
CONECTOR V8

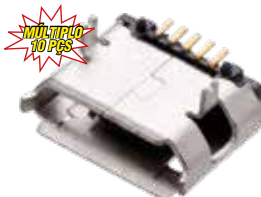

12.12.128
CONECTOR USB FÊMEA V8 = MICRO P/
CELULAR E TABLET



12.12.167
CONECTOR USB FÊMEA V8 = MICRO
C/ ASA



12.12.169
CONECTOR USB FÊMEA
V8 = MICRO SAMSUNG I9300



12.12.185
CONECTOR USB MACHO V8 COM CAPA

Câmara de Segurança e Acessórios

**OFERTA PARA
ZERAR
ESTOQUE**



24.03.006
CÂMERA CCD
FLY-785
C/ SUPORTE



24.03.008
CÂMERA CCD
FLY-786
C/ SUPORTE



12.12.154
VÍDEO BALLOON PASSIVO
PAR TRANÇADO 4 CANAIS



12.12.155
VÍDEO BALLOON PASSIVO
PAR TRANÇADO 8 CANAIS



38.17.000
CABO RF 4,00MM 2X26AWG
100M BRANCO EXTERNO



12.12.180
CONECTOR VÍDEO
BALLON PASSIVO
HD-CVI/TV - BLISTER C/ 2 PEÇAS



12.12.152
CONECTOR C/ CABO VÍDEO
BALLOON PASSIVO
BLISTER C/ 2 PEÇAS



12.12.132
CONECTOR VÍDEO
BALLOON PASSIVO
BLISTER C/ 2 PEÇAS



15.09.005
SENSOR RECEPTOR DE SINAL DE CONTROLE REMOTO



15.09.006
SENSOR RECEPTOR DE SINAL DE CONTROLE REMOTO



15.09.008
SENSOR RECEPTOR DE SINAL DE CONTROLE REMOTO



15.09.009
SENSOR RECEPTOR DE SINAL DE CONTROLE REMOTO TV LCD PHILIPS E OUTRAS



15.02.049
SENSOR EMISSOR DE SINAL DE CONTROLE REMOTO 5MM



30.00.013
SELETOR VARICAP TDQ6F/13F2S



30.00.014
SELETOR VARICAP 115 B 8135



30.00.016
SELETOR VARICAP UVE 50 AW73D



30.00.018
SELETOR VARICAP 6700NF NS 11F



30.00.019
SELETOR VARICAP BN40-00146B



30.00.020
SELETOR VARICAP BN40-00113A



30.00.007
SELETOR VARICAP SBF8010



30.00.008
SELETOR VARICAP TNH-0304R-3



30.00.010
SELETOR VARICAP TEDH8-601A



30.00.000
VARICAP SAMSUNG TBLU18120IN1T

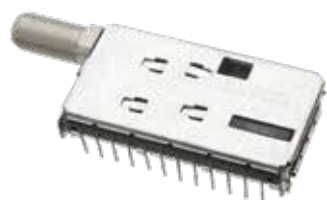

30.00.001
VARICAP D8655G P/LCD-LED



30.00.002
VARICAP BN40-00113A

Todos os nomes, logotipos de empresas e produtos citados neste catálogo são marcas registradas de suas respectivas corporações. A citação dos mesmos tem a única intenção de auxiliar nossos clientes na identificação de nossos produtos que são compatíveis com os originais.



24.16.028
PC REMOTE
CONTROLLER



AOC
13.78.001
LE42H057D



AOC
13.78.000
L42H83



AOC
13.78.002
M19W531



**OFERTA PARA
ZERAR
ESTOQUE**



**BRITÂNIA /
MATRIX**
13.07.002
PLUS



**OFERTA PARA
ZERAR
ESTOQUE**



BRITÂNIA
13.07.003
FAMA 2 - DVD



**OFERTA PARA
ZERAR
ESTOQUE**



BRITÂNIA
13.07.008
DVD FAMA 3



**OFERTA PARA
ZERAR
ESTOQUE**



BUSTER
13.80.000
HTR-D19



BUSTER
13.80.004
HTR-D19 ALL



CCE
13.10.043
RC 512 STILE
L2401 D3201



CCE
13.10.045
RC 503



CCE
13.10.046
RC 507 D32 D40
D42



Todos os nomes, logotipos de empresas e produtos citados neste catálogo são marcas registradas de suas respectivas corporações. A citação dos mesmos tem a única intenção de auxiliar nossos clientes na identificação de nossos produtos que são compatíveis com os originais.



CCE
13.10.048
RC507 ALL



**OFERTA PARA
ZERAR
ESTOQUE**



CCE
13.10.042
DVD



**OFERTA PARA
ZERAR
ESTOQUE**



CCE
13.10.030
DVD PLAYER



CCE /PHILIPS
13.10.007
HPS 14R



**OFERTA PARA
ZERAR
ESTOQUE**



CCE
13.10.050
1401/92 2001/92
0214B



**OFERTA PARA
ZERAR
ESTOQUE**



CCE /PHILIPS
13.10.020
HPS 1470



**OFERTA PARA
ZERAR
ESTOQUE**



CCE
13.10.004
HPS 1480



**OFERTA PARA
ZERAR
ESTOQUE**



CCE
13.10.006
HPS 1491



**OFERTA PARA
ZERAR
ESTOQUE**



CCE
13.10.023
HPS 2881



**OFERTA PARA
ZERAR
ESTOQUE**



CCE
13.10.018
HPS 2971



**OFERTA PARA
ZERAR
ESTOQUE**



CENTURY
13.11.004
SUPER
COLOR



**OFERTA PARA
ZERAR
ESTOQUE**



CENTURY
13.11.002
USR 1900 PRETO



**OFERTA PARA
ZERAR
ESTOQUE**

CENTURY
13.11.000
USR 1950



OFERTA PARA ZERAR ESTOQUE

CENTURY
13.11.003
USR1950



OFERTA PARA ZERAR ESTOQUE

CINERAL
13.12.000
TS2077



OFERTA PARA ZERAR ESTOQUE

CYBER
13.10.018
RC-201



OFERTA PARA ZERAR ESTOQUE

CYBERHOME
13.55.000
DVD CYBERHOME



OFERTA PARA ZERAR ESTOQUE

ELETRVISION
13.57.000



OFERTA PARA ZERAR ESTOQUE

ELSYS
13.58.002
RECEPTOR ELSYS DUOMAX



OFERTA PARA ZERAR ESTOQUE

ELSYS
13.58.003
RECEPTOR ELSYS BLACK



OFERTA PARA ZERAR ESTOQUE

ELSYS
13.58.000
ELDP 1500



OFERTA PARA ZERAR ESTOQUE

FRESAT
13.16.001
SRE 3000 C PLUS/
FRESAT SER
3000" A" PLUS /
PLB



OFERTA PARA ZERAR ESTOQUE

**GOLDSTAR/
LG**
13.22.012
CN 440



OFERTA PARA ZERAR ESTOQUE

GRADIENTE
13.17.011
DVD GRADIENTE



OFERTA PARA ZERAR ESTOQUE

Todos os nomes, logotipos de empresas e produtos citados neste catálogo são marcas registradas de suas respectivas corporações. A citação dos mesmos tem a única intenção de auxiliar nossos clientes na identificação de nossos produtos que são compatíveis com os originais.

GRADIENTE
13.17.006
DVD'S GRADIENTE
MOD. D10



OFERTA PARA ZERAR ESTOQUE

GRADIENTE
13.17.010
DVD
GRADIENTE
D-202





OFERTA PARA ZERAR ESTOQUE

GRADIENTE
13.17.022
SKY GSD100



OFERTA PARA ZERAR ESTOQUE

H-BUSTER
13.80.002
TV LCD



OFERTA PARA ZERAR ESTOQUE

LENOX
13.51.002
SOUND
BLACK



OFERTA PARA ZERAR ESTOQUE

LENOX
13.51.007
TV RC-701/TV-1400/TV-2100



OFERTA PARA ZERAR ESTOQUE

LG/SAMSUNG
13.22.046
COM FUNÇÕES
SMART,
3D,FUTEBOL



NOVO

LG
13.22.029
AKB36638215
- MCV904 -
MCS764F -MCD



OFERTA PARA ZERAR ESTOQUE

LG
13.22.031
AKB72914210
AKB72914221



OFERTA PARA ZERAR ESTOQUE

LG
13.22.042
AKB729194210-
221



OFERTA PARA ZERAR ESTOQUE

LG
13.22.032
AKB72914245



OFERTA PARA ZERAR ESTOQUE

LG
13.22.033
AKB73275616



OFERTA PARA ZERAR ESTOQUE



LG
13.22.039
AKB73715613



LG
13.22.034
MKJ30036809



**OFERTA PARA
ZERAR
ESTOQUE**



LG
13.22.035
AKB69680416



**OFERTA PARA
ZERAR
ESTOQUE**



LG
13.22.037
AKB73615319



LG
13.22.015
TV LG 6711R



**OFERTA PARA
ZERAR
ESTOQUE**



LG
13.22.004
TV 6710V 00090H



LG
13.22.013
6710900010S



**OFERTA PARA
ZERAR
ESTOQUE**



LG
13.22.018
MKJ32022805



**OFERTA PARA
ZERAR
ESTOQUE**



LG
13.22.021
MKJ32022840



LG
13.22.023
MKJ33981409



**OFERTA PARA
ZERAR
ESTOQUE**



LG
13.22.041
MKJ33981409



**OFERTA PARA
ZERAR
ESTOQUE**



LG
13.22.025
MKJ42613813



**OFERTA PARA
ZERAR
ESTOQUE**

Todos os nomes, logotipos de empresas e produtos citados neste catálogo são marcas registradas de suas respectivas corporações. A citação dos mesmos tem a única intenção de auxiliar nossos clientes na identificação de nossos produtos que são compatíveis com os originais.



LG
13.22.024
AKB7291521



DUOSAT
13.24.009
DUOSAT SPIDER
HD



**OFERTA PARA
ZERAR
ESTOQUE**



NET
13.24.001
NET 9800 / 9805



**OFERTA PARA
ZERAR
ESTOQUE**



OI
13.26.011
RECEPTOR OI TV
BLACK



**OFERTA PARA
ZERAR
ESTOQUE**



OI
13.26.009
TV HD



**OFERTA PARA
ZERAR
ESTOQUE**



ORBISAT
13.26.004
SATRON SS



**OFERTA PARA
ZERAR
ESTOQUE**



ORBISAT
13.26.005
SST 2100



**OFERTA PARA
ZERAR
ESTOQUE**



ORBISAT
13.26.006



**OFERTA PARA
ZERAR
ESTOQUE**



PANASONIC
13.27.034
LCD
N2QAYB000570



PANASONIC
13.27.027
VIERA TH-
42PV70BL

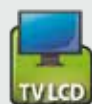

**OFERTA PARA
ZERAR
ESTOQUE**



PANASONIC
13.27.030
UNIVERSAL VIERA
N2QAYB000570



**OFERTA PARA
ZERAR
ESTOQUE**



PANASONIC
13.27.036
COM TECLA
NETFLIX





PHILCO
13.28.042
ORIGINAL
TODA LINHA TV
LCD



OFERTA PARA
**ZERAR
ESTOQUE**



PHILCO
13.28.035
PH32D PH32M



OFERTA PARA
**ZERAR
ESTOQUE**



PHILCO
13.28.031
PH2U5/
PH29U5 A2



OFERTA PARA
**ZERAR
ESTOQUE**



PHILCO
13.28.032
PH14D PH21C
PH29B



PHILCO
13.28.033
TCF2910 TPF 2941



OFERTA PARA
**ZERAR
ESTOQUE**



PHILCO
13.28.036
PH24M3/MR3



OFERTA PARA
**ZERAR
ESTOQUE**



PHILCO
13.28.037
PH24M



OFERTA PARA
**ZERAR
ESTOQUE**



PHILCO
13.28.038
PH32M



OFERTA PARA
**ZERAR
ESTOQUE**



PHILCO
13.28.043
TV LED
32D-42D-32M-42M



OFERTA PARA
**ZERAR
ESTOQUE**



PHILIPS
13.29.021
20PT 524



PHILIPS
13.29.055
29PT 4631



OFERTA PARA
**ZERAR
ESTOQUE**



PHILIPS
13.10.020
PCS 1310



Todos os nomes, logotipos de empresas e produtos citados neste catálogo são marcas registradas de suas respectivas corporações. A citação dos mesmos tem a única intenção de auxiliar nossos clientes na identificação de nossos produtos que são compatíveis com os originais.

PHILIPS
13.29.031



OFERTA PARA ZERAR ESTOQUE

PHILIPS
13.29.032



OFERTA PARA ZERAR ESTOQUE

PHILIPS
13.29.015
TRENDSET



OFERTA PARA ZERAR ESTOQUE

PHILIPS
13.29.078
PHILIPS LCD
32PFL5403-
42PFL5403



PHILIPS
13.29.079
PHILIPS LCD
42PFL7803D-
52PFL7803D



OFERTA PARA ZERAR ESTOQUE

PHILIPS
13.29.080
PHILIPS
RC2143608-01



PHILIPS
13.29.081
PHILIPS LCD
SERIE
3000



OFERTA PARA ZERAR ESTOQUE

PHILIPS
13.29.084
AMBILIGHT
32PFL5604D/78



PHILIPS
13.29.092
LD SMART
42PFL6007G



OFERTA PARA ZERAR ESTOQUE

PHILIPS
13.29.095
ORIGINAL



PHILIPS
13.29.091
TV SMART
ORIGINAL



PLASMATIC
13.04.001
RP 600



OFERTA PARA ZERAR ESTOQUE

PLASMATIC
13.04.002
RP 600 RP 610
SLIM



OFERTA PARA ZERAR ESTOQUE

PROVIEW
13.73.002
DVP 868



OFERTA PARA ZERAR ESTOQUE

PROVIEW
13.73.004
LCD



OFERTA PARA ZERAR ESTOQUE

PHILIPS/SKY
13.11.001
RECEPTORES DE "TV ASSINATURA"
SISTEMA UNIV. CODIFICADO
ATRAVÉS DE CODIFICAÇÃO
SERVE PARA TODOS DOS
MODELOS:
PHILIPS/CENTURY
GRADIENTE GSD
100/400/600/1000
1500



OFERTA PARA ZERAR ESTOQUE

SAMSUNG
13.32.033
LCD BN59-00888A



OFERTA PARA ZERAR ESTOQUE

SAMSUNG
13.32.028
BN59 00869A



OFERTA PARA ZERAR ESTOQUE

SAMSUNG
13.32.057
BN59-00869A



OFERTA PARA ZERAR ESTOQUE

SAMSUNG
13.32.029
BN59 01011A



OFERTA PARA ZERAR ESTOQUE

SAMSUNG
13.32.039
AH59-01907B



OFERTA PARA ZERAR ESTOQUE

SAMSUNG
13.32.040
AH59-02298 A



OFERTA PARA ZERAR ESTOQUE

SAMSUNG
13.32.054
BN59-01004A



OFERTA PARA ZERAR ESTOQUE

SAMSUNG
13.32.059
BN59-00866A



OFERTA PARA ZERAR ESTOQUE

Todos os nomes, logotipos de empresas e produtos citados neste catálogo são marcas registradas de suas respectivas corporações. A citação dos mesmos tem a única intenção de auxiliar nossos clientes na identificação de nossos produtos que são compatíveis com os originais.



SAMSUNG
13.32.044
BN59 00866A



SAMSUNG
13.32.049
LED AA59-00605A



SAMSUNG
13.32.050
AA59-00588A



SAMSUNG
13.32.025
AH59-02144M
HOME
THEATER



**OFERTA PARA
ZERAR
ESTOQUE**



SAMSUNG
13.32.060
NAH59D02144B



**OFERTA PARA
ZERAR
ESTOQUE**



SAMSUNG
13.32.022
BN59 00604A



**OFERTA PARA
ZERAR
ESTOQUE**



SAMSUNG
13.32.015
BN 59
LCD - 00690A

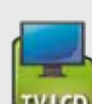

**OFERTA PARA
ZERAR
ESTOQUE**



SAMSUNG
13.32.056
BN59-00690A



**OFERTA PARA
ZERAR
ESTOQUE**



SAMSUNG
13.32.055
BN59-00490A



**OFERTA PARA
ZERAR
ESTOQUE**



SAMSUNG
13.32.017
BN59-00556A



**OFERTA PARA
ZERAR
ESTOQUE**



SAMSUNG
13.32.058
BN59-00556A



**OFERTA PARA
ZERAR
ESTOQUE**

SAMSUNG
13.32.022
BN59-00604A



OFERTA PARA ZERAR ESTOQUE

SAMSUNG
13.32.053
BN59-00429A



OFERTA PARA ZERAR ESTOQUE

SAMSUNG
13.32.031
LCD RM-D762A



OFERTA PARA ZERAR ESTOQUE

SEMP TOSHIBA
13.34.010
LED STI-CT 6390



OFERTA PARA ZERAR ESTOQUE

SEMP TOSHIBA
13.34.035
LCD



OFERTA PARA ZERAR ESTOQUE

SEMP TOSHIBA
13.34.004
LUMINA



OFERTA PARA ZERAR ESTOQUE

SEMP TOSHIBA
13.34.030
LCD CT-90333



OFERTA PARA ZERAR ESTOQUE

SEMP TOSHIBA
13.34.039
CT6340



OFERTA PARA ZERAR ESTOQUE

SEMP TOSHIBA
13.34.038
CT90336



OFERTA PARA ZERAR ESTOQUE

Todos os nomes, logotipos de empresas e produtos citados neste catálogo são marcas registradas de suas respectivas corporações. A citação dos mesmos tem a única intenção de auxiliar nossos clientes na identificação de nossos produtos que são compatíveis com os originais.

SHARP
13.35.016
LC32R24B



OFERTA PARA ZERAR ESTOQUE

SHARP
13.35.003
PIP 29 - TV'S
SHARP C/ PIP / FREEZE



OFERTA PARA ZERAR ESTOQUE

SKY
13.52.006
RC1643 ORIGINAL



SKY
13.52.007
RC65SB ORIGINAL



SKY
13.52.003
ORIGINAL RC645W



SKY
13.52.004
HDTV ORIGINAL



SONY
13.36.014
RM-YA006



OFERTA PARA ZERAR ESTOQUE

SONY
13.36.017
RM-YD023



SONY
13.36.022
RMYD023



OFERTA PARA ZERAR ESTOQUE



SONY

13.36.019
RM-YD047



SUPEX

13.41.001
ZPX-2300VA



OFERTA PARA
**ZERAR
ESTOQUE**



TECSAT

13.38.002
TRC-18



OFERTA PARA
**ZERAR
ESTOQUE**



UNIVERSAL

13.39.005
P/ 12 MARCAS
DE TV



OFERTA PARA
**ZERAR
ESTOQUE**



UNIVERSAL

13.39.011
TV LCD 175 MARCAS



OFERTA PARA
**ZERAR
ESTOQUE**



VISIONTEC

13.40.004
VT1000S CO 957



OFERTA PARA
**ZERAR
ESTOQUE**



VISIONTEC

13.40.006
VT 1000S PRATA AL



OFERTA PARA
**ZERAR
ESTOQUE**



VISIONTEC

13.40.001
VT 1000P



OFERTA PARA
**ZERAR
ESTOQUE**



13.81.000
NEO ZBT-650N RECEPTOR
DIGITAL



OFERTA PARA
**ZERAR
ESTOQUE**

UNIVERSAL

13.39.006
PARA AR CONDICIONADO
KT-1000

UNIVERSAL

13.39.010
AR CONDICIONADO KT
1000PLUS

LG

13.22.020
AR

Correias Micro System

CÓDIGO	DESCRIÇÃO
24.17.000	AIWA CX - NS 229 LH
24.17.001	AIWA CX - NS 707 LH
24.17.002	AIWA CX NF 969. NSX 590
24.17.003	AIWA CXN - 3550 U
24.17.004	AIWA CX-S 50
24.17.005	AIWA MICRO SYSTEM F9.F12.F15.F959
24.17.006	AIWA MICRO SYSTEM F9.F12.F15.F959 (5 CD 'S)
24.17.007	AIWA MICRO SYSTEM NSX-F 9959
24.17.008	AIWA NSX 2200.999. 9000 F7 NV 8080
24.17.009	AIWA NSX 302. 303. 305
24.17.010	AIWA NSX 500. 3000
24.17.011	AIWA NSX-F 505. NSX-Z 51. NSX-Z 779
24.17.012	AIWA NSX-S 95
24.17.013	AIWA NSX-S 32
24.17.014	AIWA NSX-S 505
24.17.015	AIWA NSX-SZ 21. NSX-D25. NSX 329
24.17.016	AIWA NSX-V 70
24.17.017	AIWA NSX-Z 1300
24.17.018	AIWA NSX-Z 30
24.17.019	AIWA NSX-Z 50
24.17.020	AIWA NSX-Z 870.Z 1200
24.17.021	CCE LX 15
24.17.022	CCE MD 3200. 3260. 3280
24.17.023	CCE UNIVERSAL DUPLO-DECK

CÓDIGO	DESCRIÇÃO
24.17.024	GRADIENTE AS 302
24.17.025	GRADIENTE AT2. AT3.ATX
24.17.026	GRADIENTE DS 25. DS 30
24.17.027	GRADIENTE K-700
24.17.028	GRADIENTE MS-200
24.17.029	GRADIENTE TK 43
24.17.030	GRADIENTE TK 53
24.17.031	GRADIENTE VC-403
24.17.032	PHILIPS - RADIO GRAVADOR AZ 1010.1030.1050 E OUTROS
24.17.033	PHILIPS FW 360
24.17.034	SONY FHB 7. FHB 170. FHB 711
24.17.035	SONY FHB-500
24.17.036	SONY FHB-511
24.17.037	SONY FHG-33
24.17.038	SONY FHG-50
24.17.039	SONY FHG-8 AV. FHG-88 AV
24.17.040	SONY GRX 8000. 9000
24.17.041	SONY LBT 30 AW. 32 AW
24.17.042	SONY LBT 555
24.17.043	SONY LBT A-495
24.17.044	SONY LBT-N 350
24.17.045	SONY MHC-DX. DXI. DX5. DX7. DX9. RG-66T
24.17.046	TOSHIBA 6230. 6226
24.17.047	TOSHIBA CM 6237

Todos os nomes, logotipos de empresas e produtos citados neste catálogo são marcas registradas de suas respectivas corporações. A citação dos mesmos tem a única intenção de auxiliar nossos clientes na identificação de nossos produtos que são compatíveis com os originais.



15.00.001
ALTA TENSÃO
12KVA AXIAL ESJC 01-12BX



15.00.005
DIODO ALTA TENSÃO DUPLO
HV 6X2PI 3-15 KVA 350MA



DIODO
15.04.000 - 6A8 6A/800V
15.04.001 - 6A10A/1000V

Diodo Led

3MM (CENTO)

- 15.02.000 AMARELO DIFUSO.....
- 15.02.001 VERDE DIFUSO.....
- 15.02.002 VERMELHO DIFUSO.....

5MM (CENTO)

- 15.02.003 AMARELO DIFUSO.....
- 15.02.008 VERDE DIFUSO.....
- 15.02.009 VERMELHO DIFUSO.....

5MM (UNID.)

- 15.02.046 BICOLOR VM/VD.....
- 15.02.005 1800 MCD TRANSP VERM.....
- 15.02.006 15000 MCD TRANSP AZUL.....
- 15.02.007 11000 MCD TRANSP BRANCO.....
- 15.02.029 5000 MCD TRANSP AMARELO.....
- 15.02.042 5000 MCD TRANSP BRANCO.....



- 15.02.043 10000 MCD TRANSP VERDE.....
- 15.02.044 10000 MCD TRANSP AZUL.....
- 15.02.045 4000 MCD TRANSP RGB 2T.....

10MM (UNID.)

- 15.02.010 4000 MCD TRANSP AZUL.....
- 15.02.011 4000 MCD TRANSP BRANCO.....
- 15.02.012 800 MC TRANSP VERMELHO.....

RETANGULAR (CENTO)

- 15.02.013 RETANGULAR AMARELO...
- 15.02.014 RETANGULAR VERDE.....

Diodo Retificador

- 15.01.000 - IN 5062.....
- 15.03.008 - SR360 3A 60V.....
- 15.03.010 - MBRF 10100 CT.....
- 15.04.002 - BYV 28-200 / 20 3,5AMP X 200V.....

- 15.04.019 -SB 3200.....
- 15.04.020 - RL 206 800V 2A.....
- 15.04.021 - BA 158.....

Ponte Retificadora



- 15.11.000 - 25A/1000V KBPC 2510.....
- 15.11.001 - 35A/1000V KBPC 3510.....
- 15.11.003 - 50A/ 1000V KBPC 5010.....

Retificador, Sinal e Zenner

- 15.04.014 - IN 4007 - (CENTO).....
- 15.04.018 - IN 4937 - (CENTO).....
- 15.04.015 - IN 5408 - 3A/800V - (UNIDADE).....
- 15.05.000 - IN 4148 (CENTO).....

Varistor

- 15.06.002 7MM - 07D151K - 95V.....
- 15.06.003 7MM - 07D241K - 150V.....
- 15.06.004 7MM - 07D391K - 250V.....
- 15.06.008 10MM - 10D121K - 75V.....
- 15.06.009 10MM - 10D201K - 130V.....
- 15.06.010 10MM - 10D241K - 150V.....
- 15.06.012 10MM - 10D391K - 250V.....

- 15.06.013 10MM - 10D431K - 275V.....
- 15.06.017 14MM - 14D201K - 130V.....
- 15.06.018 14MM - 14D241K - 150V.....
- 15.06.033 14MM 175V.....
- 15.06.019 14MM - 14D361K - 230V.....
- 15.06.020 14MM - 14D391K - 250V.....
- 15.06.021 14MM - 14D431K - 275V.....
- 15.06.022 14MM - 14D471K - 300V.....

- 15.06.024 20MM - TVR 20121 - 75V.....
- 15.06.026 20MM - 20D241K - 150V.....
- 15.06.027 20MM - TVR 20361 - 230V.....
- 15.06.028 20MM - 20D391K - 250V.....
- 15.06.029 20MM 275V.....
- 15.06.030 20MM 300V.....

DIODO ZENER 0,5W

- 15.07.055 - 2V4 1N 5221 = BZX55C2V4
- 15.07.058 - 3V0 1N 5225=BZX55C3V0
- 15.07.059 - 3V3 1N 5226=BZX55C3V3
- 15.07.060 - 3V6 1N 5227=BZX55C3V6
- 15.07.061 - 3V9 1N 5228=BZX55C3V9
- 15.07.062 - 4V3 1N 5229=BZX55C4V3
- 15.07.063 - 4V7 1N 5230=BZX55C4V7
- 15.07.064 - 5V1 1N 5231=BZX55C5V1
- 15.07.065 - 5V6 1N 5232=BZX55C5V6
- 15.07.066 - 6V2 1N 5235=BZX55C6V2
- 15.07.067 - 6V8 1N 5235=BZX55C6V8
- 15.07.068 - 7V5 1N 5236=BZX55C7V5
- 15.07.069 - 8V2 1N 5237=BZX55C8V2
- 15.07.070 - 9V1 1N 5239=BZX55C9V1
- 15.07.071 - 10V 1N 5240=BZX55C10V
- 15.07.072 - 11V BZX55V11V
- 15.07.073 - 12V 1N 5242=BZX55C12V
- 15.07.074 - 13V BZX55C13V
- 15.07.075 - 15V 1N 5245=BZX55C15V
- 15.07.076 - 16V BZX55C16V
- 15.07.078 - 20V 1N 5250=BZX55C20V
- 15.07.080 - 22V 1N 5251=BZX55C22V
- 15.07.081 - 24V 1N 5252=BZX55V24V
- 15.07.082 - 27V 1N 5254=BZX55C27V
- 15.07.083 - 30V 1N 5256=BZX55C30V
- 15.07.084 - 33V 1N 5257=BZX55C33V
- 15.07.085 - 36V 1N 5258=BZX55C36V
- 15.07.086 - 39V 1N 5259=BZX55C39V
- 15.07.087 - 43V 1N 5260=BZX55C43V
- 15.07.088 - 47V 1N 5261=BZX55C47V

DIODO ZENER 1W

- 15.07.101 - 3V3 1N4728
- 15.07.102 - 3V6 1N4729A
- 15.07.103 - 3V9 1N4730A
- 15.07.104 - 4V3 1N4731A
- 15.07.105 - 4V7 1N4732
- 15.07.106 - 5V1 1N4733
- 15.07.107 - 5V6 1N4734
- 15.07.108 - 6V2 1N4735
- 15.07.109 - 6V8 1N4736
- 15.07.110 - 7V5 1N4737
- 15.07.111 - 8V2 1N4738
- 15.07.112 - 9V1 1N4739
- 15.07.113 - 10V 1N 4740
- 15.07.156 - 11V 1N 4741A
- 15.07.114 - 12V 1N 4742
- 15.07.115 - 13V 1N 4743
- 15.07.116 - 15V 1N 4744
- 15.07.117 - 16V 1N 4745
- 15.07.118 - 18V 1N 4746
- 15.07.119 - 20V 1N 4747
- 15.07.120 - 22V 1N 4748
- 15.07.121 - 24V 1N 4749
- 15.07.122 - 27V 1N 4750
- 15.07.124 - 33V 1N4752
- 15.07.125 - 36V 1N4753A
- 15.07.126 - 39V 1N4754A
- 15.07.127 - 43V 1N4755A
- 15.07.129 - 51V 1N4757
- 15.07.131 - 62V 1N4759
- 15.07.133 - 75V 1N4761

DIODO ZENER 5W

- 15.07.134 - 5V6 1N5339B
- 15.07.135 - 6V2 1N5341B
- 15.07.136 - 6V8 1N5342B
- 15.07.137 - 7V5 1N5343B
- 15.07.138 - 9V1 1N5346B
- 15.07.139 - 10V 1N5347B
- 15.07.140 - 12V 1N5349B
- 15.07.141 - 13V 1N5350B
- 15.07.142 - 14V 1N5351B
- 15.07.143 - 15V 1N5352B
- 15.07.144 - 16V 1N5353B
- 15.07.145 - 20V 1N 5357B
- 15.07.146 - 22V 1N5358B
- 15.07.147 - 24V 1N5359B
- 15.07.148 - 27V 1N5361B
- 15.07.149 - 33V 1N5364B
- 15.07.150 - 36V 1N5365B
- 15.07.151 - 47V 1N5368B
- 15.07.152 - 75V 1N5374B
- 15.07.153 - 120V 1N5380B
- 15.07.154 - 150V 1N5383B
- 15.07.155 - 200V 1N5388B

DIODO ZENER 5W

- 15.07.156 - 5V1 1N5338



15.08.000
ROSCA 3MM CROMADO



15.08.001
ROSCA 3MM CROMADO



15.08.003
ROSCA 3MM PRETO



15.08.004
ROSCA 5MM CROMADO



15.08.005
ROSCA 5MM CROMADO



15.08.007
ROSCA 5MM PRETO

MÚLTIPLO 10 Pcs



19.01.000
FUSÍVEL DE VIDRO RETARDO 0,80 A (6X40MM)

NOVO



PORTA FUSÍVEL PARA MICROONDAS
19.06.025 - S/ FUSÍVEL
19.06.026 - C/ FUSÍVEL

MÚLTIPLO 10 Pcs



FUSÍVEL DE CERÂMICA 6X30
19.00.009 5 A
19.00.000 8 A
19.00.001 10 A
19.00.002 12 A
19.00.003 15 A
19.00.004 20 A
19.00.011 25 A

MÚLTIPLO 10 Pcs



FUSÍVEL DE CERÂMICA PEQUENO C-20AGKF C/ AREIA NACIONAL
19.00.015 - 3,15A
19.00.016 - 3,5A
19.00.018 - 6A
19.00.019 - 8A
19.00.020 - 10A
19.00.021 - 12A
19.00.022 - 15A
19.00.023 - 20A
19.00.024 - 25A

MÚLTIPLO 10 Pcs



FUSÍVEL DE CERÂMICA PEQUENO 5X20
19.00.030 - 8A
19.00.031 - 10A
19.00.032 - 15A
19.00.033 - 20A

MÚLTIPLO 10 Pcs



FUSÍVEL DE CERÂMICA GRANDE C/ AREIA NACIONAL 6X30
19.00.029 - 10A
19.00.027 - 15A
19.00.028 - 20A
19.00.038 - 25A

MÚLTIPLO 10 Pcs



FUSÍVEL CERÂMICO AXIAL PEQUENO 5X20
19.00.034 - 3,15A
19.00.035 - 5A
19.00.036 - 6,3A
19.00.037 - 10A

MÚLTIPLO 10 Pcs



28.00.000
FUSISTOR 1/2 W 0R10

FUSÍVEL DE VIDRO 3AG GRD

19.02.010 0,1 A	19.02.001 3 A	19.02.024 12 A
19.02.012 0,25A	19.02.022 3,5 A	19.02.008 15 A
19.02.013 0,3 A	19.02.002 4 A	19.02.009 20 A
19.02.014 0,5 A	19.02.003 5 A	19.02.025 25 A
19.02.027 0,7 A	19.02.004 6 A	19.02.026 30 A
19.02.016 0,8 A	19.02.023 6,3 A	
19.02.017 1 A	19.02.005 7 A	
19.02.019 1,5 A	19.02.037 9 A	
19.02.000 2 A	19.02.006 8 A	
19.02.020 2,5 A	19.02.007 10 A	

FUSÍVEL DE VIDRO 20AG PEQ

19.03.014 0,1 A	19.03.021 1,5 A	19.03.023 8 A
19.03.000 0,15A	19.03.004 2 A	19.03.035 9 A
19.03.016 0,25A	19.03.005 2,5 A	19.03.013 10.A
19.03.017 0,3 A	19.03.006 3 A	19.03.024 12.A
19.03.001 0,5 A	19.03.007 3,15A	19.03.025 15 A
19.03.018 0,6 A	19.03.008 3,5 A	19.03.026 20.A
19.03.019 0,7 A	19.03.009 4 A	19.03.027 25.A
19.03.032 750MA	19.03.010 5 A	19.03.028 30.A
19.03.002 0,8 A	19.03.011 6 A	
19.03.003 1 A	19.03.022 6,3 A	
19.03.020 1,25 A	19.03.012 7 A	



MÚLTIPLO 10 Pcs

FUSÍVEL DE PICO

19.05.013 0,200A.....
19.05.001 0,315A.....
19.05.002 0,400A.....
19.05.003 0,500A.....
19.05.004 0,630A.....
19.05.005 0,800A.....
19.05.006 1,00 A.....
19.05.007 1,25 A.....
19.05.008 1,60 A.....
19.05.009 2,00 A.....
19.05.010 3,15A.....
19.05.011 4,00A.....
19.05.012 5,00A.....
19.05.014 7,00A.....



28.06.001
TERMISTOR DSC30-15
USADO NAS TVS LED LCD PHILIPS



28.06.002
TERMISTOR DSC 10D-9



28.06.003
TERMISTOR NTC 10D2-10

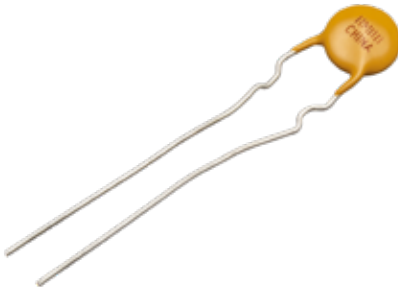

28.06.004
FUSÍVEL REAJUSTÁVEL 72V 0,50A - PPTC



09.03.013
POLYFUSE PTC RXE065XU



04.03.000
MICRO CHOQUE INDUTOR 1000UH

Fusível Lâmina
MINI

- 19.07.036 - 3A
- 19.07.037 - 4 A
- 19.07.038 - 5 A
- 19.07.039 - 7,5 A
- 19.07.040 - 10 A
- 19.07.041 - 15 A
- 19.07.042 - 20 A
- 19.07.043 - 25 A
- 19.07.044 - 30 A
- 19.07.045 - 35 A

MÉDIO

- 19.07.025 - 3 A
- 19.07.026 - 4 A
- 19.07.027 - 5 A
- 19.07.028 - 7,5 A
- 19.07.029 - 10 A
- 19.07.030 - 15 A
- 19.07.031 - 20 A
- 19.07.032 - 25 A
- 19.07.033 - 30 A
- 19.07.034 - 35 A
- 19.07.035 - 40 A

GRANDE

- 19.07.018 - 30 A
- 19.07.019 - 40 A
- 19.07.020 - 50 A
- 19.07.021 - 60 A
- 19.07.022 - 70 A
- 19.07.023 - 80 A
- 19.07.024 - 100 A

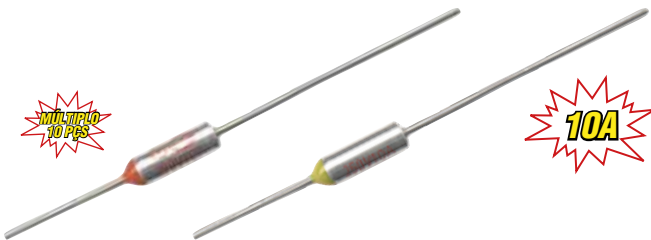
Fusível Térmico

FUSÍVEL TÉRMICO 10A 250V

- | | | |
|-------------------|----------------|----------------|
| 19.04.008 85° | 19.04.015 140° | 19.04.027 216° |
| 19.04.009 92° | 19.04.016 150° | 19.04.023 227° |
| 19.04.010 99° | 19.04.017 160° | 19.04.024 240° |
| 19.04.003 100° | 19.04.018 165° | 19.04.001 229° |
| 19.04.006 102° 1A | 19.04.019 180° | 19.04.002 245° |
| 19.04.011 102° | 19.04.020 184° | 19.04.004 250° |
| 19.04.012 120° | 19.04.021 185° | |
| 19.04.013 123° | 19.04.022 192° | |
| 19.04.014 130° | 19.04.000 215° | |

FUSÍVEL TÉRMICO 15A

- | | | |
|----------------|----------------|----------------|
| 19.04.034 102° | 19.04.042 184° | |
| 19.04.035 120° | 19.04.043 185° | |
| 19.04.036 123° | 19.04.044 192° | |
| 19.04.037 130° | 19.04.045 215° | 19.04.030 240° |
| 19.04.038 140° | 19.04.028 216° | 19.04.031 245° |
| 19.04.040 165° | 19.04.029 227° | 19.04.032 250° |
| 19.04.041 180° | 19.04.025 229° | 19.04.033 260° |

15A
FUSÍVEL TÉRMICO P/ VENTILADOR

- 19.08.000 130° 2A
- 19.08.001 130° 3A

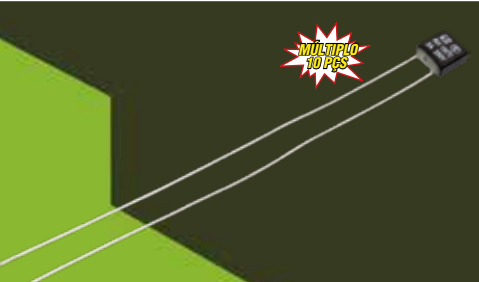

Todos os nomes, logotipos de empresas e produtos citados neste catálogo são marcas registradas de suas respectivas corporações. A citação dos mesmos tem a única intenção de auxiliar nossos clientes na identificação de nossos produtos que são compatíveis com os originais.

FITA DE LED

COM PROTEÇÃO DE SILICONE



15.12.008
 FITA DE LED SMD 3528 60 LEDS/MT TENSÃO 12V,
 CORTE A CADA 3 LEDS FITA ADESIVA DUPLA FACE
 PROTEÇÃO: IP65
 COR: BRANCA FRIA



15.12.009
 FITA DE LED SMD 3528 60 LEDS/MT TENSÃO 12V,
 CORTE A CADA 3 LEDS FITA ADESIVA DUPLA FACE
 PROTEÇÃO: IP65
 COR: VERDE

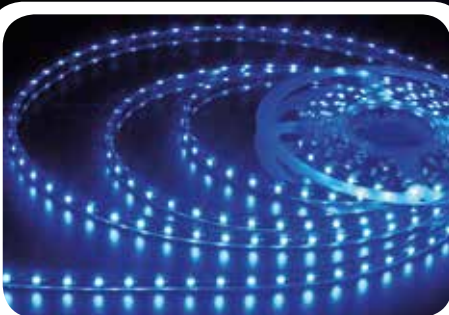

15.12.007
 FITA DE LED SMD 3528 60 LEDS/MT TENSÃO 12V,
 CORTE A CADA 3 LEDS FITA ADESIVA DUPLA FACE
 PROTEÇÃO: IP65
 COR: AZUL



15.12.011
 FITA DE LED SMD 3528 60 LEDS/MT TENSÃO 12V,
 CORTE A CADA 3 LEDS FITA ADESIVA DUPLA FACE
 PROTEÇÃO: IP65
 COR: BR. QUENTE



24.26.008
 CONTROLADOR RGB P/FITA DE LED



15.12.010
 FITA DE LED SMD 3528 60 LEDS/MT TENSÃO 12V,
 CORTE A CADA 3 LEDS FITA ADESIVA DUPLA FACE
 PROTEÇÃO: IP65
 COR: VERMELHA



15.12.012
 FITA DE LED SMD 5050 30 LEDS/MT TENSÃO 12V,
 CORTE A CADA 3 LEDS FITA ADESIVA DUPLA FACE
 PROTEÇÃO: IP65
 COR: RGB
 SEM CONTROLADOR

Todos os nomes, logotipos de empresas e produtos citados neste catálogo são marcas registradas de suas respectivas corporações. A citação dos mesmos tem a única intenção de auxiliar nossos clientes na identificação de nossos produtos que são compatíveis com os originais.



19.06.010
PORTA FUSÍVEL GAVETA PRETA 5X20
AS 06



19.06.011
PORTA FUSÍVEL GAVETA PRETA 5X20
BF 020



19.06.006
PORTA FUSÍVEL 20AG PEQ. AXIAL

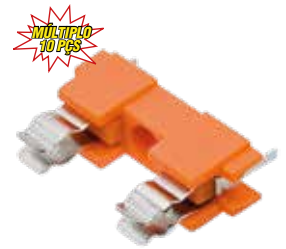

19.06.005
PORTA FUSÍVEL 20AG PEQ. RADIAL



19.06.016 - GDE.
19.06.000 - PEQ.
PORTA FUSÍVEL BAIONETA C/ FIO



19.06.020
PORTA FUSÍVEL TIPO ROSCA FUSIBRAS PF0550



19.06.021
PORTA FUSÍVEL ENGATE RÁPIDO FUSIBRAS PF0520

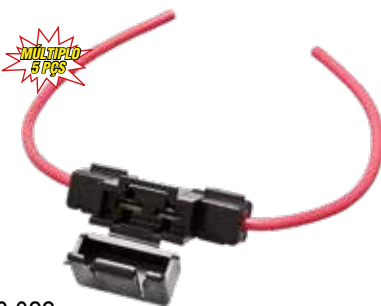

19.06.022
PORTA FUSÍVEL AÉREO FUSIBRAS PF1550



19.06.023
PORTA FUSÍVEL PARA PAINEL / AÉREO FUSIBRAS
PF 2550



19.06.024
PORTA FUSÍVEL AÉREO PARA FUSÍVEIS DE LÂMINA
MAX PF3564



PORTA FUSÍVEL PEQUENO
19.06.004 - TAMPA PRETA
19.06.013 - TAMPA VERMELHA



PORTA FUSÍVEL GRANDE
19.06.002 - TAMPA PRETA
19.06.009 - TAMPA VERMELHA

Garra Jacaré



37MM PEQUENA
ISOLADA
20.00.000 - PT
20.00.001 - VM



43MM MÉDIO
ISOLADA
20.00.008 - PT
20.00.009 - VM



53MM GRANDE
ISOLADA
20.00.010 - PT
20.00.011 - VM



FUSIBRAS 38MM GJ 700
MEIA ISOLAÇÃO PT GJ
0700
20.01.000 - PT
20.01.001 - VM



GARRA JACARÉ
SEMI-ISOLADA
C/ PARAFUSO
20.01.011 - PT
20.01.012 - VM



GARRA JACARÉ
IMPORTADA
20.01.013 - PT
20.01.014 - VM



GARRA JACARÉ 50A
20.01.017 - PT
20.01.018 - VM



GARRA JACARÉ
GDE. BATERIA 100A
20.01.015 - PT
20.01.016 - VM



40MM GJ 705 ISOLADA
20.00.002 - AM
20.00.003 - AZ
20.00.004 - PT
20.00.005 - VD
20.00.006 - VM



50MM MOD. 511 MEIA
ISOLAÇÃO P/ BATERIA
20.01.003 - PT
20.01.002 - VM

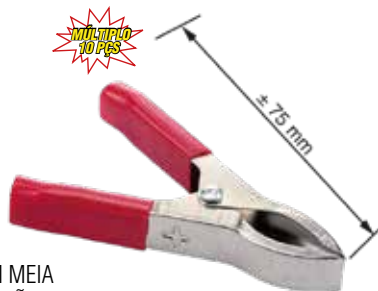

75MM MEIA
ISOLAÇÃO P/ BATERIA
20.01.008 - PT
20.01.009 - VM



57MM GBI 12
ISOLADA
P/ BATERIA
20.00.012 - PT
20.00.013 - VM



79MM GJ 720 ISOLADA
20.00.014 - AM
20.00.015 - AZ
20.00.016 - PT
20.00.017 - VD
20.00.018 - VM



110MM GI 30 ISOLADA P/ BATERIA
20.00.023 - PT
20.00.024 - VM



165MM GI 35 ISOLADA P/ BATERIA
20.00.025 - PT
20.00.026 - VM

Microfone Eletreto



01.45.000
10X 7 SOLDA



01.45.001
6X 3 SOLDA



Motor Comum

22.01.003
MOTOR 5,9V EIXO MÉDIO
6MM P/ APARELHO DVD



daxxia

UMA LINHA COMPLETA DE PRODUTOS PARA SUA NECESSIDADE

Todos os nomes, logotipos de empresas e produtos citados neste catálogo são marcas registradas de suas respectivas corporações. A citação dos mesmos tem a única intenção de auxiliar nossos clientes na identificação de nossos produtos que são compatíveis com os originais.



16.01.011
ÁLCOOL AEROSOL 180G/300ML TND

MÚLTIPLO 6 PÇS

16.15.012
LIMPA CONTATO AEROSOL 170GR/300ML TND

16.15.016
DESENGRAXANTE AEROSOL 200GR/300ML

16.16.007
LUBRIFICANTE GRAXA LITIO BC 200GR/300ML

MÚLTIPLO 6 PÇS

16.16.008
LUBRIFICANTE ANTICORROSIVO

16.16.005
LUBRIFICANTE SILICONE 170GR/300ML

16.14.022
GRAXA DE ALTA ADERÊNCIA AEROSOL 200G/300ML

MÚLTIPLO 6 PÇS

14.14.021
LUBRIFICANTE VASELINA AEROSOL 200GR/300ML

14.14.020
GRAFITE EM PÓ A SECO AEROSOL 200GR/300ML



- 21.08.019 - BRANCA
- 21.08.020 - PRETA
- 21.08.021 - VERMELHA
- 21.08.022 - AMARELA
- 21.08.023 - ALUMÍNIO
- 21.08.024 - DOURADO

MÚLTIPLO 6 PÇS

TINTA DAXXIA ALTA-TEMPERATURA 300ML

- DE 6 A 18 PÇS.....
- DE 19 A 30 PÇS.....
- DE 31 A 42 PÇS.....
- DE 43 A 54 PÇS.....
- ACIMA DE 54 PÇS.....

daxxia

MÚLTIPLO 6 PÇS

MÚLTIPLO 6 PÇS

16.01.011
AEROSOL 180G/300ML



CONSULTE
PREÇO PARA
QUANTIDADE

16.13.007
FLUXO NO-CLEAN
300ML



16.03.000
CAMISINHA BICO SUGADOR
BLISTER 250° BLISTER 1 PÇ



16.03.001
CAMISINHA BICO SUGADOR
BLISTER 250° BLISTER 3 PÇS



16.09.000
DESSOLDADOR
BLISTER BARRA AVULSA



16.09.001
DESSOLDADOR
BLISTER KIT 1 BARRA



16.09.002
DESSOLDADOR
BLISTER KIT 10 BARRA

Ultra Cleaning

Limpador de uso geral



Isopropanol

Álcool Isopropílico
Limpador de uso geral



16.01.021 - 110ML
16.01.022 - 250ML
16.01.023 - 500ML
16.01.024 - 1 LITRO
16.01.025 - 5 LITROS

16.01.016 - 110ML
16.01.018 - 250ML
16.01.019 - 500ML
16.01.015 - 1 LITRO
16.01.020 - 5 LITROS

ENCARTELADOS

daxxia

www.daxxia.com.br

Todos os nomes, logotipos de empresas e produtos citados neste catálogo são marcas registradas de suas respectivas corporações. A citação dos mesmos tem a única intenção de auxiliar nossos clientes na identificação de nossos produtos que são compatíveis com os originais.



NOVO
29.00.009
FIXA FIO
5MM



NOVO
29.00.010
FIXA FIO
6MM



CARTELA COM 10 PEÇAS
102.53.007
REBITE REPUXO ALUMÍNIO POLIDO
BRILHANTE 3,20 X 12 (1/2")



CARTELA COM 10 PEÇAS
102.53.009
REBITE REPUXO ALUMÍNIO POLIDO
BRILHANTE 3,20 X 16 (5/8")



CARTELA COM 10 PEÇAS
102.53.021
REBITE REPUXO ALUMÍNIO POLIDO
BRILHANTE 4,00 X 16 (5/8")



CARTELA COM 07 PEÇAS
102.53.031
REBITE REPUXO ALUMÍNIO POLIDO
BRILHANTE 4,80 X 12 (1/2")



CARTELA COM 06 PEÇAS
102.53.033
REBITE REPUXO ALUMÍNIO POLIDO
BRILHANTE 4,80 X 16 (5/8")



CARTELA COM 06 PEÇAS
102.53.035
REBITE REPUXO ALUMÍNIO POLIDO
BRILHANTE 4,80 X 22 (7/8")



102.45.001
PAR BROCA FIX SEXTAVADO C ARRUELA
ROSCA BROCA PERFURANTE 4,2 (#08) X
5/8" (16MM)



102.45.012
PAR BROCA FIX SEXTAVADO C ARRUELA
ROSCA BROCA PERFURANTE 5,5 (#12) X
1" 1/2 (38MM)



102.45.013
PAR BROCA FIX SEXTAVADO C ARRUELA
ROSCA BROCA PERFURANTE 5,5 (#12) X
2" (50MM)



102.44.000
PAR BROCA FIX CABEÇA FLANGEADA
FENDA PHILIPS ROSCA BROCA
PERFURANTE 4,2 (#08) X 1/2" (13MM)



102.01.002
PAR AUTO FIX CABEÇA CHATA FENDA
PHILIPS ROSCA AUTO ATARRACHANTE
TIPO C ZINCADO DIN 7892 2,90 X 13
(1/2")



102.01.008
PAR AUTO FIX CABEÇA CHATA FENDA
PHILIPS ROSCA AUTO ATARRACHANTE
TIPO C ZINCADO DIN 7892 3,50 X 16
(5/8")



102.01.009
PAR AUTO FIX CABEÇA CHATA FENDA
PHILIPS ROSCA AUTO ATARRACHANTE
TIPO C ZINCADO DIN 7892 3,50 X 19
(3/4")



102.01.015
PAR AUTO FIX CABEÇA CHATA FENDA
PHILIPS ROSCA AUTO ATARRACHANTE
TIPO C ZINCADO DIN 7892 3,90 X 19
(3/4")



102.01.017
PAR AUTO FIX CABEÇA CHATA FENDA
PHILIPS ROSCA AUTO ATARRACHANTE
TIPO C ZINCADO DIN 7892 3,90 X 25 (1")



102.01.025
PAR AUTO FIX CABEÇA CHATA FENDA
PHILIPS ROSCA AUTO ATARRACHANTE
TIPO C ZINCADO DIN 7892 4,20 X 32
(1.1/4")



102.03.002
PAR AUTO FIX CABEÇA PANELA FENDA
PHILIPS ROSCA AUTO ATARRACHANTE
TIPO C ZINCADO DIN 7981 2,90 X 13 (1/2")



102.03.008
PAR AUTO FIX CABEÇA PANELA FENDA
PHILIPS ROSCA AUTO ATARRACHANTE
TIPO C ZINCADO DIN 7981 3,50 X 16
(5/8")

Todos os nomes, logotipos de empresas e produtos citados neste catálogo são marcas registradas de suas respectivas corporações. A citação dos mesmos tem a única intenção de auxiliar nossos clientes na identificação de nossos produtos que são compatíveis com os originais.



102.03.010
PAR AUTO FIX CABEÇA PANELA FENDA
PHILIPS ROSCA AUTO ATARRACHANTE
TIPO C ZINCADO DIN 7981 3,50 X 22
(7/8")



102.03.011
PAR AUTO FIX CABEÇA PANELA FENDA
PHILIPS ROSCA AUTO ATARRACHANTE
TIPO C ZINCADO DIN 7981 3,50 X 25 (1")



102.03.015
PAR AUTO FIX CABEÇA PANELA FENDA
PHILIPS ROSCA AUTO ATARRACHANTE
TIPO C ZINCADO DIN 7981 3,90 X 19
(3/4")



102.03.018
PAR AUTO FIX CABEÇA PANELA FENDA
PHILIPS ROSCA AUTO ATARRACHANTE
TIPO C ZINCADO DIN 7981 3,90 X 32
(1.1/4")



102.03.024
PAR AUTO FIX CABEÇA PANELA FENDA
PHILIPS ROSCA AUTO ATARRACHANTE
TIPO C ZINCADO DIN 7981 4,20 X 25 (1")



102.03.025
PAR AUTO FIX CABEÇA PANELA FENDA
PHILIPS ROSCA AUTO ATARRACHANTE
TIPO C ZINCADO DIN 7981 4,20 X 32
(1.1/4")



102.03.026
PAR AUTO FIX CABEÇA PANELA FENDA
PHILIPS ROSCA AUTO ATARRACHANTE
TIPO C ZINCADO DIN 7981 4,20 X 38
(1.1/2")



102.03.033
PAR AUTO FIX CABEÇA PANELA FENDA
PHILIPS ROSCA AUTO ATARRACHANTE
TIPO C ZINCADO DIN 7981 4,80 X 32
(1.1/4")



102.03.034
PAR AUTO FIX CABEÇA PANELA FENDA
PHILIPS ROSCA AUTO ATARRACHANTE
TIPO C ZINCADO DIN 7981 4,80 X 38
(1.1/2")



102.03.036
PAR AUTO FIX CABEÇA PANELA FENDA
PHILIPS ROSCA AUTO ATARRACHANTE
TIPO C ZINCADO DIN 7981 4,80 X 50 (2")



102.03.045
PAR AUTO FIX CABEÇA PANELA FENDA
PHILIPS ROSCA AUTO ATARRACHANTE
TIPO C ZINCADO DIN 7981 5,50 X 50 (2")



102.28.000
PAR CHIP FIX CABEÇA CHATA FENDA
PHILIPS ROSCA AUTO CORTANTE
BICROMATIZADO 3,00 X 10 (3/8")



102.28.008
PAR CHIP FIX CABEÇA CHATA FENDA
PHILIPS ROSCA AUTO CORTANTE
BICROMATIZADO 3,50 X 10 (3/8")



102.28.009
PAR CHIP FIX CABEÇA CHATA FENDA
PHILIPS ROSCA AUTO CORTANTE
BICROMATIZADO 3,50 X 12 (1/2")



102.28.010
PAR CHIP FIX CABEÇA CHATA FENDA
PHILIPS ROSCA AUTO CORTANTE
BICROMATIZADO 3,50 X 14 (9/16")



102.28.011
PAR CHIP FIX CABEÇA CHATA FENDA
PHILIPS ROSCA AUTO CORTANTE
BICROMATIZADO 3,50 X 16 (5/8")



102.28.014
PAR CHIP FIX CABEÇA CHATA FENDA
PHILIPS ROSCA AUTO CORTANTE
BICROMATIZADO 3,50 X 25 (1")



102.28.015
PAR CHIP FIX CABEÇA CHATA FENDA
PHILIPS ROSCA AUTO CORTANTE
BICROMATIZADO 3,50 X 30 (1.3/16")



102.28.016
PAR CHIP FIX CABEÇA CHATA FENDA
PHILIPS ROSCA AUTO CORTANTE
BICROMATIZADO 3,50 X 35 (1.3/8")



102.28.017
PAR CHIP FIX CABEÇA CHATA FENDA
PHILIPS ROSCA AUTO CORTANTE
BICROMATIZADO 3,50 X 40 (1.1/2")



102.28.019
PAR CHIP FIX CABEÇA CHATA FENDA
PHILIPS ROSCA AUTO CORTANTE
BICROMATIZADO 4,00 X 12 (1/2")



102.28.021
PAR CHIP FIX CABEÇA CHATA FENDA
PHILIPS ROSCA AUTO CORTANTE
BICROMATIZADO 4,00 X 16 (5/8")



102.28.022
PAR CHIP FIX CABEÇA CHATA FENDA
PHILIPS ROSCA AUTO CORTANTE
BICROMATIZADO 4,00 X 20 (3/4")



102.28.024
PAR CHIP FIX CABEÇA CHATA FENDA
PHILIPS ROSCA AUTO CORTANTE
BICROMATIZADO 4,00 X 25 (1")

Todos os nomes, logotipos de empresas e produtos citados neste catálogo são marcas registradas de suas respectivas corporações. A citação dos mesmos tem a única intenção de auxiliar nossos clientes na identificação de nossos produtos que são compatíveis com os originais.



102.28.025
PAR CHIP FIX CABEÇA CHATA FENDA
PHILIPS ROSCA AUTO CORTANTE
BICROMATIZADO 4,00 X 30 (1.3/16")



102.28.026
PAR CHIP FIX CABEÇA CHATA FENDA
PHILIPS ROSCA AUTO CORTANTE
BICROMATIZADO 4,00 X 35 (1.3/8")



102.28.029
PAR CHIP FIX CABEÇA CHATA FENDA
PHILIPS ROSCA AUTO CORTANTE
BICROMATIZADO 4,00 X 50 (2")



102.28.033
PAR CHIP FIX CABEÇA CHATA FENDA
PHILIPS ROSCA AUTO CORTANTE
BICROMATIZADO 4,50 X 20 (3/4")



102.28.035
PAR CHIP FIX CABEÇA CHATA FENDA
PHILIPS ROSCA AUTO CORTANTE
BICROMATIZADO 4,50 X 25 (1")



102.28.037
PAR CHIP FIX CABEÇA CHATA FENDA
PHILIPS ROSCA AUTO CORTANTE
BICROMATIZADO 4,50 X 35 (1.3/8")



102.28.039
PAR CHIP FIX CABEÇA CHATA FENDA
PHILIPS ROSCA AUTO CORTANTE
BICROMATIZADO 4,50 X 45 (1.3/4")



102.28.042
PAR CHIP FIX CABEÇA CHATA FENDA
PHILIPS ROSCA AUTO CORTANTE
BICROMATIZADO 5,00 X 25 (1")



102.28.044
PAR CHIP FIX CABEÇA CHATA FENDA
PHILIPS ROSCA AUTO CORTANTE
BICROMATIZADO 5,00 X 35 (1.3/8")



102.28.048
PAR CHIP FIX CABEÇA CHATA FENDA
PHILIPS ROSCA AUTO CORTANTE
BICROMATIZADO 5,00 X 60 (2.3/8")



102.28.049
PAR CHIP FIX CABEÇA CHATA FENDA
PHILIPS ROSCA AUTO CORTANTE
BICROMATIZADO 5,00 X 70 (2.3/4")



102.28.051
PAR CHIP FIX CABEÇA CHATA FENDA
PHILIPS ROSCA AUTO CORTANTE
BICROMATIZADO 6,00 X 30 (1.3/16")



102.29.010
PAR CHIP FIX CABEÇA PANELA FENDA
PHILIPS ROSCA AUTO CORTANTE
BICROMATIZADO 3,50 X 14 (9/16")



102.29.011
PAR CHIP FIX CABEÇA PANELA FENDA
PHILIPS ROSCA AUTO CORTANTE
BICROMATIZADO 3,50 X 16 (5/8")



102.29.014
PAR CHIP FIX CABEÇA PANELA FENDA
PHILIPS ROSCA AUTO CORTANTE
BICROMATIZADO 3,50 X 25 (1")



102.29.024
PAR CHIP FIX CABEÇA PANELA FENDA
PHILIPS ROSCA AUTO CORTANTE
BICROMATIZADO 4,00 X 25 (1")



102.29.026
PAR CHIP FIX CABEÇA PANELA FENDA
PHILIPS ROSCA AUTO CORTANTE
BICROMATIZADO 4,00 X 35 (1.3/8")



102.29.027
PAR CHIP FIX CABEÇA PANELA FENDA
PHILIPS ROSCA AUTO CORTANTE
BICROMATIZADO 4,00 X 10 (1.1/2")



102.29.048
PAR CHIP FIX CABEÇA PANELA FENDA
PHILIPS ROSCA AUTO CORTANTE
BICROMATIZADO 5,00 X 50 (2")



102.48.000
PAR DRY FIX CABEÇA TROMBETA
FENDA PHILIPS ROSCA AGULHA
PERFURANTE DUAS ENTRADAS 3,50 X
25 (1")



102.48.002
PAR DRY FIX CABEÇA TROMBETA
FENDA PHILIPS ROSCA AGULHA
PERFURANTE DUAS ENTRADAS 3,50 X
35 (1.3/8")



102.47.000
PAR DRY FIX CABEÇA FLANGEADA
FENDA PHILIPS ROSCA PONTA AGULHA
PERFURANTE DUAS ENTRADAS
ZINCADO 4,20 X 13 (1/2")



102.32.035
PAR MAD FIX CABEÇA CHATA FENDA
PHILIPS ROSCA SOBERBA ZINCADO 3,8
X 3R\$ 0,0



102.13.002
PORCA SEXTAVADA POLEGADA ROSCA
INTEIRA ROSCA MÁQUINA UNC/BSW
ZINCADA 3/16" UNC 24

Todos os nomes, logotipos de empresas e produtos citados neste catálogo são marcas registradas de suas respectivas corporações. A citação dos mesmos tem a única intenção de auxiliar nossos clientes na identificação de nossos produtos que são compatíveis com os originais.



102.13.003
 PORCA SEXTAVADA POLEGADA ROSCA INTEIRA ROSCA MÁQUINA UNC/BSW ZINCADA 1/4" UNC 20



102.13.004
 PORCA SEXTAVADA POLEGADA ROSCA INTEIRA ROSCA MÁQUINA UNC/BSW ZINCADA 5/16" UNC 18



102.29.058
 PAR CHIP FIX CABEÇA PANELA FENDA PHILIPS ROSCA AUTO CORTANTE BICROMATIZADO 6,00 X 7R\$ 0,0



102.08.003
 PAR MAQ FIX CABEÇA REDONDA FENDA SIMPLES ROSCA MÁQUINA UNC/BSW ZINCADO 1/8" X 1/2"



102.08.005
 PAR MAQ FIX CABEÇA REDONDA FENDA SIMPLES ROSCA MÁQUINA UNC/BSW ZINCADO 1/8" X 3/4"



102.08.007
 PAR MAQ FIX CABEÇA REDONDA FENDA SIMPLES ROSCA MÁQUINA UNC/BSW ZINCADO 1/8" X 1"



102.08.012
 PAR MAQ FIX CABEÇA REDONDA FENDA SIMPLES ROSCA MÁQUINA UNC/BSW ZINCADO 5/32" X 1/4"



102.08.017
 PAR MAQ FIX CABEÇA REDONDA FENDA SIMPLES ROSCA MÁQUINA UNC/BSW ZINCADO 5/32" X 3/4"



102.08.019
 PAR MAQ FIX CABEÇA REDONDA FENDA SIMPLES ROSCA MÁQUINA UNC/BSW ZINCADO 5/32" X 1"



102.08.026
 PAR MAQ FIX CABEÇA REDONDA FENDA SIMPLES ROSCA MÁQUINA UNC/BSW ZINCADO 3/16" X 3/8"



102.08.027
 PAR MAQ FIX CABEÇA REDONDA FENDA SIMPLES ROSCA MÁQUINA UNC/BSW ZINCADO 3/16" X 1/2"



102.08.031
 PAR MAQ FIX CABEÇA REDONDA FENDA SIMPLES ROSCA MÁQUINA UNC/BSW ZINCADO 3/16" X 1"



102.45.010
PAR BROCA FIX SEXTAVADO C ARRUELA
ROSCA BROCA PERFORANTE 5,5 (#12) X
7/8" (22MM)



102.11.002
PAR SEXTAVADO POLEGADA ROSCA
INTEIRA ROSCA MÁQUINA UNC/BSW
ZINCADO 3/16" X 3/4"



102.11.004
PAR SEXTAVADO POLEGADA ROSCA
INTEIRA ROSCA MÁQUINA UNC/BSW
ZINCADO 3/16" X 1"



102.11.009
PAR SEXTAVADO POLEGADA ROSCA
INTEIRA ROSCA MÁQUINA UNC/BSW
ZINCADO 1/4" X 1/2"



102.11.011
PAR SEXTAVADO POLEGADA ROSCA
INTEIRA ROSCA MÁQUINA UNC/BSW
ZINCADO 1/4" X 3/4"



102.11.026
PAR SEXTAVADO POLEGADA ROSCA
INTEIRA ROSCA MÁQUINA UNC/BSW
ZINCADO 5/16" X 1/2"



102.11.027
PAR SEXTAVADO POLEGADA ROSCA
INTEIRA ROSCA MÁQUINA UNC/BSW
ZINCADO 5/16" X 5/8"



102.11.028
PAR SEXTAVADO POLEGADA ROSCA
INTEIRA ROSCA MÁQUINA UNC/BSW
ZINCADO 5/16" X 3/4"



102.17.003
ARRUELA FERRO LISA POLEGADA
ZINCADA 3/16"



102.17.004
ARRUELA FERRO LISA POLEGADA
ZINCADA 1/4"



102.17.005
ARRUELA FERRO LISA POLEGADA
ZINCADA 5/16"



102.49.005
PAR SEXTAVADO ROSCA SOBERBA
ZINCADO 3/16" X 50

Todos os nomes, logotipos de empresas e produtos citados neste catálogo são marcas registradas de suas respectivas corporações. A citação dos mesmos tem a única intenção de auxiliar nossos clientes na identificação de nossos produtos que são compatíveis com os originais.

CARTELA COM 03 PEÇAS

102.49.018
 PAR SEXTAVADO ROSCA SOBERBA ZINCADO 1/4" X 65

CARTELA COM 10 PEÇAS

102.32.005
 PAR MAD FIX CABEÇA CHATA FENDA PHILIPS ROSCA SOBERBA ZINCADO 2,50 X 22 (1")

CARTELA COM 18 PEÇAS

102.32.008
 PAR MAD FIX CABEÇA CHATA FENDA PHILIPS ROSCA SOBERBA ZINCADO 2,80 X 16 (5/8")

CARTELA COM 10 PEÇAS

102.32.018
 PAR MAD FIX CABEÇA CHATA FENDA PHILIPS ROSCA SOBERBA ZINCADO 3,20 X 22 (1")

CARTELA COM 10 PEÇAS

102.32.027
 PAR MAD FIX CABEÇA CHATA FENDA PHILIPS ROSCA SOBERBA ZINCADO 3,50 X 3R\$ 0,0

CARTELA COM 10 PEÇAS

102.32.036
 PAR MAD FIX CABEÇA CHATA FENDA PHILIPS ROSCA SOBERBA ZINCADO 3,8 X 40 (1.1/2")

CARTELA COM 07 PEÇAS

102.32.044
 PAR MAD FIX CABEÇA CHATA FENDA PHILIPS ROSCA SOBERBA ZINCADO 4,20 X 40 (1.1/2")

CARTELA COM 06 PEÇAS

102.32.066
 PAR MAD FIX CABEÇA CHATA FENDA PHILIPS ROSCA SOBERBA ZINCADO 4,80 X 40 (1.1/2")

CARTELA COM 06 PEÇAS

102.32.068
 PAR MAD FIX CABEÇA CHATA FENDA PHILIPS ROSCA SOBERBA ZINCADO 4,80 X 50 (2")

CARTELA COM 04 PEÇAS

102.32.094
 PAR MAD FIX CABEÇA CHATA FENDA PHILIPS ROSCA SOBERBA ZINCADO 6,10 X 65,0

CARTELA COM 20 PEÇAS

102.13.001
 PORCA SEXTAVADA POLEGADA ROSCA INTEIRA ROSCA MÁQUINA UNC/BSW ZINCADA 5/32" UNC 32

CARTELA COM 03 PEÇAS

102.49.031
 PAR SEXTAVADO ROSCA SOBERBA ZINCADO 5/16" X 65



102.99.000
PAR MAQ FIX CABEÇA REDONDA FENDA
SIMPLES ROSCA MÁQUINA UNC/BSW
ZINCADO 5/32" X 1/4" (6,5MM) C
PORCAS



102.99.001
PAR MAQ FIX CABEÇA REDONDA FENDA
SIMPLES ROSCA MÁQUINA UNC/BSW
ZINCADO 5/32" X 1" C PORCAS



102.99.002
PAR MAQ FIX CABEÇA REDONDA FENDA
SIMPLES ROSCA MÁQUINA UNC/BSW
ZINCADO 3/16" X 3/8" C PORCAS



102.99.003
PAR SEXTAVADO POLEGADA ROSCA
INTEIRA ROSCA MÁQUINA UNC/BSW
ZINCADO 1/4" X 1/2" (13MM) C PORCAS



102.99.004
PAR SEXTAVADO POLEGADA ROSCA
INTEIRA ROSCA MÁQUINA UNC/BSW
ZINCADO 1/4" X 3/4" C PORCAS



102.99.005
PAR SEXTAVADO POLEGADA ROSCA
INTEIRA ROSCA MÁQUINA UNC/BSW
ZINCADO 3/16" X 3/4"



102.99.006
PAR SEXTAVADO POLEGADA ROSCA
INTEIRA ROSCA MÁQUINA UNC/BSW
ZINCADO 5/16" X 5/8"



102.99.007
PAR SEXTAVADO POLEGADA ROSCA
INTEIRA ROSCA MÁQUINA UNC/BSW
ZINCADO 5/16" X 1/2" (13MM)



102.99.008
PAR SEXTAVADO POLEGADA ROSCA
INTEIRA ROSCA MÁQUINA UNC/BSW
ZINCADO 5/16" X 3/4"



102.52.009
BUCHA FIX
PLÁST. M6



102.52.011
BUCHA FIX
PLÁST. M8



102.52.012
BUCHA FIX
PLÁST. M10

Todos os nomes, logotipos de empresas e produtos citados neste catálogo são marcas registradas de suas respectivas corporações. A citação dos mesmos tem a única intenção de auxiliar nossos clientes na identificação de nossos produtos que são compatíveis com os originais.



MALHA DESSOLDADORA 1,5MM
16.26.001 - 2,0MM
16.26.000 - 2,5MM



16.26.002
MALHA DESSOLDADORA
2,0 MM X 1,5 M



FITA ISOLANTE
16.11.017 10MTS.....
16.11.018 20MTS.....



18.13.009
DISPENSER PARA ÁLCOOL OU FLUXO



FLUXO AUTO LIMPANTE 100ML
MOD. CX-51 E CX-56
16.13.000 - ALTA OXIDAÇÃO
16.13.001 - BAIXA OXIDAÇÃO

16.14.019
LUBRIFICANTE
GRAFITE EM PÓ 25GR



GRAXA SILICONE POTE
16.14.000 10G



16.14.001 50G

16.14.007 100G

18.06.002
MULTÍMETRO ANALÓGICO 360R
PRECISÃO FUNÇÕES BÁSICAS RANGE
ACESSÓRIOS: PONTA DE PROVA , BATERIA
ALIMENTAÇÃO : BATERIA 3V (AAA) X 3
(3%) + 1 CORRENTE AC DC 50U/2.5M/25M/250M
(3%) + 1 RESISTÊNCIA X1/ X 10/1K /10K
(4%) + 1 TENSÃO AC 10/50/250/1000V
(3%) + 1 TENSÃO DC 100M/500M/2.5/10/50/250/1000V



18.06.001
MULTÍMETRO ANALÓGICO 1000
PRECISÃO FUNÇÕES BÁSICAS RANGE
ACESSÓRIOS: PONTA DE PROVA , BATERIA
ALIMENTAÇÃO : R06 (1,5V) X 2
(5%) + 1 CORRENTE AC DC 0.5M/50/500A
DB 10DB + 22DB
(5%) + 1 RESISTÊNCIA X 10/100X 1KW
(5%) + 1 TENSÃO AC 10/50/250/1000V
(5%) + 1 TENSÃO DC 108508/250/1000V



18.06.016
MULTÍMETRO DIGITAL DT 830B CAIXA



MÚLTIPLO 6 PÇS

CONSULTE PREÇO PARA QUANTIDADE

16.13.007
FLUXO DAXXIA NO-CLEAN 300ML

18.06.000
 MULTÍMETRO DIGITAL DT 830B
 PRECISÃO FUNÇÕES BÁSICAS RANGE
 ACESSÓRIOS: PONTA DE PROVA , MANUAL
 ALIMENTAÇÃO : BATERIA 9V (1%) + 2 CORRENTE AC DC
 200UA/2000UA/20MA/200MA/10A
 DIODO: OK
 DISPLAY MÁX 1999
 IMPEDÂNCIA DE ENTRADA PARA MEDIÇÃO DA TENSÃO 1M
 INDICADOR DE BATERIA FRACA: OK
 (0,8%) + 2 RESISTÊNCIA 200 R/2K/200K/2M
 (2%) + 2 TENSÃO AC 200/750V
 (0,5%) + 2 TENSÃO DC 200MV/2/20/200/1000V
 TRANSISTOR: OK



18.06.018
 MULTÍMETRO
 DIGITAL DT 832



18.06.010
 ALICATE AMPERÍMETRO
 DIGITAL 266C

18.06.011
 ALICATE AMPERÍMETRO
 DIGITAL 266



18.06.012
 MULTÍMETRO DIGITAL DT9205



18.06.013
 MUTIMETRO DIGITAL UT30B GOLDEN



18.06.015
 MULTÍMETRO DIGITAL C/TESTE DE
 CABO DE REDE HY7300



PASTA TÉRMICA
 16.18.002 10G - BISNAGA
 16.18.001 50G - BISNAGA
 16.18.000 15G - POTE



PASTA TÉRMICA CDA
 16.18.014 POTE 60GRS
 16.18.015 POTE 120GRS
 16.18.013 BISNAGA 10GRS ...



16.18.017
 PASTA PARA SOLDA 110G



16.18.009
 PASTA TÉRMICA THERMAL SILVER
 5G BLISTER



16.18.016
 PASTA TÉRMICA
 7G BLISTER



16.13.002
 FLUXO PASTOSO 30GRS

Todos os nomes, logotipos de empresas e produtos citados neste catálogo são marcas registradas de suas respectivas corporações. A citação dos mesmos tem a única intenção de auxiliar nossos clientes na identificação de nossos produtos que são compatíveis com os originais.

daxxia
 PERCLORETO DE FERRO SOLUÇÃO
 16.19.007 - 100ML
 16.19.008 - 250ML
 16.19.009 - 500ML
 16.19.010 - 1LITRO



16.19.006
 PERCLORETO 200GS



BANANA PB 086 (MIN. 10 PÇS)
 12.13.011 - AM
 12.13.012 - AZ
 12.13.013 - VD
 12.13.014 - PT
 12.13.015 - VM



18.09.018
 PONTA DE PROVA 90° 0,8M JR 9210



18.09.022
 PONTA DE PROVA PARA DT830 50CM



18.09.019
 PONTA DE PROVA CINZA C/ PROTETOR PONTEIRA



18.09.023
 PONTA DE PROVA PONTA AGULHA



BANANA MINI PB 066 (MIN. 10 PÇS)
 12.13.006 - AM 12.13.008 - PT
 12.13.007 - AZ 12.13.009 - VD
 12.13.010 - VM



12.13.016
 PLUG BANANA IMP. GROSSO PRETO/VERMELHO (PAR)



12.13.017
 PLUG BANANA IMP. FINO PRETO/VERMELHO (PAR)



PONTA DE PROVA AVULSA PT 0952
 18.09.000 - COR PRT
 18.09.001 - COR VRM



18.09.024
 PONTA DE PROVA IMP. PRETA/VERMELHO (PAR)



PONTA DE PROVA AVULSA PT 0953
 18.09.002 - COR PRT
 18.09.003 - COR VRM



PONTA DE PROVA AVULSA PT 0958
 18.09.004 - COR PRT
 18.09.005 - COR VRM



18.09.025
 PONTA DE PROVA IMP. PRETA/VERMELHO (PAR)



PONTA DE PROVA PINO FINO
 18.09.006 - MOD.5262



18.09.008
 PONTA DE PROVA PINO FINO PP 58162 BBS



18.09.011
 PONTA DE PROVA PINO GROSSO 90° - MOD.5290



18.09.012
 PONTA DE PROVA PINO GROSSO - MOD.5285

18.09.007 - MOD.5362



18.09.013
PONTA DE PROVA PINO GROSSO -
MOD.5286



18.09.014
PONTA DE PROVA PINO GROSSO -
MOD.5385



18.09.015
PONTA DE PROVA PINO GROSSO
MOD.5386



18.09.016
PONTA DE PROVA PINO GROSSO PP
58165 BBS



18.09.017
PONTA DE PROVA RETA 0,8M JR 9212



18.09.020
PONTA DE PROVA DS814



18.09.021
PONTA DE PROVA DS 813



18.12.013
BICO SILICONE P/
SUGADOR SOLDA SS 1F/
SS 15F



18.12.014
BICO SEMI RIGIDO P/
SUGADOR SOLDA
SS 15



18.12.015
BICO SEMI RIGIDO P/
SUGADOR SOLDA
BGR 20N



18.12.016
BICO SILICONE P/
SUGADOR SOLDA SS
20F/SBG 10F



18.12.017
ANEL O'RING P/
SUGADOR SOLDA AO 22
P SS 15/SS 15F



18.12.018
ANEL O'RING P/
SUGADOR SOLDA AO 16
P SS 20/SBG10



SOLDA EM FIO DS AZUL 60X40 CARRETEL
16.21.016 - 1,0MM 200GR
16.21.017 - 1,0MM 100GR



SOLDA EM FIO DS CORAL 63X37 CARRETEL
16.21.018 - 0,5MM 200GR
16.21.019 - 0,5MM 100GR
16.21.020 - 0,8MM 200GR
16.21.021 - 0,8MM 100GR



16.21.022
SOLDA EM FIO DS 1,0MM VERDE 100GR 99% SN
0,3%AG X 0,7% CU LED FREE - SEM CHUMBO



16.21.023
SOLDA CAST 2MM



16.21.000
SOLDA AZUL 60 X 40 CARRETEL
1,0MM X 250 GR



16.21.001
SOLDA AZUL 60 X 40 CARRETEL
1,0MM X 500 GR



16.21.005
SOLDA MARROM 25 X 75 1.5M
CARRETEL 500G

Todos os nomes, logotipos de empresas e produtos citados neste catálogo são marcas registradas de suas respectivas corporações. A citação dos mesmos tem a única intenção de auxiliar nossos clientes na identificação de nossos produtos que são compatíveis com os originais.



16.21.002
SOLDA AZUL 60 X 40 TUBINHO
1MM X 22 GR



TUBINHO DE SOLDA 63 X 37 0,5MM
16.21.009 - 0,5MM
16.21.010 - 0,8MM



16.21.003
SOLDA CORAL 63 X 37 CARRETEL
0,5MM X 250 GR



16.21.004
SOLDA CORAL 63 X 37 CARRETEL
1MM X 500 GR



16.21.013
POTE COM 100 PEÇAS



16.21.012
CARTELA DE SOLDA 60 X 40



16.21.006
SOLDA 189MSX10 - AZUL 500GR



16.21.007
SOLDA 189MSX10 - 125GR



16.21.008
SOLDA 1 MM AZUL TUBINHO



16.09.004
MALHA DESSOLDADORA
WELLER 2MM X 30M



18.12.025
SUGADOR DE SOLDA PLÁSTICO DS-205
ESD



18.12.024
SUGADOR PLÁSTICO ZD-208



18.12.023
SUGADOR SOLDA METÁLICO



18.12.001
SUGADOR DE SOLDA PLÁSTICO SS 1F



18.12.019
SUGADOR DE SOLDA PLÁSTICO



18.13.003
ESPONJA VEGETAL C 2 UNID EV-UN2



18.13.002
SUPORTE FERRO DE SOLDA

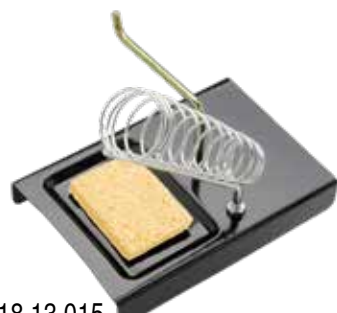

18.13.015
SUPORTE P/ FERRO DE SOLDA E
CARRETEL



18.13.016
SUPORTE P/ FERRO DE SOLDA



18.13.005
SUPORTE CARRETEL DE SOLDA



18.13.006
SUPPORTO FERRO E CARRETEL DE SOLDA



18.13.007
SUPPORTO PARA CARRETEL DE SOLDA



18.13.013
SUPPORTO P/ FERRO C/ ESPONJA METÁLICA



18.13.011
PERFURADOR DE PLACA FAZ FURO 1MM



29.06.056
SUPPORTO P AUXÍLIO MONTAGEM PCI SP 1



18.13.008
ESPONJA METÁLICA

USADA EM ESTACÃO DE SOLDA



PONTA P/ FERRO DE SOLDA OCA
18.10.000 - 30W (IMPORTADO)
18.10.003 - 40W (IMPORTADO)



Eda



PREÇO ESPECIAL DE LANÇAMENTO!

FERRO DE SOLDA
18.05.031 - 30W 127V EDA

18.05.032 - 40W 127V EDA

18.05.033 - 60W 127V EDA

18.05.034 - 30W 220V EDA

18.05.035 - 40W 220V EDA

18.05.036 - 60W 220V EDA



PONTA P/ FERRO DE SOLDA CÔNICA HIKARI PLUS/POWER

- 18.10.008 - 30W
- 18.10.009 - 40W
- 18.10.010 - 60W

PREÇO UNITÁRIO

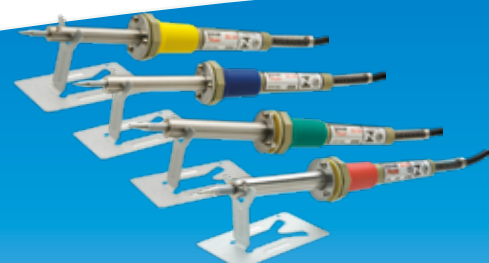

FERRO SOLDAR HIKARI PLUS SC50 P (BLITER)

- 18.05.009 25W = 30W - 110V
- 18.05.010 25W = 30W - 220V
- 18.05.011 34W = 40W - 110V
- 18.05.012 34W = 40W - 220V
- 18.05.021 42W = 50W - 110V
- 18.05.022 42W = 50W - 220V
- 18.05.013 50W = 60W - 110V
- 18.05.014 50W = 60W - 220V

HIKARI

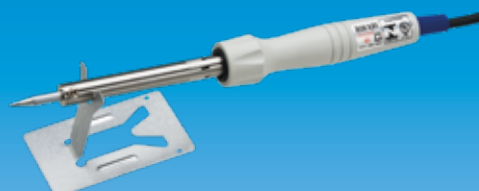

HIKARI POWER

- 18.05.025 30W - 110V
- 18.05.026 30W - 220V
- 18.05.027 40W - 110V
- 18.05.028 40W - 220V
- 18.05.029 60W - 110V
- 18.05.030 60W - 220V

FERRO DE SOLDA



PISTOLA DE SOLDAR HIKARI FIRE

- 18.05.023 100/127V
- 18.05.024 100/220V



29.06.015
PLACA COMPLETA TV SAMSUNG 52" IP. 351135A / BN 4400184A MOD. LNT-5271F/
LNT5271FX/XAA

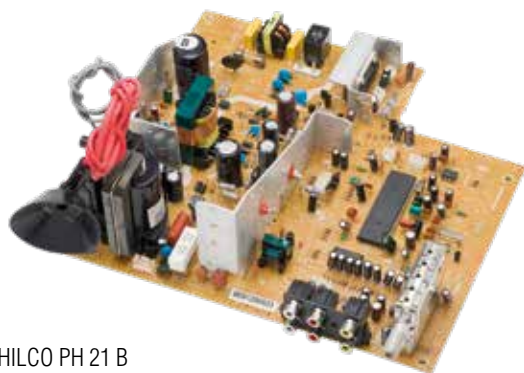

29.06.195
PLACA TV PHILCO PH 21 B

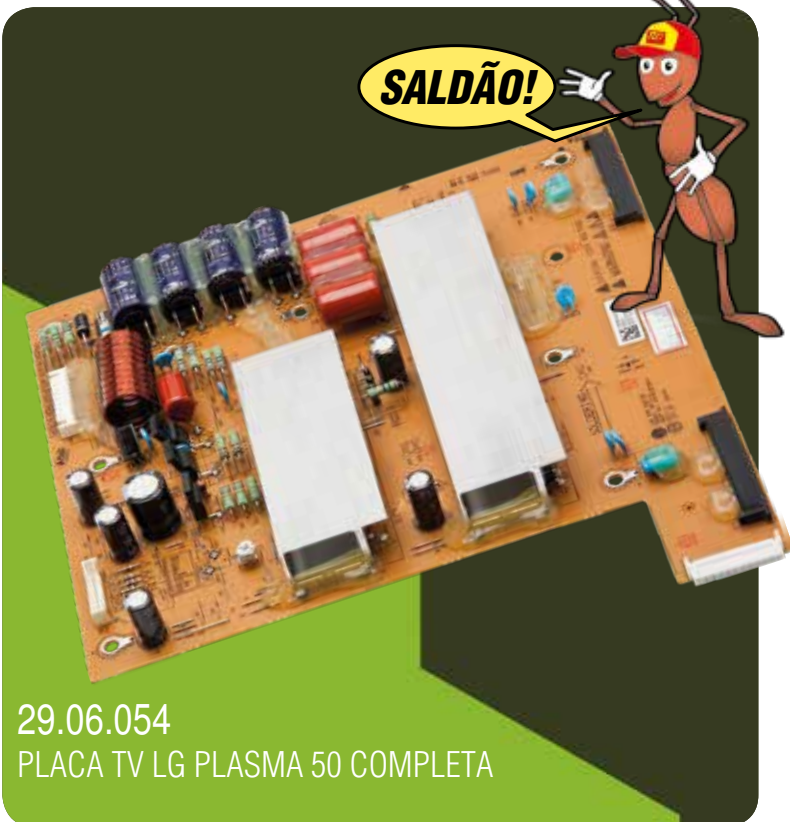

29.06.054
PLACA TV LG PLASMA 50 COMPLETA



Barra Sindal



33.00.001
12X 4MM H3 A



33.00.002
12X 6MM H5 A



33.00.003
12X 10MM H10 A



33.00.007
12X 12MM H15 A



33.00.008
12X 14MM H20 A



33.00.006
12X 16MM H30 A

Resistência para Chuveiro



RESISTÊNCIA DUCHA C
38.05.001 - 127V
38.05.002 - 220V



RESISTÊNCIA DUCHA F
38.05.003 - 127V
38.05.004 - 220V



RESISTÊNCIA DUCHA L 4000W
38.05.005 - 127V
38.05.006 - 220V



RESISTÊNCIA DUCHA L 5400W
38.05.007 - 127V
38.05.008 - 220V

**CAPACITORES
POLIPROPILENO**
VEJA NA PÁGINA 162



Todos os nomes, logotipos de empresas e produtos citados neste catálogo são marcas registradas de suas respectivas corporações. A citação dos mesmos tem a única intenção de auxiliar nossos clientes na identificação de nossos produtos que são compatíveis com os originais.



24.27.000
ESPELHO COM FURO



24.27.001
ESPELHO CEGO



ESPELHO COM TOMADA
24.27.002 10A.....
24.27.003 20A.....



ESPELHO COM 2 TOMADAS
24.27.004 10A.....
24.27.005 20A.....



ESPELHO INTERRUPTOR
24.27.006 - SIMPLES.....
24.27.007 - PARALELO.....



ESPELHO C/ 2 INTERRUPTORES
24.27.008 SIMPLES.....
24.27.009 PARALELOS.....



ESPELHO C/ 3 INTERRUPTORES
24.27.010 SIMPLES.....
24.27.011 PARALELOS.....



ESPELHO C/ INTERRUPTOR
SIMPLES + TOMADA
24.27.012 10A.....
24.27.013 20A.....
PARALELO + TOMADA
24.27.014 10A.....
24.27.015 20A.....



ESPELHO C/ 2 INTERRUPTORES
SIMPLES + TOMADA
24.27.016 10A.....
24.27.017 20A.....
PARALELOS + TOMADA
24.27.018 10A.....
24.27.019 20A.....

Tomadas



TOMADA DESM. FÊMEA 2P+T 20A
38.07.270 - BRANCO
38.07.271 - CINZA
38.07.272 - PRETO
38.07.273 - AZUL
38.07.274 - VERMELHO



TOMADA DESM. FÊMEA
38.07.264 - CINZA
38.07.265 - AZUL
38.07.266 - VERMELHO
38.07.267 - PRETO
38.07.268 - BRANCO



TOMADA EXTERNA 2P+T 10A
38.07.288 - BRANCA
38.07.289 - CINZA

Todos os nomes, logotipos de empresas e produtos citados neste catálogo são marcas registradas de suas respectivas corporações. A citação dos mesmos tem a única intenção de auxiliar nossos clientes na identificação de nossos produtos que são compatíveis com os originais.



ADAPTADOR
3 SAÍDAS NBR
38.07.217 - BRANCO
38.07.218 - AZUL
38.07.219 - VERMELHO
38.07.220 - PRETO
38.07.221 - CINZA



ADAPTADOR
3 SAÍDAS 2P+T
38.07.223 - BRANCO
38.07.224 - CINZA
38.07.225 - PRETO
38.07.226 - AZUL
38.07.227 - VERMELHO



ADAPTADOR
3 SAÍDAS RETO
38.07.229 - PRETO
38.07.230 - BRANCO
38.07.231 - CINZA
38.07.232 - AZUL
38.07.233 - VERMELHO



ADAPTADOR
3 SAÍDAS
RETO 2P+T
38.07.235 - BRANCO
38.07.236 - CINZA
38.07.237 - AZUL
38.07.238 - PRETO
38.07.239 - VERMELHO



ADAPTADOR 2P+T
38.07.284 - SORTIDO
38.07.285 - BRANCO



ADAPTADOR 2P
38.07.286 - SORTIDO
38.07.287 - BRANCO



EXTENSÃO PRETA CORDÃO PARALELO
05.10.123 - 3M

05.10.128 - 5M

05.10.133 - 10M

EXTENSÃO PRETA CABO PP
05.10.138 - 3M

05.10.143 - 5M

05.10.148 - 10M

Plug



PLUG 90° PRENSA CABO 2P
38.07.276 - 10A - BRANCO
38.07.278 - 10A - PRETO

38.07.280 - 20A - BRANCO
38.07.282 - 20A - PRETO



PLUG 90° PRENSA CABO 2P+T
38.07.277 - 10A - BRANCO
38.07.279 - 10A - PRETO

38.07.281 - 20A - BRANCO
38.07.283 - 20A - PRETO

PLUG DESM. MACHO 2P+T
38.07.253 - 20A - BRANCO
38.07.254 - 20A - CINZA
38.07.255 - 20A - PRETO
38.07.256 - 20A - VERMELHO

38.07.258 - 10A - BRANCO
38.07.259 - 10A - CINZA
38.07.260 - 10A - PRETO
38.07.261 - 10A - AZUL
38.07.262 - 10A - VERMELHO



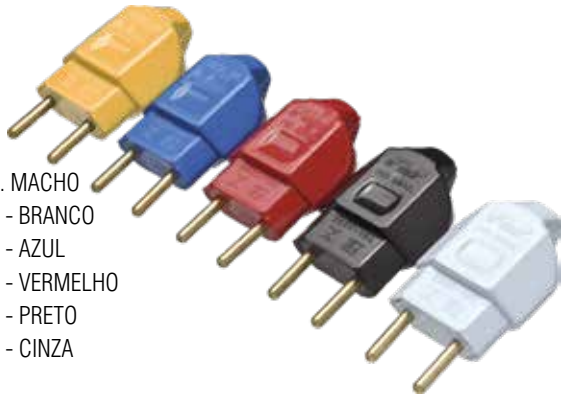

PLUG DESM. MACHO
 38.07.241 - BRANCO
 38.07.242 - AZUL
 38.07.243 - VERMELHO
 38.07.244 - PRETO
 38.07.245 - CINZA

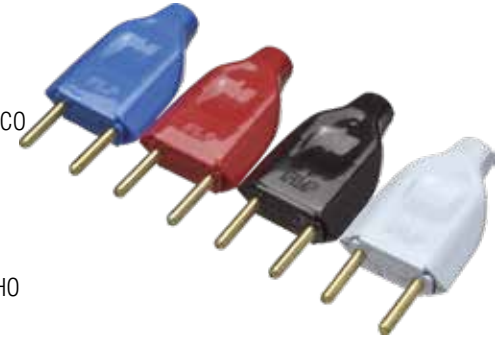

PLUG DESM. MACHO OCO
 38.07.247 - BRANCO
 38.07.248 - CINZA
 38.07.249 - PRETO
 38.07.250 - AZUL
 38.07.251 - VERMELHO

Potes



38.07.209
 POTE ADAPTADOR 2P (15 PÇS)



38.07.211
 POTE ADAPTADOR 2P (36 PÇS)



38.07.210
 POTE ADAPTADOR 2P+T (15 PÇS)



38.07.212
 POTE ADAPTADOR 2P+T (36 PÇS)



38.07.204
 POTE ADAPTADOR 3 SAÍDAS 2P+T (15 PÇS)



38.07.199
 POTE ADAPTADOR 3 SAÍDAS NBR (15 PÇS)



38.07.201
 POTE TOMADA DESM. FÊMEA (40 PÇS)



POTE PLUG 90° PRENSA CABO 2P (30 PÇS)
 38.07.213 - 10A - BRANCO
 38.07.214 - 10A - PRETO

38.07.216 - 20A - BRANCO
 38.07.215 - 20A - PRETO



POTE PLUG 90° PRENSA CABO 2P+T (30 PÇS)
 38.07.290 - 10A - BRANCO
 38.07.292 - 10A - PRETO

38.07.291 - 20A - BRANCO
 38.07.293 - 20A - PRETO

Todos os nomes, logotipos de empresas e produtos citados neste catálogo são marcas registradas de suas respectivas corporações. A citação dos mesmos tem a única intenção de auxiliar nossos clientes na identificação de nossos produtos que são compatíveis com os originais.



38.07.200
POTE PLUG DESM. MACHO (50 PÇS)



POTE PLUG DESM. MACHO 2P+T
(20 PÇS)
38.07.208 - 10A
38.07.207 - 20A



38.07.205
POTE PLUG MACHO OCO SORTIDO
(36 PÇS)



38.07.202
POTE PLUG MACHO PQ (20 PÇS)



38.07.198
POTE SOQUETE PPL (36 PÇS)



38.07.206
POTE TOMADA FÊMEA 2P+T 20A
(15 PÇS)



38.07.203
POTE TOMADA FÊMEA PQ (18 PÇS)

Soquetes



38.16.020
SOQUETE PBT
TIPO PORCELANA



38.16.018
SOQUETE 45°



38.16.021
SOQUETE COM RABICHO



38.16.019
SOQUETE COM RABICHO S/ BUCHA



38.16.017
SOQUETE DE
TETO RETO



38.16.023
SOQUETE PORTA LÂMPADA



38.16.015
SOQUETE SEM
CHAVE



38.16.016
SOQUETE SEM
CHAVE COM BORNE



38.16.022
SOQUETE SEM
CHAVE SEM BUCHA

Diversos



38.16.029
ABRAÇADEIRA PLÁSTICA



38.16.028
SOQUETE FLUOR



LUMINÁRIA MADRI
38.16.026 - BRANCA **38.16.027** - PRETA



PLAFON
38.16.024 - BRANCO **38.16.025** - PRETO



33.01.000
CONECTOR LOUÇA BIPOLAR
10MM - 25A



33.01.001
CONECTOR LOUÇA BIPOLAR
16MM - 50A



33.01.002
CONECTOR LOUÇA TRIPOLAR
10MM - 30A



33.01.003
CONECTOR LOUÇA TRIPOLAR
16MM - 50A

Interruptor e Tomada



38.07.195
INTERRUPTOR SIMPLES DE SOBREPÔR



38.07.189
TOMADA DE SOBREPÔR 10A CINZA



38.07.190
TOMADA DE SOBREPÔR 10A BRANCO

Plug



2 ENTRADA FÊMEA 2 PINOS X 1 SAÍDA MACHO
38.07.002 - BRANCA.....
38.07.003 - PRETA.....



38.07.078
ADAPTADOR 2P CHATO +T X 3P 15A / 250V MECATOOL



ADAPTADOR TRIPOLAR 3 PINOS 10A - 250V
38.07.059 - BRANCA
38.07.079 - PRETA



BENJAMIM
MULTIPLICADOR
10A / 250V QUATRO SAÍDAS
38.07.061 - 2P
38.07.062 - 2P+T



38.07.193
PLUG TRÊS SAÍDAS 2P + T 10A
CINZA



38.07.194
PLUG TRÊS SAÍDAS 2P + T 10A
BRANCO



38.07.191
PLUG TRÊS SAÍDAS 10A CINZA



38.07.192
PLUG TRÊS SAÍDAS 10A BRANCO



19.06.017
TOMADA AC 10A / 250V C/ PORTA
FUSÍVEL 20AG (PEQ) USO DIVERSOS
PAINEL 31,3 X 28,77 Ø3,4MM



19.06.018
TOMADA MACHO TIPO 8



19.06.019
TOMADA A/C PARA CABO TIPO 8

Todos os nomes, logotipos de empresas e produtos citados neste catálogo são marcas registradas de suas respectivas corporações. A citação dos mesmos tem a única intenção de auxiliar nossos clientes na identificação de nossos produtos que são compatíveis com os originais.



38.07.186
TOMADA FÊMEA 2P + T 10A - BRANCO



TOMADA FÊMEA 2P 10A
38.07.187 - CINZA
38.07.188 - BRANCO



38.07.181
PLUGUE MACHO 2P + T 10A / 250V
CINZA



38.07.182
PLUGUE MACHO 2P + T 10A / 250V
BRANCO



38.07.183
PLUGUE MACHO 2P 10A / 250V CINZA



38.07.184
PLUGUE MACHO 2P 10A / 250V BRANCO



PLUG MACHO 2P 90°
38.07.139 10A CINZA.....
38.07.144 10A BRANCO.....
38.07.147 20A BRANCO.....
38.07.148 20A CINZA.....



PLUG MACHO 2P + T 90°
38.07.141 10A CINZA.....
38.07.145 10A PRETO.....
38.07.146 10A BRANCO.....
38.07.149 20A BRANCO.....
38.07.150 20A CINZA.....

PLUG FÊMEA 2P

- 38.07.101 10A PRETO.....
- 38.07.102 10A CINZA.....
- 38.07.103 10A BRANCO.....
- 38.07.104 20A PRETO.....
- 38.07.105 20A CINZA.....
- 38.07.106 20A BRANCO.....
- 38.07.107 10A POTE C/ 50 PEÇAS COLORIDO.....
- 38.07.108 20A POTE C/ 50 PEÇAS COLORIDO.....

PLUG FÊMEA 2P + T

- 38.07.153 10A BRANCO.....
- 38.07.154 10A CINZA.....
- 38.07.155 10A PRETO.....
- 38.07.156 20A BRANCO.....
- 38.07.157 20A CINZA.....
- 38.07.158 20A PRETO.....
- 38.07.129 10A POTE C/ 50 PEÇAS COLORIDO.....
- 38.07.130 20A POTE C/ 50 PEÇAS COLORIDO.....



PLUG MACHO PROFISSIONAL 2P
38.07.159 10A BRANCO.....
38.07.162 20A BRANCO.....
38.07.163 20A CINZA.....
38.07.164 20A PRETO.....

PLUG MACHO PROFISSIONAL 2P + T
38.07.134 10A CINZA.....
38.07.135 10A BRANCO.....
38.07.137 20A CINZA.....
38.07.138 20A BRANCO.....



PLUG MACHO 2P

- 38.07.131** 10A POTE COLORIDO C/ 50 PEÇAS.....
- 38.07.165 10A BRANCO.....
- 38.07.166 10A CINZA.....
- 38.07.167 10A PRETO.....

PLUG MACHO 2P + T

- 38.07.132 10A POTE COLORIDO C/ 50 PEÇAS.....
- 38.07.168 10A BRANCO.....
- 38.07.169 10A CINZA.....
- 38.07.170 10A PRETO.....



38.07.196
PLUGUE TRIÂNGULO CINZA



38.07.197
PLUGUE TRIÂNGULO BRANCO



38.16.000
PLAFON SIMPLES BRANCO - PLÁSTICO



38.16.001
PLAFON DUPLO BRANCO - PLÁSTICO



SPOT SIMPLES - PLÁSTICO
38.16.006 - PRETO
38.16.007 - BRANCO



SPOT DUPLO
38.16.010 - PRETO
38.16.011 - BRANCO



SPOT TRANSLÚCIDO - PLÁSTICO
38.16.008 - PRETO
38.16.009 - BRANCO



SPOT DUPLO TRANSLÚCIDO
38.16.012 - PRETO
38.16.013 - BRANCO



LUMINÁRIA TARTARUGA - PLÁSTICO
38.16.004 - PRETO
38.16.005 - BRANCO



LUMINÁRIA PRISMA - PLÁSTICO
38.16.002 - PRETO
38.16.003 - BRANCO

Filtro de Linha

FILTRO DE LINHA PLÁSTICO PRETO

- 40.00.015 - 3 TOMADAS 40.00.017 - 5 TOMADAS
- 40.00.016 - 4 TOMADAS 40.00.018 - 6 TOMADAS



OFERTA PARA ZERAR ESTOQUE

40.00.001
FILTRO DE LINHA
FLP 3T NOVO
PROTECTOR DE REDE



FILTRO DE LINHA CIRCUIT BREAKER

O CIRCUIT BREAKER É UM CIRCUITO DE PROTEÇÃO QUE ELIMINA A NECESSIDADE DE SUBSTITUIÇÃO DE FUSÍVEL.

SUA FUNÇÃO É PROTEGER O FILTRO E TAMBÉM OS APARELHOS CONECTADOS A ELE.

NO CASO DE SOBRECARGA, CURTO-CIRCUITO OU APARELHOS COM CORRENTE SUPERIOR A CAPACIDADE DO FILTRO, A CHAVE DISJUNTORA É ACIONADA AUTOMATICAMENTE, PROTEGENDO SEU FILTRO E APARELHOS.

APÓS 10 SEGUNDOS, O CONSUMIDOR PODE ACIONAR O "RESET" E UTILIZAR O FILTRO NORMALMENTE.



- 40.00.030 40.00.032
3 TOMADAS 5 TOMADAS
- 40.00.031 40.00.033
4 TOMADAS 6 TOMADAS

Extensão

05.10.118
EXTENSÃO REDONDA
2X0,75MM 5 METROS



EXTENSÃO MACHO/FÊMEA
2X0,75MM
05.10.119 - 3 M



05.10.120 - 5 M

EXTENSÃO LINEAR
05.10.121 - 3M

05.10.122 - 5M



REFLETORES LED

IP65
PRÓPRIO PARA USO EXTERNO

100-240V
Multivolt

Vida útil
30.000h

GARANTIA
2
ANOS

70W
5600lm



70W
Dimensões: 284x298x67mm

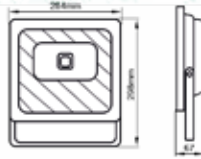

100W
8000lm



100W
Dimensões: 290x377x78mm

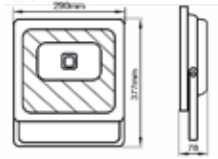

OFERTA PARA ZERAR ESTOQUE

CÓDIGO	Potência	Lúmens	Temp.Cor	Angulo	Dimerizável
38.19.134	70W	5600lm	6.500K	120°	Não

CÓDIGO	Potência	Lúmens	Temp.Cor	Angulo	Dimerizável
38.19.135	100W	8000lm	6.500K	120°	Não

TUBOLED T8

9W
1035lm

18W
2070lm

100-240V
Multivolt

GARANTIA
3
ANOS

Vida útil
25.000h



MÚLTIPLO 4 PEÇAS



Dimensões: \varnothing 28x600mm
9W

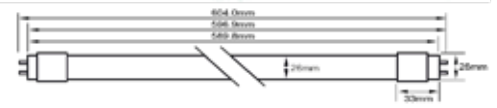

Dimensões: \varnothing 28x1200mm
18W

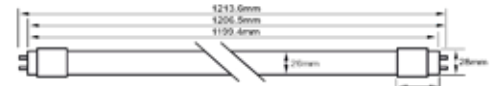

OFERTA PARA ZERAR ESTOQUE

SYLVANIA
by OL ILUMINAÇÃO

CÓDIGO	Base	Potência	Lúmens	Temp.Cor	Dimerizável
38.19.142	G13	9W	1035lm	3000K	Não
38.19.143	G13	9W	1035lm	4000K	Não
38.19.144	G13	9W	1035lm	6500K	Não
38.19.145	G13	18W	2070lm	3000K	Não
38.19.146	G13	18W	2070lm	4000K	Não
38.19.147	G13	18W	2070lm	6500K	Não

BULBO LED A60



GARANTIA
3
ANOS

7W
700lm

9W
900lm



100-240V
Multivolt

Dimensões
Ø60x108mm



CÓDIGO	Base	Potência	Tensão	Lúmens	Temp.Cor	Vida Útil	Dimerizável
38.19.020	E27	4W	Multivolt	700lm	2.700K	25.000h	Não
38.19.021	E27	4W	Multivolt	700lm	6.500K	25.000h	Não
38.19.023	E27	7W	Multivolt	700lm	6.500K	25.000h	Não

SPOT LED



OFERTA PARA
ZERAR
ESTOQUE

5W
400lm

Dimensões:
90X90X41mm

GARANTIA
3
ANOS

Vida útil
25.000h

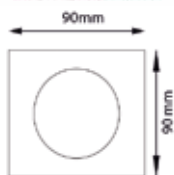

5W
400lm

Dimensões:
Ø90X41mm

GARANTIA
3
ANOS

Vida útil
25.000h

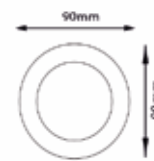

CÓDIGO	Potência	Tensão	Lúmens	Temp.Cor	Dimerizável
38.19.111	5W	Multivolt	400lm	3.000K	Não

CÓDIGO	Potência	Tensão	Lúmens	Temp.Cor	Dimerizável
38.19.114	5W	Multivolt	400lm	6.500K	Não
38.19.113	5W	Multivolt	400lm	3.000K	Não

LUMINÁRIA INSTALED



OFERTA PARA
ZERAR
ESTOQUE

16W
1280lm

32W
2560lm

GARANTIA
2
ANOS

100-240V
Multivolt
Vida útil
30.000h

Dimensões:
625X146x46mm

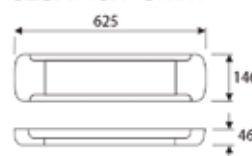

1222x146x46mm

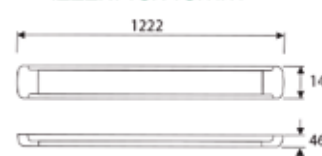

CÓDIGO	Potência	Tensão	Lúmens	Temp.Cor	Dimerizável
38.19.103	16W	Multivolt	1280lm	6.500K	Não
38.19.104	32W	Multivolt	2560lm	6.500K	Não

Todos os nomes, logotipos de empresas e produtos citados neste catálogo são marcas registradas de suas respectivas corporações. A citação dos mesmos tem a única intenção de auxiliar nossos clientes na identificação de nossos produtos que são compatíveis com os originais.



POT ROT 24MM S/ CHAVE
EIXO METÁLICO 40MM
23.06.000 - 1K
23.06.001 - 5K
23.06.002 - 10K
23.06.003 - 20K
23.06.004 - 50K
23.06.005 - 100K
23.06.006 - 200K
23.06.007 - 500K
23.06.008 - 1MB



POTENCIÔMETRO
SIMPLES L20 EIXO
EXTRIADO 3 TERMINAIS
23.04.015 - 1KB
23.04.016 - 2KB
23.04.000 - 5KB
23.04.001 - 10KB
23.04.017 - 20KB
23.04.002 - 50KB
23.04.003 - 100KB
23.04.018 - 200KB
23.04.043 - 500KB

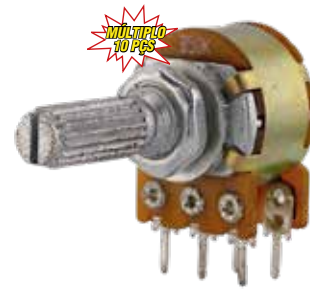

POT. DUPLO L15 EIXO
ESTRIADO 6 TERM.
WH148
23.04.021 - 5KB
23.04.022 - 10KB
23.04.023 - 20KB
23.04.024 - 50KB
23.04.025 - 100KB

POT. DUPLO L20 EIXO
ESTRIADO 6 TERM.
WH148
23.04.028 - 1KB
23.04.029 - 2KB
23.04.030 - 5KB
23.04.031 - 10KB
23.04.032 - 20KB
23.04.033 - 50KB
23.04.034 - 100KB
23.04.035 - 200KB
23.04.036 - 500KB
23.04.037 - 1M



POT. SIMPLES L15 EIXO
ESTRIADO 3 TERM. WH148
23.04.006 - 1KB
23.04.008 - 5KB
23.04.009 - 10KB
23.04.010 - 20KB
23.04.011 - 50KB
23.04.012 - 100KB
23.04.013 - 200KB
23.04.041 - 220KB
23.04.014 - 500KB
23.04.042 - 1 M

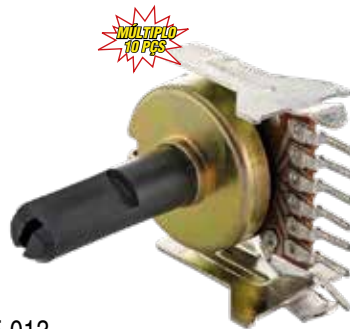

23.15.013
CARB C/ TAP 100KB



POTENC. ROT PRECISÃO 3590S
23.35.000 - 1K
23.35.001 - 2K
23.35.002 - 5K



POTENCIÔMETRO DE FIO
23.24.000 - 30R
23.24.001 - 50R
23.24.002 - 100R
23.24.004 - 500R
23.24.005 - 1K
23.24.010 - 2K
23.24.007 - 5K
23.24.008 - 10K

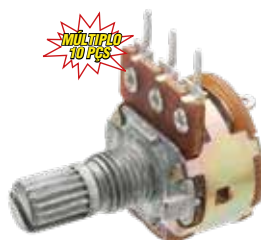

POTENCIÔMETRO SIMPLES L16
C/ CHAVE
23.04.044 - 220K
23.04.045 - 200K



POT. ROTATIVO 16MM
1ª LINHA EIXO RECARTEILHADO C/ CHAVE
23.04.048 - 10KD
23.04.049 - 50KD
23.04.050 - 10KB
23.04.051 - 50KB
23.04.052 - 100KB
23.04.053 - 200KB



EIXO MEIA CANA
C/ CHAVE
23.04.046 - 10KD
23.04.047 - 50KD



23.05.008
POT. ENCODER P/MESA BEHRINGER

POTENCIÔMETRO ROTATIVO
9MM CORPOX25MM EIXO
MESA MACKIE E OUTRAS
23.05.000 - 5KA
23.05.001 - 5KB
23.05.002 - 5KC
23.05.003 - 10KB
23.05.004 - 50KB



POTENCIÔMETRO ROTATIVO
11MM CORPOX25MM EIXO
23.05.005 - 5KB
23.05.006 - 10KB
23.05.007 - 50KB

23.07.000
POT PIONNER
YSD5010A



23.04.055
POT ROTATIVO DE
VOLUME HBUSTER
SOLDA PLACA SMD



32.17.040
KNOB ROT PLÁSTICO
PIONNER YXA5350-FS





23.04.039
POT ROT 1M S/CHAVE L20



23.15.003
POT ROT 100KB ST SIMPLS
C/ SUP 7 TERM



23.15.012
POT ROT 50KB ST SIMPLS
C/ SUP 7 TERM

POTENCIÔMETRO DESLIZANTE 60MM X 73MM

(PERCURSO X COMPRIMENTO)



23.30.003
10KAX2 STEREO EIXO METÁLICO -
YAMAHA - BEHRINGER E OUTROS



23.30.004
20KAX2 STEREO EIXO METÁLICO -
YAMAHA - BEHRINGER E OUTROS



23.30.005
50KAX2 STEREO EIXO METÁLICO -
YAMAHA - BEHRINGER E OUTROS



23.30.007
10KAX2 STEREO EIXO METÁLICO
DIVERSAS MESAS DE SOM

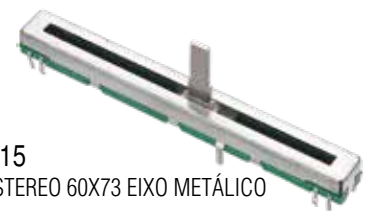

23.30.015
10KAX2 STEREO 60X73 EIXO METÁLICO



23.30.006
10KBX2 STEREO EIXO T METÁLICO 60MM X 88MM

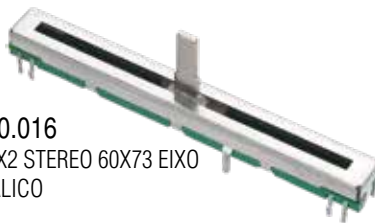

23.30.016
10KBX2 STEREO 60X73 EIXO
METÁLICO



23.30.013
100KBX2 STEREO EIXO LARGO
METÁLICO 45MM X 73MM

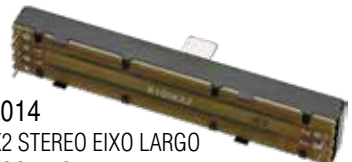

23.30.014
100KBX2 STEREO EIXO LARGO
METÁLICO MESA DE LUZ 60MM X 88MM



23.32.025
10KA MONO EIXO METÁLICO
100MM X 125MM



23.32.020
10KA MONO EIXO LARGO
METÁLICO 100MM X 125MM



23.30.008
10KAX2 STEREO EIXO LARGO
METÁLICO 100MM X 125MM

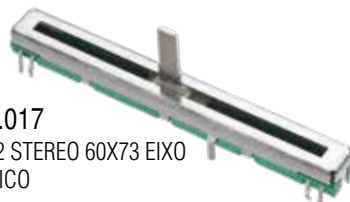

23.30.017
50KAX2 STEREO 60X73 EIXO
METÁLICO



23.32.003
10KB MONO EIXO METÁLICO -
MESA LUZ DIVERSAS E OUTROS



POTENCIÔMETRO DESLIZANTE
60MM X 88MM MONO EIXO METÁLICO



POTENCIÔMETRO DESLIZANTE
60MM X 88MM EIXO LARGO METÁLICO
23.32.021 10KA MONO
23.30.009 10KAX2 STEREO



POTENCIÔMETRO MONO
EIXO METÁLICO DIVERSAS
MESAS DE SOM
23.32.017 - 10KA
23.32.018 - 10KB
23.32.019 - 50KB

- 23.32.011 - 10KA
- 23.32.012 - 10KB
- 23.32.013 - 20KB
- 23.32.014 - 50KB
- 23.32.015 - 100KB
- 23.32.016 - 200KB

POTENCIÔMETRO DESLIZANTE 30MM X 45MM

(PERCURSO X COMPRIMENTO)



23.30.001
10KAX2 STEREO EIXO METÁLICO -
DIVERSAS MESAS DE SOM



23.30.002
10KBX2 STEREO EIXO METÁLICO -
DIVERSAS MESAS DE LUZ



POTENCIÔMETRO DESLIZANTE
30MM X 45MM

23.32.022 - 20KA MONO EIXO MET.
23.32.023 - 50KA MONO EIXO MET.
23.32.024 - 10KB MONO EIXO MET.



23.32.000
10KA MONO EIXO METÁLICO - MESAS
MACKIE E OUTROS



23.33.000
20KA MONO EIXO PLÁSTICO - MESAS
CICLOTRON E OUTROS



23.33.001
20KA MONO EIXO PLÁSTICO -
CICLOTRON PINO INVERTIDO

POTENCIÔMETRO DESLIZANTE 45MM X 60MM

(PERCURSO X COMPRIMENTO)



23.31.000
20KAX2 STEREO EIXO PLÁSTICO -
MESAS STANER E OUTROS



23.31.001
10KAX2 STEREO EIXO PLÁSTICO -
MESAS STANER E OUTROS



23.32.001
10KA MONO EIXO METÁLICO -
MESAS MACKIE E OUTROS



23.33.002
10KA MONO EIXO PLÁSTICO -
MESAS STANER E OUTROS



23.33.003
20KA MONO EIXO PLÁSTICO -
MESAS STANER E OUTROS



23.33.004
10KB MONO EIXO PLÁSTICO -
MESAS DE LUZ DIVERSAS



23.33.005
100KB MONO EIXO PLÁSTICO -
MESAS DE LUZ DIVERSAS

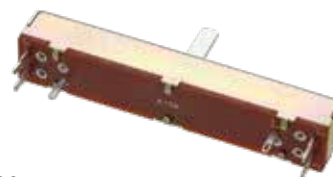

POTENCIÔMETRO DESLIZANTE EIXO METÁLICO 45MM X 73MM

23.30.010 10KAX2 STEREO MIXER GEMINI

23.30.011 50KAX2 STEREO MIXER GEMINI

23.30.012 100KBX2 STEREO MIXER GEMINI

23.32.006 10KB MONO

23.32.007 20KB MONO

23.32.008 50KB MONO

23.32.009 100KB MONO

23.32.010 200KB MONO



23.30.018
POT DESLIZANTE 100KB 16MM X 12MM



23.32.005
10KA MONO EIXO LARGO BEHRINGER



WWW.TNDELETRONICA.COM.BR

LEIA NA PÁGINA 1 DO
CATÁLOGO SOBRE NOSSA
POLÍTICA DE VENDA,
TROCA E GARANTIA

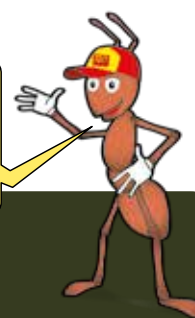

Todos os nomes, logotipos de empresas e produtos citados neste catálogo são marcas registradas de suas respectivas corporações. A citação dos mesmos tem a única intenção de auxiliar nossos clientes na identificação de nossos produtos que são compatíveis com os originais.



ARANDELA RETANGULAR

- ARANDELA PARA EMBUTIR EM FORRO.
- ELEGÂNCIA E FINO ACABAMENTO.
- ALTO FALANTE DE 6 POLEGADAS COM SUSPENSÃO E TWEETER DE 2 POLEGADAS.
- ACABAMENTO (FUNDO) BRANCO OU PRETO.
- CORPO INJETADO EM ABS.
- PESO 925G OU 1,7 KG.
- DIMENSÕES: 22 X 30,5 X 8CM (L X C X P).

BRANCA

- 01.43.000 - 94WMUSICAL - 47WRMS
- 01.43.007 - 130WMUSICAL - 65WRMS
- 01.43.008 - 160WMUSICAL - 80WRMS



ARANDELA REDONDA

- ARANDELA PARA EMBUTIR EM FORRO.
- PRATICIDADE E FÁCIL INSTALAÇÃO.
- ALTO FALANTE DE 5 E 6 POLEGADAS FULL RANGE OU COAXIAL.
- COR BRANCA.
- CORPO INJETADO EM ABS.
- PESO 650G OU 850G.
- DIMENSÕES: 23,7CM (DIAM.) X 7CM (PROFUND.)

- 01.43.009 5" 27W RMS (FULL RANGE)
- 01.43.004 6" 27W RMS (FULL RANGE)
- 01.43.003 6" 34W RMS (COAXIAL)

FORTÍSSIMO, O MELHOR CUSTO BENEFÍCIO EM SOM AMBIENTE.



DSK

CAIXA ACÚSTICA PARA SOM AMBIENTE

- CAIXA ACÚSTICA: 65W
- CORES: BRANCO OU PRETO
- CAIXA ACÚSTICA 2 VIAS
- ALTO FALANTE DE 4 POLEGADAS COM SUSPENSÃO
- TWEETER DE 2 POLEGADAS
- PROPORCIONA MELHOR DISTRIBUIÇÃO DO SOM.
- DIMENSÕES: 11,5 X 18 X 11,5CM (L X A X P)
- AS POTÊNCIAS DESCRITAS SÃO DADAS EM POTÊNCIA MUSICAL. PARA SE OBTER POTÊNCIA EM RMS DIVIDIR POR 2.

24.01.002 - BRANCA

24.01.001 - PRETA

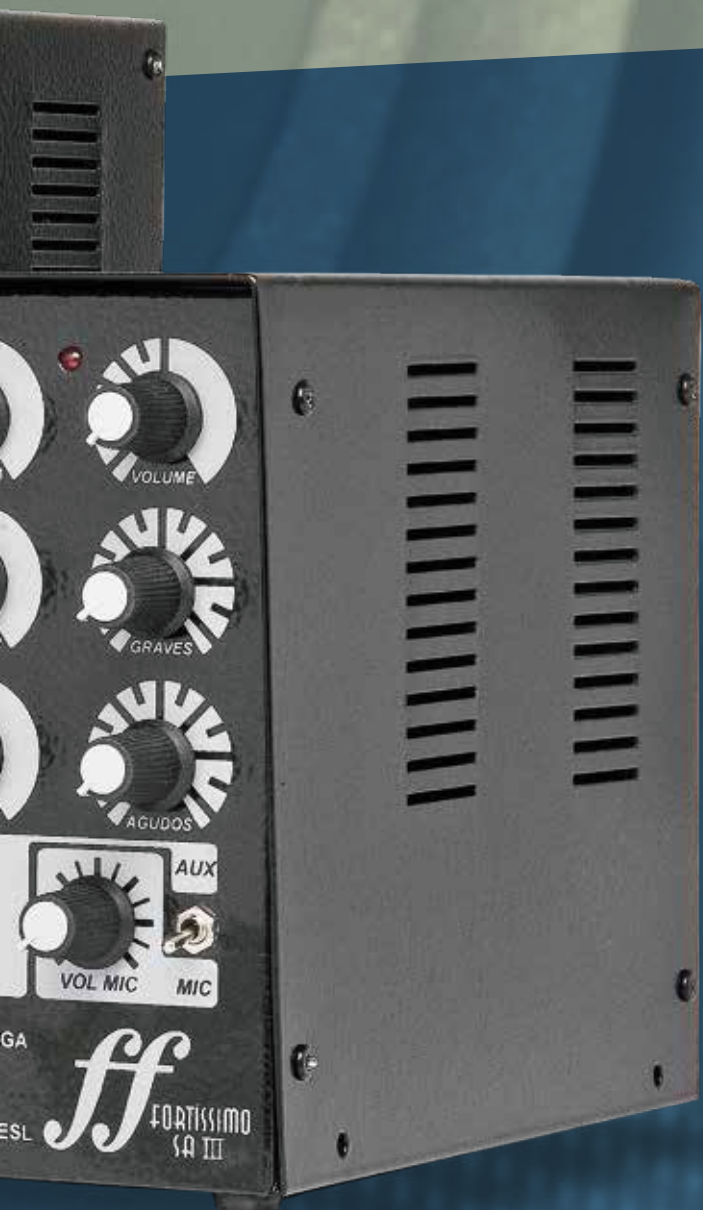

- ✓ Garantia de 6 meses
- ✓ Assistência Técnica Permanente
- ✓ Troca em 7 dias da venda do cliente ao cliente final.



AMPLIFICADOR PARA SOM AMBIENTE

- AMPLIFICADOR COM CONTROLE DE VOLUME INDEPENDENTE PARA 3 OU 5 AMBIENTES DIFERENTES.
- CONTROLE DE GRAVES E AGUDOS.
- ENTRADA PARA MICROFONE DE AVISOS.
- COMPATÍVEL COM SAÍDAS DE MP3, MP4, CD PLAYER, MICRO SYSTEM, TV, RÁDIO E COMPUTADORES.

24.00.001 - SA III
 PRETO POTÊNCIA: 36W RMS.
 DIMENSÕES: 8 X 16 X 22CM (L X A X P).

24.00.003 - SA V
 PRETO POTÊNCIA: 60W RMS.
 DIMENSÕES: 8 X 21 X 22CM (L X A X P).



24.08.017
REPETIDOR WIRELESS-N WIFI



24.08.018
TRANSMISSOR E RECEPTOR A/V WIRELESS



24.08.009
CHAVE SELETORA HDMI 3 X 1 PHEMON 1.4



24.08.011
CHAVEADOR SWITCH HDMI 2 PORTAS



24.08.012
CHAVEADOR SWITCH HDMI 4 PORTAS



24.08.023
DIVISOR SPLITER HDMI 1 X 4 SAÍDAS



SPLITER HDMI
24.08.007 - 1.4 1 X 2 C/ BLISTER PRETO

24.08.008 - 1.4 3D 1080P 1ENT X 4 SAÍDAS



24.08.025
CONVERSOR VGA+ HDMI COM RCA



24.08.027
CONVERSOR HDMI P/ AV UP SCALER 1080P



24.16.018
CONVERSOR HDMI P/ VGA COM ÁUDIO



24.16.013
CONVERSOR ÓPTICO PARA ANALÓGICO



24.01.034
CASE HDD 2.5



24.26.004
CONTROLE ROTATIVO P/ VENTILADOR DE TETO



24.26.006
DIMMER ROTATIVO



24.26.005
CONTROLE DESLIZANTE P/ VENTILADOR DE TETO



24.26.014
CHAVE ESP. ROTATIVA LD/RV SMART BIVOLT

Todos os nomes, logotipos de empresas e produtos citados neste catálogo são marcas registradas de suas respectivas corporações. A citação dos mesmos tem a única intenção de auxiliar nossos clientes na identificação de nossos produtos que são compatíveis com os originais.



24.26.015
CONTROLE REMOTO AT1



24.26.016
CONTROLE REMOTO AT2/W



24.08.003
DIVISOR DE IMAGEM 2 IN X 1 OUT



CHAVE VGA
24.16.020
1 X 2

24.16.021
1 X 4



24.16.005
MODULADOR DE RF MINI



24.10.041
FONTE DE 12V X 500MA



34.03.080
FONTE 12V X 1,5A P/ SKY HDTV



NOVO
05.01.132
CABO ACENDEDOR DE
CIGARRO + PLUG P-4



05.11.007
CARREGADOR VEICULAR PARA
CELULAR
V8/GALAXY



05.11.004
CABO CARREGADOR VEICULAR 6101



05.11.011
CARREGADOR VEICULAR ALUMÍNIO 2
PORTA USB



FONTE CARREGADOR USB P/ CELULARES IPHONE/IPAD
24.10.126 - 4 PORTAS



24.10.127 - 6 PORTAS



03.12.022
CARREGADOR BATERIA GO PRO HERO 3
BT301 CASA E VEICULAR



03.12.023
CARREGADOR BATERIA GO PRO HERO 1
HERO 2 CASA E VEICULAR



03.12.024
CARREGADOR
BATERIA CAMERA
SAMSUNG BP70A
CASA E VEICULAR



05.11.008
CARREGADOR
VEICULAR V8 CABO
ESPIRAL



05.11.012
CARREGADOR VEICULAR PARA CELULAR V8



24.26.012
CARREGADOR CASA USB 2 PORTAS



05.11.005
CARREGADOR USB VEICULAR 2000MA



05.11.006
CARREGADOR VEICULAR IPHONE4-4S/5

Cabo Para Fonte Fio Paralelo 2x24

**OFERTA PARA
ZERAR
ESTOQUE**

05.12.077
CABO FONTE P4
3,0 X 6,4 180° C FILTRO



05.12.078
CABO FONTE P4
1,35 X 3,5 180° C FILTRO



05.12.079
CABO FONTE P4
2,1 X 3,5 180° C FILTRO



05.12.080
CABO FONTE P4
1,7 X 4,8 180° C FILTRO



Fontes



FONTE CHAVEADA BLINDADA 110/220

- 24.10.014 - SAÍDA 12V / 50W - 4A.....
- 24.10.016 - SAÍDA 12V / 100W - 8A.....
- 24.10.017 - SAÍDA 12V / 145W - 12A.....
- 24.10.018 - SAÍDA 12V / 201W - 16A.....
- 24.10.019 - SAÍDA 12V / 350W - 30A.....
- 24.10.020 - SAÍDA 12V / 500W - 40A.....
- 24.10.021 - SAÍDA 24V / 25W - 1A.....
- 24.10.022 - SAÍDA 24V / 50W.....
- 24.10.023 - SAÍDA 24V / 75W - 3A.....

Todos os nomes, logotipos de empresas e produtos citados neste catálogo são marcas registradas de suas respectivas corporações. A citação dos mesmos tem a única intenção de auxiliar nossos clientes na identificação de nossos produtos que são compatíveis com os originais.



24.10.031
F CHAVEADA
FONTE CHAVEADA
110/220 - 12V10A - 120W



24.10.033
FONTE P4
FONTE CHAVEADA 110/220 -
5V 1A - P4 C + 2,1 X 5,5 MM



24.10.034
FONTE P4
FONTE CHAVEADA 110/220 -
5V 2A - P4 C + 2,1 X 5,5 MM



24.10.035
FONTE P4
FONTE CHAVEADA 110/220 - 9V 2A -
P4 C + 2,1 X 5,5 MM



24.10.036
FONTE P4
FONTE CHAVEADA 110/220 - 9V 500MA - P4 C +



24.10.037
FONTE P4
FONTE CHAVEADA 110/220 - 9V 1A - P4 C +



24.10.038
FONTE P4
FONTE CHAVEADA 110/220 - 12V 1A - P4 C +



24.10.039
FONTE P4
FONTE CHAVEADA 110/220 - 12V 2A - P4 C +



CÓDIGO	COMPATÍVEL COM MODELOS
34.03.028	ACER 19V X 2,15A DC. 5.5X2.5 90° ULTRABOOK
34.03.094	ACER 19V X 4,74A PLUG 5.5 X 1.7
34.03.033	ACER 19V X 3,42A PLUG 5.5 X 1.7
34.03.082	APPLE MAC BOOK 60W T
34.03.037	APPLE MAC BOOK 60W L
34.03.083	APPLE MAC BOOK 85W T
34.03.087	ASUS 19V X 1,75A PLUG 4.0X1,35
34.03.030	ASUS 19V X 2,1A PINO AGULHA
34.03.095	ASUS 19V X 2,37A PLUG 4.0X1,35
34.03.096	ASUS 19V X 2,37A PLUG 3.0X1.1
34.03.041	ASUS 19V X 3,42A PLUG 5.5 X 2.5
34.03.060	CCE 20V X 3,25A PLUG 5.5 X 2.5
34.03.064	DELL ULTRA 19.5V X 3.34A PLUG 4.0X1.7
34.03.025	DELL 19,5V X 3,34A PLUG 7.4 X 5.0
34.03.020	DELL 19,5V X 4,62A PLUG 7,4 X 5.0
34.03.063	DELL-ULTRA 19.5V X 231A PLUG 4.5X3.0
34.03.024	HP 18,5V X 3,5A PLUG 4,8 X 1,7 AM
34.03.019	HP 18,5V X 3,5A PLUG 7,4 X 5
34.03.069	HP 19,5V X 2,05V PLUG 4.0 X 1.7
34.03.023	HP 19V X 4,74A PLUG 7.4 X 5
34.03.034	HP NET 19V X 2,05A
34.03.071	HP PLUG AZUL 90°
34.03.047	HP ULTRABOOK 19,5V X 3,33A DC. 4.8X1.7

CÓDIGO	COMPATÍVEL COM MODELOS
34.03.061	ITAUTEC 20V X 3,25A PLUG 5.5 X 2.5
34.03.086	LENOVO 20V X 3,25A PLUG RET. C/AGULA
34.03.093	LENOVO 20V X 2.25A PLUG 4.0 X 1.7
34.03.029	LENOVO 20V X 3,25A 65W PLUG 7.9 X 5.0
34.03.070	LENOVO 20V X 4.5 90W PLUG 7.9 X 5.0
34.03.067	LENOVO PLUG 20V X 4,5 RETANGULAR C/AGULA
34.03.038	LG PLUG 18,5V X 3,5A 6.4 X 44 C/AGULHA
34.03.090	LG/LITEON 19V X 3,42A 6.4 X 44 C/AGULHA
34.03.072	LG/LITEON 19V X 3,42A DC 5.5 X 2.5
34.03.021	LITEON 19V 3,42A DC.5.5X2,5
34.03.022	LITEON 20V 3,25A DC.5.5X2.5
34.03.073	PHILCO 19V X 3,42A PLUG 5.5 X 2.5
34.03.045	PHILCO/NET 19V X 2.1A DC.3.5 X 1.35
34.03.057	POSITIVO 19VX3,42 PLUG 5.5X2.5
34.03.035	SAMSUNG 19V 3,16A DC.5.0 X 3.0
34.03.031	SAMSUNG 19V 3,16A DC.5.0X3,2X11,5
34.03.032	SAMSUNG 19V 4,74A DC 5.5 X 3.2 X 1.0
34.03.051	SAMSUNG 19V X 2.1A
34.03.026	SONY 19.5V 4,7A DC: 6.5 X 4.4
34.03.066	SONY 19.5V X 3,9 PLUG DC 6.5X4.4
34.03.039	TOSHIBA 19V 4.7A DC.5.5X2.5
34.03.044	TOSHIBA 19V X 3,42A
24.10.132	12V X 2A 100/240V 600MA SEM CABO AC



Fonte Para Monitor

CÓDIGO	COMPATÍVEL COM MODELOS
34.03.076	LG 12V X 2,5A

CÓDIGO	COMPATÍVEL COM MODELOS
34.03.085	SAMSUNG 14V X 2,5A DC 6.0MM



CÓDIGO	COMPATÍVEL COM MODELOS
34.03.055	HP 32V X 940MA E 16V X625MA
34.03.056	HP 32V X 625MA PLUG ROXO
34.03.057	HP 32V X 375MA E 16V X500MA
34.03.077	HP 22V PINO ROXO

CÓDIGO	COMPATÍVEL COM MODELOS
34.03.089	HP 30VX333MA ROXO
34.03.091	EPSON AP024-20XL 24V - 2A 3 PINOS
34.03.088	24V X 3A 4 PINOS LZ2430

Fontes para Xbox



34.03.074
FONTE XBOX 360 SLIM

34.03.075
FONTE XBOX 360E SUPER SLIM

34.03.079
FONTE XBOX360 ONE

Nossos Contatos:



www.facebook.com/tndeletro



www.tndeletro.com.br



11 99408-1811



LEIA NA PÁGINA 1 DO CATÁLOGO SOBRE NOSSA POLÍTICA DE VENDA, TROCA E GARANTIA



Todos os nomes, logotipos de empresas e produtos citados neste catálogo são marcas registradas de suas respectivas corporações. A citação dos mesmos tem a única intenção de auxiliar nossos clientes na identificação de nossos produtos que são compatíveis com os originais.



05.12.166
CABO USB CARREGADOR
MAGNETICO SONY XPERIA

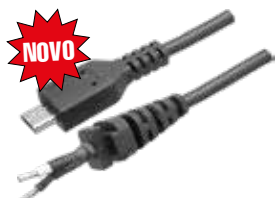

NOVO
05.12.201
CABO COM FILTRO CONECTOR
V8



NOVO
05.12.200
CABO PARA FONTE DE
NOTEBOOK 4,8 X 1,7MM 90°

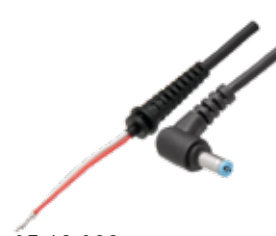

05.12.082
ACER P4 1,7 X 5,5 MM AM.



05.12.177
5,5 X 1,7 FIO PARALELO
1,10MT BUCHA REDONDA
ORIGINAL



05.12.025
HP P4 1,7 X 4,8MM



05.12.072
IBM/LENOVO



05.12.141
LENOVO USB RETANGULAR C/
AGULHA



05.12.056
P4 2,5 X 5,5 90° DIVERSOS



05.12.179
5,5 X 2,5 90° 3,50MT
BUCHA QUADRADA **ORIGINAL**



05.12.027
DEL/HP P4 7,4 X 5,0 C/ PINO
CENTRAL



05.12.071
HP PLUG BALA



05.12.062
P4 1,7 X 4,0 MM AMARELO



05.12.162
HP ULTRA BOOK PRETO



05.12.043
P4 2,5 X 5,5 MM BUCHA
QUADRADA



05.12.185
5,5 X 2,5 90° 2,20MT BUCHA
QUADRADA **ORIGINAL**



05.12.061
P4 3,0 X 6,4 MM



05.12.044
P4 3,5 X 4,0 MM BUCHA QUAD
C AGUL



05.12.186
6,4 X 4,30 1,80MT C/PINO
CENTRAL 90° BUCHA REDONDA
ORIGINAL



05.12.064
P4 6,4 C/ PINO CENTRAL
AMARELO



05.12.183
6,4 X 4,0 180° C/PINO
CENTRAL BUCHA
REDONDA 1,40 MT
ORIGINAL



05.12.085
PLUG 2,5 X 0,7MM



05.12.084
PLUG 3,5 X 1,1MM



05.12.083
PUG 3,5 X 1,35MM



05.12.178
5,9 X 4,3 90° PINO
CENTRAL 1,40M BUCHA
REDONDA **ORIGINAL**



05.12.042
CABO P/ FONTE NOTEBOOK
SONY P4 4,3 X 5,9 C/ PINO
CENTRAL



05.12.202
CABO P/ FONTE NOTEBOOK
SONY P4 4,3 X 5,9MM PINO
CENTRAL SEM FILTRO 1,80 MT



05.12.182
4,3 X 5,9 C/FILTRO PINO
CENTRAL 1,45MT BUCHA
QUADRADA **ORIGINAL**



05.12.148
CABO FONTE ULTRA BOOK
HP AZUL



05.12.149
CABO FONTE ULTRA BOOK
SAMSUNG

Todos os nomes, logotipos de empresas e produtos citados neste catálogo são marcas registradas de suas respectivas corporações. A citação dos mesmos tem a única intenção de auxiliar nossos clientes na identificação de nossos produtos que são compatíveis com os originais.



12.08.035
JACK P/ NOTEBOOK POSITIVO
5.5X2.5



12.08.076
JACK P/ MONITOR SONY/
SAMSUNG



12.08.036
JACK P/ NOTEBOOK SAMSUNG
SÉRIE NP300



12.08.037
JACK P/ NOTEBOOK SAMSUNG
SÉRIE RV111



12.08.038
FONTE P/ NOTEBOOK 4.8X1.7
TODOS



12.08.078
JACK PARA FONTE DE
NOTEBOOK 4,8 X 1,7 MM



12.08.039
FONTE P/NOTEBOOK
CCE - NET - PHILCO - WIN



12.08.040
FONTE P/ NOTEBOOK DELL -
VOSTRO



12.08.066
JACK P/ NOTE DELL



12.08.041
FONTE P/ NOTEBOOK PHILCO -
CCE 5.5XC2.5MM



12.08.042
FONTE P/ NOTEBOOK LG



12.08.071
JACK P/ NOTEBOOK
HP PV5000 DC



12.08.065
JACK P/ NOTEBOOK DELL HP



12.08.046
JACK P/NOTE DELL/HP



12.08.079
JACK PARA FONTE DE NOTEBOOK DELL
/ HP CINZA



12.08.070
JACK P/ NOTEBOOK ACER AMARELO
DC 65W



12.08.060
JACK P/ NOTEBOOK ACER



12.08.062
JACK P/ NOTEBOOK SAMSUNG DC540



12.08.063
JACK P/ NOTE BOOK ACER LARANJA



12.08.064
JACK P/ NOTE BOOK PHILCO DC045



12.08.067
JACK P/ NOTE SAMSUNG S/ CAPA



12.08.051
JACK P/ NOTE POSITIVO



12.08.052
JACK P/ NOTE ACER



12.08.054
JACK J4 3.5 X 1.35 DIV.
APAR. IMPORTADO



12.08.055
JACK DC P/ TABLET 2.5 X 0.7



12.08.074
JACK DC MP DV 5000 4.8 X 1.7

Nossos Contatos:



www.facebook.com/tndeletro



www.tndelettronica.com.br



11 99408 1811



12.12.094
PLUG ADAPTADOR 7.4X5.0MM
LAPTOP DELL/HP PINO
CENTRAL



12.12.095
PLUG ADAPTADOR 7.9X5.5MM
LAPTOP IBM/LENOVO PINO
CENTRAL



12.12.184
PLUG ADAPTADOR P4 FÊMEA
5.5MM C 2.5MM P/ LENOVO
RETANGULAR



12.12.096
PLUG ADAPTADOR
6.0X4.4MM - LAPTOP LG E
SONY PINO CENTRAL



12.12.097
PLUG ADAPTADOR 6.3X3.0MM
LAPTOP TOSHIBA



12.12.098
PLUG ADAPTADOR 5.5X2.5MM
LAPTOP DIVERSOS



12.12.099
PLUG ADAPTADOR 5.5X1.7MM
LAPTOP ACER



12.12.100
PLUG ADAPTADOR 4.0X1.7
LAPTOP AMARELO



12.12.101
PLUG ADAPTADOR 3.5X1.35
LAPTOP VERMELHO



12.12.102
PLUG ADAPTADOR 0,7MM
AMARELO



12.12.119
PLUG ADAPTADOR 5.0X3.0
LAPTOP SAMSUNG PINO
CENTRAL



12.12.123
PLUG ADAPTADOR 6.3 LAPTOP
TOSHIBA



12.12.161
PLUG ADAPTADOR 6.0 C/ PINO
CENTRAL 90 GRAU



12.12.139
PLUG ADAPTADOR 3.5 X 1.35
90 GRAUS



12.12.140
PLUG ADAPTADOR 4.0 X 1.7 90
GRAU



12.12.141
PLUG ADAPTADOR 4.8 X 1.7 90 GRAU



12.12.142
PLUG ADAPTADOR 5.5 X 1.7 90 GRAU



12.12.143
PLUG ADAPTADOR 5.5 X 2.1 90 GRAU



12.12.144
PLUG ADAPTADOR 5.0 SAMSUNG 90
GRAU



24.01.020
SUPORTE UNIVERSAL
TV FIXO P TV ATÉ 10" - 70"



24.01.075
SUPORTE FIXO UNIVERSAL 14-105" AL



24.01.076
SUPORTE FIXO LINHA PRÁTICA UN
ALUMÍNIO



24.01.071
SUPORTE UNIVERSAL TV FIXO P TV
10" A 71" CAIXA MARINI



24.01.072
SUPORTE UNIVERSAL TV FIXO P TV
10" A 43" BLISTER MARINI



24.01.021
SUPORTE TV FIXO P TV ATE 26" QS10



24.01.025
SUPORTE TV ARTICULADO ATE 32"
QS40



24.01.073
SUPORTE UNIVERSAL TV FIXO P TV 10"
A 43" ARTICULAD MARINI

Microventilador



- | | |
|---|--|
| 24.14.019 40 X 40 X 10MM 12VDC GC..... | 24.14.023 80 X 80 X 25MM 12VDC GC..... |
| 24.14.002 40 X 40 X 10MM 12VDC ALL..... | 24.14.006 80 X 80 X 25MM 12VDC ZX..... |
| 24.14.000 40 X 40 X 10MM 12VDC ZX..... | 24.14.015 80 X 80 X 25MM 12VDC ALL..... |
| 24.14.020 40 X 40 X 20MM 12VDC ZX..... | 24.14.036 90 X 90 X 25MM 12VDC ALL..... |
| 24.14.003 40 X 40 X 20MM 12VDC GC..... | 24.14.026 120 X 120 X 25MM 110/220V C/ROLAMENTO ZX..... |
| 24.14.022 60 X 60 X 20MM 12VDC GC..... | 24.14.028 120 X 120 X 25MM 110/220V S/ROLAMENTO ZX..... |
| 24.14.004 60 X 60 X 20MM 12VDC ZX..... | 24.14.017 120 X 120 X 38MM 110/220V BUCHA METÁLICA..... |
| 24.14.005 60 X 60 X 20MM 12VDC ALL..... | 24.14.030 120 X 120 X 38MM 110/220V C /ROLAMENTO ZX..... |
| | 24.14.018 120 X 120 X 38MM 110/220V BUCHA METÁLICA..... |

Relês

12VDC 10A 5T
125V DC T73 JQC 3F AZ
25.01.007 - AZ
25.01.008 - PT

25.01.016
RELE 12V 5A 120VAC
MIT-SH-112LM AZUL

25.01.017
RELE 12V 10A - 30VDC
120VAC GJ-SH-112LM AZUL

25.01.014
RELE 12V HJR1-2C
L-12V 1A 12V / 2A 24V

20A 5T 125V DC T74
25.01.009 - 12VDC
25.01.011 - 24 VDC

20A 6T 125V DC T90 JQX 15F
25.01.013 - 12VDC
25.01.012 - 24 VDC

25.01.005
5VDC 10A 5T 125V JQC 3F

25.01.010
24VDC 10A 5T 125V DC T73 JQC 3F

Ressonador / Sensor LDR

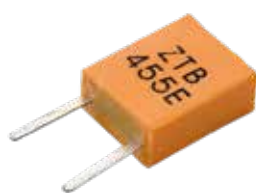

- 14.01.002 CSB 393 2P.....
- 14.01.005 ZTB 429 2P.....
- 14.01.012 CRB 455E 2P...
- 14.01.014 LPU 465B 3P...
- 14.01.015 ZTB 500K 2P...
- 14.01.016 ZTB 503F 2P...
- 14.01.018 5.85MHZ.....



- 14.01.020 27MHZ....
- 14.01.021 14,3MHZ.



- 14.01.017 4.5MHZ...



- 15.09.003
SENSOR DE LUZ 7MM

Soquetes

31.00.013
SOQUETE P/ TUBO DIVERSOS MODELOS

31.00.014
SOQUETE P/ TUBO DIVERSOS

31.00.015
SOQUETE P/ TUBO
MINI7 PINOS + 1 SHARP 14" ANTIGA

31.00.016
SOQUETE TUBO 9 PINOS TV LG

31.00.017
SOQUETE DE TUBO 9 PINOS
MONITOR DIVERSOS

31.00.018
SOQUETE P/ TUBO 8 PINOS

31.00.021
SOQUETE P/TUBO FOCO ALTO
LG 073612 GZS 10-2-5

31.00.023
SOQUETE P/TUBO MINI NECK

Todos os nomes, logotipos de empresas e produtos citados neste catálogo são marcas registradas de suas respectivas corporações. A citação dos mesmos tem a única intenção de auxiliar nossos clientes na identificação de nossos produtos que são compatíveis com os originais.

**OFERTA PARA
ZERAR
ESTOQUE**



19MM RECARILHADO KA 481
 32.17.009 - AM 32.17.012 - VD
 32.17.010 - AZ 32.17.013 - VM
 32.17.011 - BC



32.17.015
 KNOB DESLIZANTE SL-10 CINZA



32.17.016
 KNOB DESLIZANTE SL-11 CINZA



32.17.017
 KNOB DESLIZANTE SL-12



32.17.018
 KNOB DESLIZANTE SL-09



32.17.019
 KNOB DESLIZANTE SL-08
 PRETO



32.17.021
 KNOB ROTATIVO ESTRIADO
 KP200-E VERMELHO



32.17.022
 KNOB ROTATIVO ESTRIADO
 KP200-E AZUL



32.17.023
 KNOB ROTATIVO ESTRIADO
 KP200-E AMARELO



32.17.024
 KNOB ROTATIVO ESTRIADO
 KP200-E LARANJA



32.17.025
 KNOB ROTATIVO ESTRIADO
 KP200-E VERDE



32.17.026
 KNOB KP301S ESTRIADO MESA
 DE SOM PRETO + AMARELO



32.17.027
 KNOB KP301S ESTRIADO MESA
 DE SOM PRETO + BCO.



32.17.028
 KNOB KP301S ESTRIADO MESA
 DE SOM PRETO + AZUL



32.17.029
 KNOB KP301S ESTRIADO MESA
 DE SOM PRETO + VERDE



32.17.030
 KNOB KP301S ESTRIADO MESA
 DE SOM PRETO + VERMELHO



32.17.031
 KNOB KP301S ESTRIADO MESA
 DE SOM CINZA + AMARELO



32.17.032
 KNOB KP301S ESTRIADO MESA
 DE SOM CINZA + AZUL



32.17.033
 KNOB KP301S ESTRIADO MESA
 DE SOM CINZA + CINZA



32.17.034
 KNOB KP301S ESTRIADO MESA
 DE SOM CINZA + PRETO



32.17.035
 KNOB KP301S ESTRIADO MESA
 DE SOM CINZA + VERMELHO



32.17.041
 KNOB ROTATIVO KB3015 -
 CINZA + BRANCO



32.17.036
 KNOB 303S ESTRIADO CINZA +
 BRANCO



32.17.037
 KNOB 303S ESTRIADO CINZA
 + PRETO

Buchas Teflon / Trava de Porta



35.00.001
BUCHA TEFLON TO 3 (PREÇO CENTO)



BUCHA TEFLON TO 220 (PREÇO CENTO)
35.00.000 - ALTA
35.00.002 - BAIXA



32.17.006
TRAVA DA PORTA CD ENCAIXE UNIVERSAL



32.17.007
TRAVA DA PORTA CD ENCAIXE UNIVERSAL C/ CHAVE

Todos os nomes, logotipos de empresas e produtos citados neste catálogo são marcas registradas de suas respectivas corporações. A citação dos mesmos tem a única intenção de auxiliar nossos clientes na identificação de nossos produtos que são compatíveis com os originais.

Mica Isolante / Parafuso



35.00.003
3 OVAL



35.00.004
T092 28X22 C/ FURO



35.00.006
T0218/247 22X16,5 C/ FURO



35.00.008
T0220 19,3X4 C/ FURO



PARAFUSO KIT
35.00.012 - TO 3
35.00.013 - TO 220

Trimmer



36.04.001 2 A 7 PF AZUL (NPO ± 200PPM /°C)
36.04.002 4 A 20 PF ROSA (N450 ± 300PPM /°C).....
36.04.003 5,2 A 30 PF VERDE (N750 ± 300PPM /°C).....

36.04.004 6,8 A 45 PF AMARELO (N1200 ± 500PPM /°C)
36.04.005 9,8 A 60 PF MARRON (NPO ± 500PPM /°C)

Trimpot

VERTICAL MINI 8 MM



23.26.010 1 K.....
23.26.012 3,3 K.....
23.26.014 6,8 K.....
23.26.015 10 K.....
23.26.041 50 K.....
23.26.019 220 K.....
23.26.021 470 K.....
23.26.022 680 K.....
23.26.023 1 M.....

HORIZONTAL 8 MM



23.26.027 3,3 K.....
23.26.030 10 K.....
23.26.033 100 K.....
23.26.037 500 K.....

10 MM HORIZONTAL MINI C/ BOTÃO



23.39.037 470K.....
23.39.038 10K.....

10 MM VERTICAL MINI C/ BOTÃO



23.39.028 47K.....

14 MM VERTICAL MINI C/ BOTÃO



23.40.022 2K2.....
23.40.030 220K.....

Trimpot Precisão

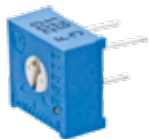

1 VOLTA - RE F. 3386F
23.36.003 100R.....
23.36.004 200R.....
23.36.006 1 K.....
23.36.007 2 K.....
23.36.008 5 K.....
23.36.009 10 K.....
23.36.010 20 K.....
23.36.011 50 K.....
23.36.012 100 K.....
23.36.013 200 K.....
23.36.014 500 K.....
23.36.015 1 M.....

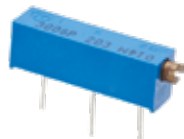

15 VOLTAS - RE F 3006P
23.37.003 100R.....
23.37.006 1 K.....
23.37.008 5 K.....
23.37.010 20 K.....
23.37.013 200 K.....
23.37.015 1 M.....

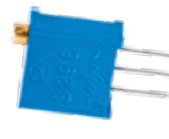

25 VOLTAS - 3296W
23.38.003 100R.....
23.38.005 500R.....
23.38.006 1 K.....
23.38.007 2 K.....
23.38.008 5 K.....
23.38.009 10 K.....
23.38.010 20 K.....
23.38.011 50 K.....
23.38.012 100 K.....
23.38.013 200 K.....

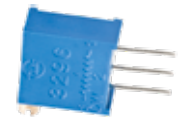

25 VOLTAS - RE F 3296X
23.38.015 50R.....
23.38.016 100R.....
23.38.017 200R.....
23.38.019 1 K.....
23.38.021 5 K.....
23.38.022 10 K.....
23.38.026 200 K.....
23.38.027 500 K.....



18.01.048
ALICATE CORTADOR E DECAPADOR DE CABO COAXIAL RG 59 / RG 6 / 11/ 7



18.01.013
ALICATE DECAPAR HY-332



18.01.045
ALICATE DECAPADOR DE CABO COAXIAL HY-323



18.01.049
ESTILETE LARGO PROFISSIONAL



18.01.050
ESTILETE LARGO EXCELLENT



18.01.051
LÂMINA P/ ESTILETE 18MM CAIXA C/ 10 PEÇAS



18.06.008
TESTADOR CABO DE REDE ALL-468 RJ11+RJ45



18.06.009
TESTE DE CABO REDE UTP/CATV/CABLE MODEM/USB



24.08.010
TESTADOR DE CABO HDMI



18.01.021
PULSEIRA ANTI-ESTATICA



18.01.019
TESTE DE VOLTAGEM 90V - 1000 VAC



18.02.000
MINI FURADEIRA TZF44 12VDC



18.01.044
ALICATE PUNCH DOWN HY-314B LARANJA



18.01.052
REBITADOR BAR-5869-1



18.01.015
DECAPADOR DE FIO C/ REGULAGEM HY-150B



18.01.010
ALICATE CRIMPAR HY-568R CRIMPAR 8X8 E 6X6 C/ CATRACA



18.01.009
ALICATE CRIMPAR HY-210C CRIMPAR 8X8 RJ 45



18.01.011
ALICATE H 518A CRIMPAR CONECTOR DE COMPRESSÃO



18.01.026
ALICATE GC-5089 CRIMPAR CONECTOR RG59/RG6 HY-5089



18.01.034
ALICATE CONECTOR F COMPRESSÃO HY-H548A1

Todos os nomes, logotipos de empresas e produtos citados neste catálogo são marcas registradas de suas respectivas corporações. A citação dos mesmos tem a única intenção de auxiliar nossos clientes na identificação de nossos produtos que são compatíveis com os originais.



18.01.018
ALICATE DE CORTE HY.5023
AWG30/28/26/24/22/20



18.01.020
ALICATE DE CORTE



18.01.047
ALICATE CORTE DIAGONAL 6" EDA



18.01.028
KIT DE ALICATE BICO/CORTE/
UNIVERSAL
4.5" VERMELHO



18.01.029
KIT DE ALICATE BICO/CORTE/
UNIVERSAL 4.5" AMARELO



18.01.035
ALICATE MEIA
CANA BICO LONGO 6"

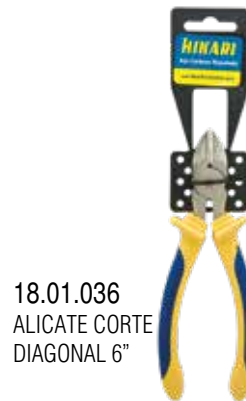

18.01.036
ALICATE CORTE
DIAGONAL 6"



18.01.037
ALICATE DE BICO
LONGO CURVO
HK-500



18.01.038
ALICATE DE BICO
RETO HK-501



18.01.039
ALICATE BICO
PRETO LISO
HK-503



18.01.041
ALICATE CORTE
FRONTAL HK-505



18.01.042
ALICATE BICO
REDONDO CURTO
HK-506



18.16.043
JOGO DE
FERRAMENTAS
COM 7 PEÇAS

18.01.022
ASSISTENTE
PARA SOLDAGEM
6 PEÇAS

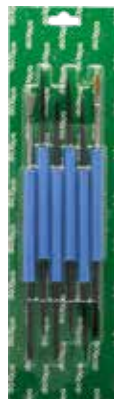

18.16.031
KIT FERRAMENTAS
PARA IPHONE

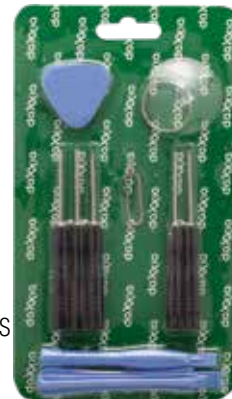

18.16.032
KIT FERRAMENTAS
IPHONE 4
C/ 7 PEÇAS



18.16.033
KIT FERRAMENTAS
P/ IPHONE
C/ 10 PEÇAS



18.16.034
KIT FERRAMENTAS
P/ IPHONE
C/ 12 PEÇAS



18.16.029
KIT FERRAMENTAS
P/ IPHONE
C/ 25 PEÇAS

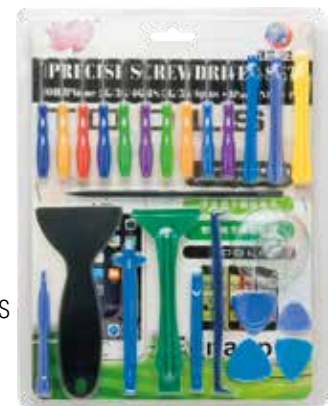



18.16.049
KIT FERRAMENTAS P/ CELULAR 16 EM 1



18.16.042
CHAVE TESTE
VOLTAGEM AC/DC
12A 220V - EDA



18.16.041
CHAVE DE FENDA TESTE 5 1/2"



18.16.036
KIT TESTE ELÉTRICO
DE 6-24 VOLTS C/ 12 PEÇAS



18.16.005
KIT CHAVES DE PRECISÃO C/ 06 - EDA



18.16.006
KIT CHAVES DE PRECISÃO C/ 11 - EDA



18.16.026
KIT CHAVES TORX C/ 06



18.16.012
KIT CHAVES TORX C/ 07 - EDA



18.16.039
KIT CHAVE TORK 6 PEÇAS - EDA



18.16.017
KIT DE CHAVE 6 CHAVES PONTA DUPLA
AZUL



18.16.018
KIT DE CHAVES LARANJA



18.16.014
KIT FERRAMENTAS JK6066-B



18.16.030
KIT FERRAMENTA PARA CELULAR
33 IN 1



18.16.037
ESTOJINHO DE FERRAMENTAS C/ 9 PÇS
PRECISÃO P/ CONSERTOS TVS - EDA



18.16.010
KIT CHAVES DE PRECISÃO RELOJEIRO
C/ 06 - EDA



18.16.024
KIT C/ 31 CHAVES

Todos os nomes, logotipos de empresas e produtos citados neste catálogo são marcas registradas de suas respectivas corporações. A citação dos mesmos tem a única intenção de auxiliar nossos clientes na identificação de nossos produtos que são compatíveis com os originais.



18.16.021
KIT C/ 10 CHAVES ALLEN CROMADA

18.16.038
CORTADOR DE PLACA DE CIRCUITO IMPRESSO



18.04.011
LUPA COM SUPORTE E PINÇAS



NOVO



18.04.003
SUPORTE PARA PLACA COM LUPA



18.04.010
À RECEBER

LUPA (EMB. CAIXA)
18.04.009 - 40MM
18.04.010 - 50MM
18.04.005 - 80MM
18.04.006 - 90MM



18.04.007
LUPA DE CABEÇA CT7103

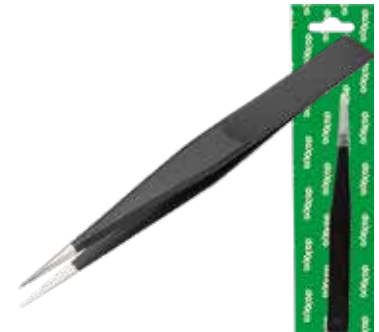

18.07.019
PINÇA ANTI-ESTÁTICA 125MM X 11MM A

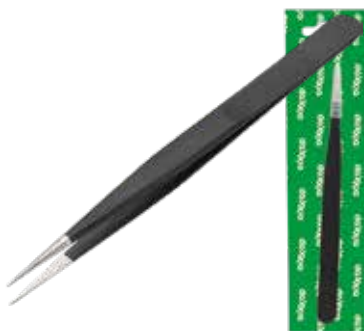

18.07.020
PINÇA ANTI-ESTÁTICA 135MM X 9MM C

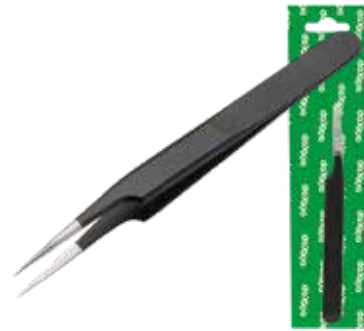

18.07.021
PINÇA ANTI-ESTÁTICA 115MM X 9MM

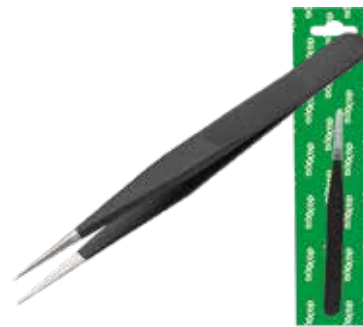

18.07.022
PINÇA ANTI-ESTÁTICA 110MM X 9MM B

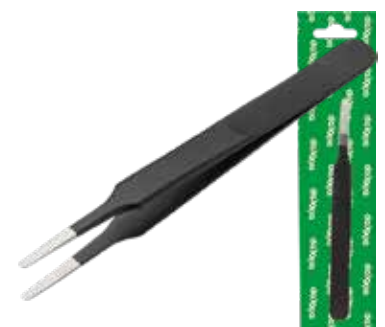

18.07.023
PINÇA ANTI-ESTÁTICA 120MM X 9MM D

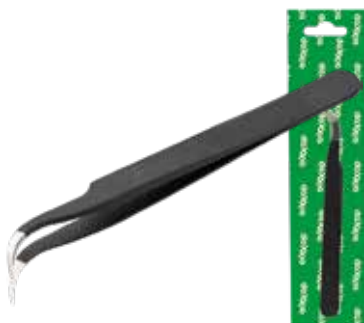

18.07.024
PINÇA ANTI-ESTÁTICA 120MM X 9MM F



18.07.014
PINÇA METÁLICA DS-14



18.07.015
PINÇA METÁLICA DS-15



18.07.017 RETA TS10
18.07.018 RETA TS11

MICRO PINÇA ISOLADA PI 0810
C/ PINO BANANA
18.07.003 - COR PRETA
18.07.004 - COR VERMELHA



PINÇA FLEXÍVEL PI 800
18.07.001 COR PRT
18.07.002 COR VRM



PINÇA JACARÉ ISOLADA PJ 830
18.07.005 - COR PRETA
18.07.006 - COR VERMELHA



18.19.006
ESCOVA 3 PEÇAS
AÇO E NYLON



18.19.001
ESCOVA ESD



18.19.002
PINCEL ESD DS-1858



18.19.003
PINCEL ESD DS-217



18.08.004
PISTOLA DE COLA
11MM BIVOLT



18.12.022
TRENA LASER
CP-3007



Fones de Ouvido / Espuma Protetora

24.09.042
FONE DE OUVIDO BRANCO CAIXA ACRILICA IPHONE



24.09.020
FONE DE OUVIDO
MP3/MP4 DIVERSOS



16.32.001
ESPUMA PROTETORA P/ FONE HEADSETS 5.5CM



16.32.000
ESPUMA PROTETORA P/ FONE HEADSETS 5CM



24.01.046
SUPORTE (BASE)
P/ NOTEBOOK



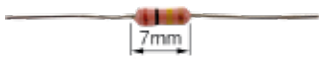

RESISTOR CARVÃO
1/4W 7MM
VALORES DE 1R A 10M



RESISTOR 1W



RESISTOR 2W

RESISTOR CARBONO
3W 7MM

Todos os nomes, logotipos de empresas e produtos citados neste catálogo são marcas registradas de suas respectivas corporações. A citação dos mesmos tem a única intenção de auxiliar nossos clientes na identificação de nossos produtos que são compatíveis com os originais.

26.01.008 1R	26.01.051 1K8
26.01.009 1R2	26.01.052 2K2
26.01.010 1R5	26.01.053 2K7
26.01.011 1R8	26.01.054 3K3
26.01.012 2R2	26.01.055 3K9
26.01.013 2R7	26.01.056 4K7
26.01.014 3R3	26.01.057 5K6
26.01.015 3R9	26.01.058 6K8
26.01.016 4R7	26.01.059 8K2
26.01.017 5R6	26.01.060 10K
26.01.018 6R8	26.01.061 12K
26.01.019 8R2	26.01.062 15K
26.01.020 10R	26.01.063 18K
26.01.021 12R	26.01.064 22K
26.01.022 15R	26.01.065 27K
26.01.023 18R	26.01.066 33K
26.01.024 22R	26.01.067 39K
26.01.025 27R	26.01.068 47K
26.01.026 33R	26.01.069 56K
26.01.027 39R	26.01.070 68K
26.01.028 47R	26.01.071 82K
26.01.029 56R	26.01.072 100K
26.01.030 62R	26.01.073 120K
26.01.031 68R	26.01.074 150K
26.01.032 82R	26.01.075 180K
26.01.033 100R	26.01.076 220K
26.01.034 120R	26.01.077 270K
26.01.035 150R	26.01.078 330K
26.01.036 180R	26.01.079 390K
26.01.037 200R	26.01.080 470K
26.01.038 220R	26.01.081 560K
26.01.039 270R	26.01.082 680K
26.01.040 330R	26.01.083 820K
26.01.041 390R	26.01.092 10M
26.01.042 470R	26.01.084 1M
26.01.043 560R	26.01.085 1M2
26.01.044 620R	26.01.086 1M5
26.01.045 680R	26.01.087 1M8
26.01.046 820R	26.01.088 2M2
26.01.047 910R	26.01.089 4M7
26.01.048 1K	26.01.090 5M6
26.01.049 1K2	26.01.091 6M8
26.01.050 1K5	

R\$ 5,06 (PREÇO DO CENTO)

26.01.000 0,10R	26.01.005 0,56R
26.01.001 0,22R	26.01.006 0,68R
26.01.003 0,33R	26.01.007 0,82R
26.01.004 0,47R	

26.04.014 1R	26.04.056 1K5
26.04.015 1R2	26.04.057 1K8
26.04.016 1R5	26.04.058 2K2
26.04.017 1R8	26.04.059 2K7
26.04.018 2R2	26.04.060 3K3
26.04.019 2R7	26.04.061 3K9
26.04.020 3R3	26.04.062 4K7
26.04.021 3R9	26.04.063 5K6
26.04.022 4R7	26.04.064 6K8
26.04.023 5R6	26.04.065 8K2
26.04.024 6R8	26.04.066 10K
26.04.025 8R2	26.04.067 12K
26.04.026 10R	26.04.068 15K
26.04.027 12R	26.04.069 18K
26.04.028 15R	26.04.070 22K
26.04.029 18R	26.04.071 27K
26.04.030 22R	26.04.072 33K
26.04.031 27R	26.04.073 39K
26.04.032 33R	26.04.074 47K
26.04.033 39R	26.04.075 56K
26.04.034 47R	26.04.076 68K
26.04.035 56R	26.04.077 82K
26.04.036 62R	26.04.078 100K
26.04.037 68R	26.04.079 120K
26.04.038 82R	26.04.090 150K
26.04.039 100R	26.04.091 180K
26.04.040 120R	26.04.092 220K
26.04.041 150R	26.04.093 270K
26.04.042 180R	26.04.094 330K
26.04.043 200R	26.04.095 390K
26.04.044 220R	26.04.096 470K
26.04.045 270R	26.04.097 560K
26.04.046 330R	26.04.098 680K
26.04.047 390R	26.04.099 820K
26.04.048 470R	26.04.100 1M
26.04.049 560R	26.04.101 1M2
26.04.051 680R	26.04.102 1M5
26.04.052 820R	26.04.103 1M8
26.04.054 1K	26.04.104 2M2
26.04.055 1K2	26.04.105 4M7

R\$ 19,80 (PREÇO DO CENTO)

26.04.000 0,10R	26.04.008 0,47R
26.04.001 0,15R	26.04.009 0R56
26.04.002 0R22	26.04.010 0R68
26.04.004 0R27	26.04.011 0,75R
26.04.005 0,33R	26.04.012 0,82R
26.04.006 0,36R	
26.04.007 0,39R	

26.05.014 1R	26.05.056 1K5
26.05.015 1R2	26.05.057 1K8
26.05.016 1R5	26.05.058 2K2
26.05.017 1R8	26.05.059 2K7
26.05.018 2R2	26.05.060 3K3
26.05.019 2R7	26.05.061 3K9
26.05.020 3R3	26.05.062 4K7
26.05.021 3R9	26.05.063 5K6
26.05.022 4R7	26.05.064 6K8
26.05.023 5R6	26.05.065 8K2
26.05.024 6R8	26.05.066 10K
26.05.025 8R2	26.05.067 12K
26.05.026 10R	26.05.068 15K
26.05.027 12R	26.05.069 18K
26.05.028 15R	26.05.070 22K
26.05.029 18R	26.05.071 27K
26.05.030 22R	26.05.072 33K
26.05.031 27R	26.05.073 39K
26.05.032 33R	26.05.074 47K
26.05.033 39R	26.05.075 56K
26.05.034 47R	26.05.076 68K
26.05.035 56R	26.05.077 82K
26.05.036 62R	26.05.078 100K
26.05.037 68R	26.05.079 120K
26.05.038 82R	26.05.080 150K
26.05.039 100R	26.05.081 180K
26.05.040 120R	26.05.082 220K
26.05.041 150R	26.05.083 270K
26.05.042 180R	26.05.084 330K
26.05.043 200R	26.05.085 390K
26.05.044 220R	26.05.086 470K
26.05.045 270R	26.05.087 560K
26.05.046 330R	26.05.088 680K
26.05.047 390R	26.05.089 820K
26.05.048 470R	26.05.090 1M
26.05.049 560R	26.05.091 1M2
26.05.051 680R	26.05.092 1M5
26.05.052 820R	26.05.093 1M8
26.05.054 1K	26.05.094 2M2
26.05.055 1K2	26.05.095 4M7

R\$ 32,30 (PREÇO DO CENTO)

26.05.000 0R10	26.05.007 0R39
26.05.001 0R15	26.05.008 0R47
26.05.002 0R22	26.05.009 0R56
26.05.003 0R24	26.05.010 0R68
26.05.004 0R27	26.05.011 0R75
26.05.005 0R33	26.05.012 0R82
26.05.006 0R36	

26.06.014 1R	26.06.056 1K5
26.06.015 1R2	26.06.057 1K8
26.06.016 1R5	26.06.058 2K2
26.06.017 1R8	26.06.059 2K7
26.06.018 2R2	26.06.060 3K3
26.06.019 2R7	26.06.061 3K9
26.06.020 3R3	26.06.062 4K7
26.06.021 3R9	26.06.063 5K6
26.06.022 4R7	26.06.064 6K8
26.06.023 5R6	26.06.065 8K2
26.06.024 6R8	26.06.066 10K
26.06.025 8R2	26.06.067 12K
26.06.026 10R	26.06.068 15K
26.06.027 12R	26.06.069 18K
26.06.028 15R	26.06.070 22K
26.06.029 18R	26.06.071 27K
26.06.030 22R	26.06.072 33K
26.06.031 27R	26.06.073 39K
26.06.032 33R	26.06.074 47K
26.06.033 39R	26.06.075 56K
26.06.034 47R	26.06.076 68K
26.06.035 56R	26.06.077 82K
26.06.036 62R	26.06.078 100K
26.06.037 68R	26.06.079 120K
26.06.038 82R	26.06.080 150K
26.06.039 100R	26.06.081 180K
26.06.040 120R	26.06.082 220K
26.06.041 150R	26.06.083 270K
26.06.042 180R	26.06.084 330K
26.06.043 200R	26.06.085 390K
26.06.044 220R	26.06.086 470K
26.06.045 270R	26.06.087 560K
26.06.046 330R	26.06.088 680K
26.06.047 390R	26.06.089 820K
26.06.048 470R	26.06.090 1M
26.06.049 560R	26.06.091 1M2
26.06.050 620R	26.06.092 1M5
26.06.051 680R	26.06.093 1M8
26.06.052 820R	26.06.094 2M2
26.06.054 1K	26.06.095 4M7
26.06.055 1K2	

R\$ 49,00 (PREÇO DO CENTO)

26.06.000 0R10	26.06.007 0R39
26.06.001 0R15	26.06.008 0R47
26.06.002 0R22	26.06.009 0R56
26.06.003 0R24	26.06.010 0R68
26.06.004 0R27	26.06.011 0R75
26.06.005 0R33	26.06.012 0R82
26.06.006 0R36	

Resistor 5w Cerâmica Axial

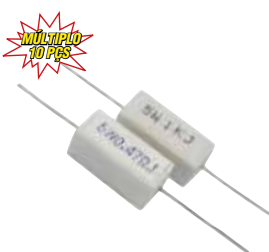

27.09.002 0R22.....	27.09.017 4R7.....	27.09.034 100R.....	27.09.053 2K7.....
27.09.004 0R33.....	27.09.021 10R.....	27.09.035 120R.....	27.09.054 3K3.....
27.09.005 0R47.....	27.09.022 12R.....	27.09.038 220R.....	27.09.056 4K7.....
27.09.009 1R.....	27.09.023 15R.....	27.09.048 1K.....	27.09.057 5K6.....
27.09.011 1R5.....	27.09.024 18R.....	27.09.049 1K2.....	27.09.058 6K8.....
27.09.012 1R8.....	27.09.026 27R.....	27.09.051 1K5.....	27.09.059 8K2.....
27.09.013 2R2.....	27.09.027 33R.....	27.09.052 2K2.....	27.09.060 10K.....
27.09.015 3R3.....	27.09.029 47R.....		

Resistor Fio 5W Axial



27.10.000	0R10
27.10.001	0R15
27.10.002	0R22
27.10.003	0R27
27.10.004	0R33
27.10.061	0R39
27.10.005	0R47
27.10.006	0R75
27.10.007	0R82
27.10.009	1R
27.10.010	1R2
27.10.011	1R5
27.10.012	1R8
27.10.013	2R2
27.10.014	2R7
27.10.015	3R3
27.10.016	3R9
27.10.017	4R7

27.10.018	5R6
27.10.019	6R8
27.10.020	8R2
27.10.021	10R
27.10.022	12R
27.10.023	15R
27.10.024	18R
27.10.025	22R
27.10.026	27R
27.10.027	33R
27.10.028	39R
27.10.029	47R
27.10.030	56R
27.10.032	68R
27.10.033	82R
27.10.034	100R
27.10.035	120R
27.10.036	150R
27.10.037	180R
27.10.038	220R

27.10.039	270R
27.10.040	330R
27.10.041	390R
27.10.042	470R
27.10.043	560R
27.10.045	680R
27.10.046	820R
27.10.048	1K
27.10.049	1K2
27.10.050	1K5
27.10.051	1K8
27.10.052	2K2
27.10.053	2K7
27.10.054	3K3
27.10.055	3K9
27.10.056	4K7
27.10.057	5K6
27.10.058	6K8
27.10.059	8K2
27.10.060	10K

Resistor Fio 10W Axial



27.12.061	0R39
27.12.005	0R47
27.12.009	1R
27.12.010	1R2
27.12.011	1R5
27.12.012	1R8
27.12.013	2R2
27.12.014	2R7
27.12.015	3R3
27.12.016	3R9
27.12.017	4R7
27.12.018	5R6
27.12.019	6R8
27.12.020	8R2
27.12.021	10R
27.12.022	12R
27.12.023	15R

27.12.024	18R
27.12.025	22R
27.12.026	27R
27.12.027	33R
27.12.028	39R
27.12.029	47R
27.12.030	56R
27.12.032	68R
27.12.033	82R
27.12.034	100R
27.12.035	120R
27.12.036	150R
27.12.037	180R
27.12.038	220R
27.12.039	270R
27.12.040	330R
27.12.041	390R
27.12.042	470R
27.12.043	560R

27.12.045	680R
27.12.046	820R
27.12.048	1K
27.12.049	1K2
27.12.050	1K5
27.12.051	1K8
27.12.052	2K2
27.12.053	2K7
27.12.054	3K3
27.12.055	3K9
27.12.056	4K7
27.12.057	5K6
27.12.058	6K8
27.12.059	8K2
27.12.060	10K
27.12.062	12K
27.12.063	15K
27.12.064	18K
27.12.065	22K

Resistor 10W Axial Porcelana - SQP/10 Óxido Metal



27.13.004	0R33
27.13.009	1R
27.13.011	1R5
27.13.012	1R8
27.13.013	2R2
27.13.014	2R7
27.13.015	3R3
27.13.016	3R9

27.13.017	4R7
27.13.021	10R
27.13.022	12R
27.13.023	15R
27.13.024	18R
27.13.025	22R
27.13.026	27R
27.13.027	33R
27.13.028	39R
27.13.029	47R
27.13.034	100R
27.13.035	120R

27.13.036	150R
27.13.037	180R
27.13.038	220R
27.13.040	330R
27.13.048	1K
27.13.052	2K2
27.13.055	3K9
27.13.056	4K7
27.13.057	5K6
27.13.060	10K
27.13.063	15K

Resistor 20W Axial Especial Porcelana

29.08.058
RESISTOR 20 W AXIAL 15R

Resistor Fio 20w Axial

27.16.023
RESISTOR FIO 20 W AXIAL ESPECIAL 15R

Todos os nomes, logotipos de empresas e produtos citados neste catálogo são marcas registradas de suas respectivas corporações. A citação dos mesmos tem a única intenção de auxiliar nossos clientes na identificação de nossos produtos que são compatíveis com os originais.

**RESISTOR CARBONO SMD
1/16W (1,6X0,8X0,5) 0603
(PREÇO DO CENTO)**

26.09.040	330R
26.09.045	680R
26.09.048	1K
26.09.054	3K3
26.09.056	4K7
26.09.057	5K6
26.09.060	10K
26.09.068	47K
26.09.071	82K
26.09.078	330K
26.09.082	680K
26.09.083	820K
26.09.090	5M6

**RESISTOR CARBONO SMD
1/8W (2X1,2X0,5) 0805
(PREÇO DO CENTO)**

26.11.008	1R
26.11.020	10R
26.11.024	22R
26.11.026	33R
26.11.028	47R
26.11.033	100R
26.11.035	150R
26.11.038	220R
26.11.040	330R
26.11.041	390R
26.11.042	470R
26.11.043	560R
26.11.044	620R
26.11.045	680R
26.11.046	820R
26.11.048	1K
26.11.049	1K2
26.11.050	1K5
26.11.051	1K8
26.11.052	2K2
26.11.053	2K7
26.11.054	3K3
26.11.056	4K7
26.11.057	5K6
26.11.058	6K8
26.11.059	8K2
26.11.060	10K
26.11.061	12K

**RESISTOR CARBONO SMD
1/8W (2X1,2X0,5) 0805
(PREÇO DO CENTO)**

26.11.062	15K
26.11.063	18K
26.11.064	22K
26.11.065	27K
26.11.066	33K
26.11.067	39K
26.11.068	47K
26.11.069	56K
26.11.070	68K
26.11.071	82K
26.11.072	100K
26.11.073	120K
26.11.074	150K
26.11.075	180K
26.11.076	220K
26.11.078	330K
26.11.080	470K
26.11.081	560K
26.11.082	680K
26.11.083	820K
26.11.084	1M
26.11.085	1M2
26.11.086	1M5
26.11.088	2M2
26.11.089	4M7
26.11.090	5M6

**RESISTOR CARBONO SMD
1/4W (3,2X1,6X0,55) 1206
(PREÇO DO CENTO)**

26.10.008	1R
26.10.011	1R8
26.10.020	10R
26.10.024	22R
26.10.026	33R
26.10.031	68R
26.10.033	100R
26.10.038	220R
26.10.042	470R
26.10.046	820R
26.10.048	1K
26.10.049	2K2
26.10.053	2K7
26.10.054	3K3
26.10.056	4K7
26.10.059	8K2
26.10.060	10K
26.10.064	22K
26.10.066	33K
26.10.068	47K
26.10.072	100K
26.10.076	220K
26.10.088	2M2

Rede Resistiva Carbono



8+1= 9 PINO S

26.12.033 100R	26.12.052 2K2	26.12.066 33K
26.12.038 220R	26.12.061 12K	26.12.068 47K
26.12.040 330R	26.12.064 22K	26.12.077 220K
26.12.048 1K		26.12.081 470K
		26.12.085 1M



CAP. CER. DISCO 50V

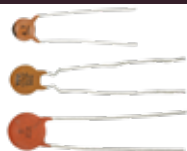

(PREÇO CENTO)

06.00.000 1PF
06.00.002 1PF5
06.00.004 1PF8
06.00.066 3PF3
06.00.068 6PF8
06.00.037 10PF
06.00.070 15PF
06.00.071 18PF
06.00.072 22PF
06.00.073 27PF
06.00.074 33PF
06.00.075 39PF
06.00.076 47PF
06.00.077 56PF
06.00.038 68PF
06.00.079 82PF
06.00.039 100PF
06.00.040 120PF
06.00.041 150PF
06.00.042 180PF
06.00.043 220PF
06.00.044 270PF
06.00.045 330PF
06.00.046 390PF
06.00.047 470PF
06.00.048 560PF
06.00.050 680PF
06.00.053 1K PF
06.00.055 1K5PF
06.00.057 2K2PF
06.00.058 2K7PF
06.00.059 3K3PF
06.00.060 3K9PF
06.00.061 4K7PF
06.00.063 22KPF
06.00.062 10KPF
06.00.064 47KPF
06.00.065 100KPF

06.01.021 4K7 PF X 2KV
06.01.023 10K X 1KV

CAP. CER. DISCO POLYESTER ESPECIAL



06.02.001 330PF X 2KV
06.02.002 470PF X 2KV
06.02.003 1K5PF X 2KV
06.02.005 2K2PF X 1KV
06.02.006 2K2PF X 2KV
06.02.008 4K7PF X 400V
06.02.012 10KPF X 2KV
06.02.010 10KPF X 400V
06.02.011 10KPF X 500V
06.02.020 15K X 1KV

CAP. ELETR. 105º RADIAL



07.02.092 1 MF X 50V
07.02.094 1 MF X 100V
07.02.188 1 MF X 200V
07.02.095 1 MF X 250V
07.02.058 1 MF X 350V
07.02.097 2,2 MF X 50V
07.02.099 2,2 MF X 100V
07.02.001 2,2 MF X 160V
07.02.100 2,2 MF X 250V
07.02.102 3,3 MF X 50V
07.02.104 3,3 MF X 100V
07.02.106 3,3 MF X 400V
07.02.003 6,8 MF X 350V
07.02.004 6,8 MF X 400V
07.02.107 4,7 MF X 50V
07.02.108 4,7 MF X 63V
07.02.109 4,7 MF X 100V
07.02.110 4,7 MF X 160V
07.02.111 4,7 MF X 250V
07.02.189 4,7 MF X 350V
07.02.196 4,7 MF X 400V
07.02.190 4,7 MF X 450V
07.02.113 10 MF X 25V
07.02.114 10 MF X 35V
07.02.115 10 MF X 50V
07.02.116 10 MF X 63V
07.02.117 10 MF X 100V
07.02.118 10 MF X 160V
07.02.119 10 MF X 250V
07.02.059 10 MF X 350V
07.02.061 10 MF X 400V
07.02.062 10 MF X 450V
07.02.123 22 MF X 50V
07.02.124 22 MF X 63V
07.02.125 22 MF X 100V
07.02.006 22 MF X 160V
07.02.008 22 MF X 250V
07.02.205 27 MF X 400V
07.02.129 33 MF X 16V
07.02.208 33 MF X 50V

CAP ELETR SMD



07.06.000 1UF X 50V
07.06.014 4,7UF X 16V
07.06.024 10UF X 16V
07.06.055 47UF X 6,3V
07.06.056 47UF X 16V
07.06.057 47UF X 25V
07.06.073 100UF X 4V
07.06.074 100UF X 6,3V
07.06.076 100UF X 16V
07.06.077 100UF X 25V
07.06.094 220UF X 25V
07.06.095 220UF X 35V
07.06.106 330UF X 25V CANECA 10X10
07.06.107 330UF X 25V CANECA 8X10
07.06.111 470UF X 16V
07.06.126 1000UF X 10V

CAP. CER. DISCO ALTA ISOLAÇÃO

06.01.004 150 PF X 2KV
06.01.005 220 PF X 1KV
06.01.006 220 PF X 2KV
06.01.008 330 PF X 1KV
06.01.009 470 PF X 500V
06.01.011 680 PF X 2KV
06.01.013 820 PF X 500 V
06.01.016 1 K PF X 1KV
06.01.017 1K PF X 2KV
06.01.015 1K PF X 500V
06.01.020 2K2 PF X 500V

Todos os nomes, logotipos de empresas e produtos citados neste catálogo são marcas registradas de suas respectivas corporações. A citação dos mesmos tem a única intenção de auxiliar nossos clientes na identificação de nossos produtos que são compatíveis com os originais.

07.02.009	33 MF X 160V
07.02.010	33 MF X 200V
07.02.011	33 MF X 250V
07.02.065	33 MF X 400V
07.02.209	47 MF X 16V
07.02.140	47 MF X 35V
07.02.139	47 MF X 25V
07.02.141	47 MF X 50V
07.02.142	47 MF X 63V
07.02.143	47 MF X 100V
07.02.013	47 MF X 160V
07.02.066	47 MF X 250V
07.02.014	47 MF X 350V
07.02.015	47 MF X 400V
07.02.068	47 MF X 450V
07.02.016	68 MF X 200V
07.02.210	68 MF X 450V
07.02.207	100 MF X 10V
07.02.187	100 MF X 16V
07.02.146	100 MF X 25V
07.02.017	100 MF X 35V
07.02.148	100 MF X 50V
07.02.149	100 MF X 63V
07.02.150	100 MF X 100V
07.02.152	100 MF X 250V
07.02.069	100 MF X 400V
07.02.019	120 MF X 10V
07.02.020	120 MF X 25V
07.02.021	120 MF X 100V

07.02.211	120 MF X 450V
07.02.022	150 MF X 10V
07.02.071	220 MF X 10V
07.02.202	220 MF X 16V
07.02.154	220 MF X 25V
07.02.155	220 MF X 35V
07.02.023	220 MF X 50V
07.02.157	220 MF 63V
07.02.024	220 MF X 100V
07.02.072	220 MF X 250V
07.02.194	330 MF X 10V
07.02.025	330 MF X 16V
07.02.026	330 MF X 25V
07.02.159	330 MF X 35V
07.02.206	470 MF X 10V
07.02.029	470 MF X 16V
07.02.074	470 MF X 25V
07.02.164	470 MF X 35V
07.02.203	470 MF X 50V
07.02.166	470 MF X 63V
07.02.030	470 MF X 200V

07.02.032	680 MF X 10V
07.02.033	680 MF X 16V
07.02.201	680 MF X 50V
07.02.035	820 MF X 16V
07.02.037	820 MF X 35V
07.02.039	1 000 MF X 10V
07.02.040	1 000 MF X 16V
07.02.041	1 000 MF X 25V
07.02.042	1 000 MF X 35V
07.02.170	1 000 MF X 50V
07.02.044	1 200 MF X 6,3V
07.02.045	1 200 MF X 10V
07.02.195	1 200 MF X 16V
07.02.046	1 500 MF X 6,3V
07.02.050	2 200 MF X 10V
07.02.051	2 200 MF X 16V
07.02.172	2 200 MF X 25V
07.02.173	2 200 MF X 35V
07.02.174	2 200 MF X 50V
07.02.075	2 200 MF X 63V
07.02.052	2 700 MF X 6,3V
07.02.054	3 300 MF X 10V
07.02.055	3 300 MF X 16V
07.02.176	3 300 MF X 25V
07.02.178	3 300 MF X 50V
07.02.056	4 700 MF X 6,3V
07.02.182	4 700 MF X 35V
07.02.183	4 700 MF X 50V
07.02.184	4 700 MF X 63V



07.02.070
CAP. ELETROLITICO 105° 470UF X 250V

CAP. ELETR. MINI

07.04.007	2,2UF X 50V
07.04.017	10F X 50V

07.01.016	1UF 100V
07.01.018	1UF 200V
07.01.019	1UF 250V
07.01.020	1UF 350V
07.01.022	2.2UF 50V
07.01.025	2.2UF 100V
07.01.029	2.2UF 350V
07.01.031	3.3UF 63V
07.01.033	3.3UF 100V
07.01.034	3.3UF 250V
07.01.035	3.3UF 350V
07.01.044	4.7UF 250V
07.01.052	10 UF 25V
07.01.070	22UF 50V
07.01.083	33UF 25V

07.01.084	33UF 50V
07.01.085	33UF 63V
07.01.086	33UF 100V
07.01.089	33UF 450V
07.01.096	47UF 25V
07.01.099	47UF 100V
07.01.111	68UF 250V
07.01.122	100UF 10V
07.01.131	100UF 160V
07.01.148	220UF 16V
07.01.149	220UF 25V
07.01.153	220UF 100V
07.01.239	220UF 200V
07.01.161	270UF 160V
07.01.164	330UF 10V
07.01.165	330UF 16V
07.01.171	330UF 400V
07.01.174	470UF 6.3V



07.01.240	470UF 10V
07.01.184	470UF 250V
07.01.187	470UF 400V "GARRA"
07.01.207	3 300UF 25V
07.01.209	3 300UF 50V
07.01.238	3 300UF 65V
07.01.211	4 700UF 16V

Cap. Polipropileno



**ALGUNS ITENS
PODERÃO SER
SUBSTITUÍDOS
POR 400V**

ISOLAÇÃO 250V

- 08.00.000 1,5MF
- 08.00.001 2 MF
- 08.00.002 2,5MF
- 08.00.003 3 MF
- 08.00.004 3,5MF
- 08.00.005 4 MF
- 08.00.006 4,5 MF
- 08.00.008 5 MF
- 08.00.009 5,5MF
- 08.00.010 6 MF
- 08.00.011 6,5MF
- 08.00.012 7 MF
- 08.00.013 7,5MF
- 08.00.014 8 MF
- 08.00.015 8,5MF
- 08.00.016 9 MF
- 08.00.017 9,5MF
- 08.00.018 10 MF
- 08.00.019 11 MF
- 08.00.020 12 MF
- 08.00.021 13 MF
- 08.00.022 14 MF
- 08.00.023 15 MF
- 08.00.024 16 MF
- 08.00.025 17 MF
- 08.00.026 18 MF
- 08.00.027 19 MF
- 08.00.028 20 MF
- 08.00.029 22 MF
- 08.00.030 24 MF
- 08.00.031 25 MF
- 08.00.032 30 MF
- 08.00.033 35 MF
- 08.00.034 40 MF
- 08.00.035 45 MF
- 08.00.036 50 MF
- 08.00.037 55 MF
- 08.00.038 60 MF
- 08.00.039 65 MF
- 08.00.040 70 MF
- 08.00.041 75 MF
- 08.00.042 80 MF
- 08.00.044 90 MF
- 08.00.045 95 MF
- 08.00.046 100 MF

ISOLAÇÃO 330V

- 08.01.000 2 MF
- 08.01.003 5 MF
- 08.01.005 6 MF

ISOLAÇÃO 380V

- 08.02.000 2 MF
- 08.02.001 3 MF
- 08.02.002 4 MF
- 08.02.003 5 MF
- 08.02.004 6 MF

- 08.02.005 7 MF
- 08.02.006 8 MF
- 08.02.007 9 MF
- 08.02.008 10 MF
- 08.02.009 12 MF
- 08.02.010 15 MF
- 08.02.012 18 MF
- 08.02.013 20 MF
- 08.02.014 22 MF
- 08.02.015 25 MF
- 08.02.016 30 MF
- 08.02.017 35 MF
- 08.02.018 40 MF
- 08.02.019 45 MF
- 08.02.020 60 UF
- 08.02.021 80 MF

ISOLAÇÃO 440V

- 08.04.000 2 MF
- 08.04.001 3 MF
- 08.04.002 4 MF
- 08.04.003 5 MF
- 08.04.004 6 MF
- 08.04.005 7 MF
- 08.04.006 8 MF
- 08.04.007 10 MF
- 08.04.008 12 MF
- 08.04.009 15 MF
- 08.04.010 20 MF
- 08.04.011 25 UF
- 08.04.012 30 MF
- 08.04.013 35 MF
- 08.04.014 40 MF
- 08.04.015 45 MF
- 08.04.016 60 MF

ISOLAÇÃO 3 FIOS 250V

- 08.06.000 1 MF + 2 MF
- 08.06.002 1 MF + 2,5MF
- 08.06.003 1 MF + 2,7MF
- 08.06.004 1 MF + 3 MF
- 08.06.005 1,2MF + 2 MF
- 08.06.006 1,2MF + 2,3MF
- 08.06.007 1,2MF + 2,5MF
- 08.06.008 1,2MF + 2,7MF
- 08.06.009 1,2MF + 3 MF
- 08.06.027 1,3MF + 1,7MF
- 08.06.010 1,3MF + 2,7MF
- 08.06.011 1,5 MF + 2 MF
- 08.06.012 1,5MF + 2,3MF
- 08.06.013 1,5MF + 2,5MF
- 08.06.014 1,5MF + 2,7MF
- 08.06.015 1,5MF + 3 MF
- 08.06.016 2 MF + 3 MF
- 08.06.017 2 MF + 3,5MF
- 08.06.018 2 MF + 4 MF
- 08.06.019 2 MF + 4,5MF
- 08.06.020 2,5MF + 3 MF
- 08.06.021 2,5MF + 3,5MF
- 08.06.022 2,5MF + 4 MF
- 08.06.023 2,5MF + 4,5MF

- 08.06.024 3 MF + 7 MF
- 08.06.025 4 MF + 6 MF
- 08.06.029 4 MF + 8 MF
- 08.06.026 5 MF + 7,5MF
- 08.06.036 0,70UF X 0,90UF X 400V

TERMINAL FASTON



- 08.07.009 10UF X 250V
- 08.07.010 12UF X 250V
- 08.07.011 15UF X 250V
- 08.07.015 20UF X 250V
- 08.07.018 25UF X 250V
- 08.07.019 30UF X 250V
- 08.07.020 35UF X 250V
- 08.07.021 40UF X 250V
- 08.07.022 45UF X 250V
- 08.08.000 2UF X 380V
- 08.08.001 3UF X 380V
- 08.08.002 4UF X 380V
- 08.08.003 5UF X 380V
- 08.08.004 6UF X 380V
- 08.08.005 7UF X 380V
- 08.08.006 8UF X 380V
- 08.08.008 10UF X 380V
- 08.08.009 12UF X 380V
- 08.08.012 15UF X 380V
- 08.08.015 18UF X 380V
- 08.08.016 20UF X 380V
- 08.08.018 25UF X 380V
- 08.08.019 30UF X 380V
- 08.08.020 35UF X 380V
- 08.08.021 40UF X 380V
- 08.08.022 45UF X 380V
- 08.08.023 50UF X 380V
- 08.08.024 60UF X 380V
- 08.09.000 2UF X 440V
- 08.09.001 3UF X 440V
- 08.09.002 4UF X 440V
- 08.09.003 5UF X 440V
- 08.09.004 6UF X 440V
- 08.09.005 7UF X 440V
- 08.09.006 8UF X 440V
- 08.09.008 10UF X 440V
- 08.09.009 12UF X 440V
- 08.09.012 15UF X 440V
- 08.09.015 18UF X 440V
- 08.09.016 20UF X 440V
- 08.09.018 25UF X 440V
- 08.09.019 30UF X 440V
- 08.09.020 35UF X 440V
- 08.09.021 40UF X 440V
- 08.09.022 45UF X 440V
- 08.09.023 50UF X 440V
- 08.09.024 60UF X 440V

Cap. Polyester CBB61 - Retangular Fio



- 08.10.017 1,5UF X 250V.....
- 08.10.018 2UF X 250V.....
- 08.10.019 2,5UF X 250V.....
- 08.10.020 3UF X 250V.....
- 08.10.025 12UF X 250V.....
- 08.11.000 3 FIOS 0,70UF X 0,90 X 400V
- 08.11.001 3 FIOS 1,5UF X 2,5UF X 400V ...

- 08.10.014 1UF X 450V.....
- 08.10.000 1,5UF X 450V.....
- 08.10.001 2UF X 450V.....
- 08.10.006 2,5UF X 450V.....
- 08.10.002 3UF X 450V.....
- 08.10.015 3,5UF X 450V.....
- 08.10.003 4UF X 450V.....
- 08.10.004 5UF X 450V.....
- 08.10.005 6UF X 450V.....

Cap. Polyester CBB61 - Retangular Term. Faston



- 08.10.007 1.5UF X 450V
- 08.10.008 2UF X 450V
- 08.10.009 2.5UF X 450V
- 08.10.010 3UF X 450V
- 08.10.011 4UF X 450V
- 08.10.012 5UF X 450V
- 08.10.013 6UF X 450V

Cap. Polyester

ESPECIAL P/ TWEETER S - MÉDIOS DRIVERS E OUTROS

- 09.00.030 250V 1 MPF
- 09.00.031 400V 1 MPF
- 09.00.033 250V 2M2.....
- 09.00.034 400V 2M2.....

- 09.00.035 250V 3M3.....
- 09.00.036 250V 4M7.....
- 09.00.041 250V 6M8.....

100V

- 09.00.019 47K.....
- 09.00.001 2,2KPF.....
- 09.00.021 68K.....
- 09.00.012 8K2.....

- 09.00.098 56K.....
- 09.00.102 68K.....
- 09.00.023 100K.....
- 09.00.025 220K.....
- 09.00.108 330K.....

- 09.00.107 220K.....
- 09.00.109 330K.....
- 09.00.110 470K.....
- 09.00.113 560K.....
- 09.00.115 680K.....
- 09.00.116 1UF.....

250V

- 09.00.065 5K6.....
- 09.00.014 10K.....
- 09.00.085 22K.....
- 09.00.090 33K.....
- 09.00.020 47K.....
- 09.00.097 56K.....
- 09.00.101 68K.....
- 09.00.022 100K.....
- 09.00.024 220K.....
- 09.00.026 330K.....
- 09.00.027 470K.....
- 09.00.111 560K.....
- 09.00.029 680K.....

- 09.00.028 470K.....
- 09.00.112 560K.....
- 09.00.114 680K.....
- 09.00.031 1UF.....
- 09.00.118 1,5UF.....
- 09.00.122 820K X 500V
- 09.00.120 12K X 1000V.....

1000V

- 09.00.120 12K.....

1600V

- 09.00.046 1K.....
- 09.00.048 1K5.....
- 09.00.052 2K7.....
- 09.00.057 3K3.....
- 09.00.058 3K9.....
- 09.00.006 4K7 PF.....
- 09.00.007 5K6.....
- 09.00.008 6K2 PF.....
- 09.00.010 6K8.....
- 09.00.073 7K1.....
- 09.00.074 7K5.....
- 09.00.075 8K2.....
- 09.00.078 10K.....
- 09.00.080 12K.....
- 09.00.093 33K.....
- 09.00.096 47K.....
- 09.00.100 56K.....
- 09.00.104 68K.....
- 09.00.106 100K.....

630V

- 09.00.047 1K5.....
- 09.00.051 2K2.....
- 09.00.056 3K3.....
- 09.00.061 4K7.....
- 09.00.067 5K6.....
- 09.00.071 6K8.....
- 09.00.016 10K.....
- 09.00.082 15K.....
- 09.00.084 18K.....
- 09.00.087 22K.....
- 09.00.092 33K.....
- 09.00.095 47K.....
- 09.00.099 56K.....
- 09.00.103 68K.....
- 09.00.105 100K.....

400V

- 09.00.050 2K2.....
- 09.00.066 5K6.....
- 09.00.015 10K.....
- 09.00.086 22K.....
- 09.00.089 27K.....
- 09.00.091 33K.....
- 09.00.094 47K.....

Todos os nomes, logotipos de empresas e produtos citados neste catálogo são marcas registradas de suas respectivas corporações. A citação dos mesmos tem a única intenção de auxiliar nossos clientes na identificação de nossos produtos que são compatíveis com os originais.

Cap. Poliester Supressor

Cap. Eletr. Bipolar Radial



- 09.04.002 68K X 275 VAC.....
- 09.04.000 100K X 275 VAC.....
- 09.04.006 470K X 275VAC.....

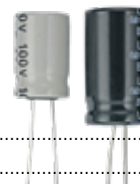

- 07.03.016 22 MF X100V.....
- 07.03.012 47 MF X 100V.....
- 07.03.010 100 MF X 100V.....
- 07.03.011 220 MF X 100V.....

Circuito Integrado



11.00.007 4N25 = TIL

- 11.00.008 4N26
- 11.00.009 4N33
- 11.00.010 4N35
- 11.00.012 5M0165 R
- 11.00.013 5M0265 R
- 11.00.016 5M02659 R - DIP 8 PINOS
- 11.00.014 5M0365 R 4 PINOS
- 11.00.015 5M0365 R 8 PINOS
- 11.00.017 6N135
- 11.00.018 6N136
- 11.00.019 6N137
- 11.00.020 6N139
- 11.99.019 25L1606E

11.99.059 70035 AB = TDA 1519 C

- 11.01.064 A 6151

11.99.038 AD 6548 BCP2 SMD

11.01.030 AM 2088 AT

- 11.01.031 AM 5868 S SMD
- 11.01.005 AN 5150
- 11.01.006 AN 5151 N
- 11.01.036 AN 5163 K
- 11.01.037 AN 5165 K
- 11.01.038 AN 5179
- 11.01.039 AN 5270
- 11.01.010 AN 5512
- 11.01.040 AN 5539
- 11.01.014 AN 5625
- 11.01.042 AN 5836
- 11.01.044 AN 6651
- 11.01.046 AN 7125 = AN 17820
- 11.01.020 AN 7135
- 11.01.047 AN 7142
- 11.01.048 AN 7148
- 11.01.049 AN 7149 N
- 11.01.023 AN 7164
- 11.01.024 AN 7168
- 11.01.025 AN 7171 K
- 11.01.052 AN 7312
- 11.01.053 AN 7323
- 11.01.054 AN 7522 N - ORIGINAL
- 11.01.055 AN 7523 N
- 11.01.056 AN 7591
- 11.01.058 AN 15525 A
- 11.01.059 AN 15526
- 11.01.065 AN 17820 A
- 11.01.061 AN 17821 A
- 11.01.062 AN 17830 A
- 11.01.066 AN 17831
- 11.01.063 AN 17850 A
- 11.01.032 AN 80T07

- 11.01.033 AN 80T51

- 11.01.034 AN 80T54 A

11.99.039 AT 25DF321 SMD

- 11.03.015 BA 3426 AS
- 11.03.016 BA 3570 SMD
- 11.03.004 BA 3822
- 11.03.017 BA 3834 F SMD
- 11.03.018 BA 3834 LS
- 11.03.020 BA 4905
- 11.03.021 BA 4911
- 11.03.022 BA 5414
- 11.03.023 BA 5415
- 11.03.024 BA 5417
- 11.03.025 BA 5939 S

- 11.03.027 BA 5954 SMD

- 11.03.028 BA 5974 SMD

- 11.03.029 BA 5984 FP SMD

- 11.03.030 BA 5985 SMD

- 11.03.031 BA 5996 SMD

- 11.03.007 BA 6209

11.99.009 BA 6219 B

- 11.03.033 BA 6238
- 11.03.009 BA 6247
- 11.03.036 BA 6396 SMD
- 11.03.039 BA 6411
- 11.03.040 BA 7765
- 11.03.041 BA 7767 AS

11.03.043 BA 49182

11.03.044 BD 45292G - V30T43 SMD 5 PINOS

11.03.045 BD 49131

- 11.04.010 CA 555/LM 555 /NE 555
- 11.04.009 CA 555/NE 555 SMD
- 11.04.011 CA 741/LM 741/ UA 741
- 11.04.012 CA 1310 E
- 11.04.013 CA 3080
- 11.05.000 CD 4001 BE
- 11.05.015 CD 4011
- 11.05.001 CD 4013
- 11.05.003 CD 4021
- 11.05.016 CD 4030
- 11.05.017 CD 4040
- 11.05.007 CD 4046
- 11.05.008 CD 4049
- 11.05.018 CD 4051
- 11.05.019 CD 4052
- 11.05.020 CD 4053
- 11.05.010 CD 4053 - SMD RETANGULAR
- 11.05.021 CD 4066 GDE
- 11.05.022 CD 4070

- 11.05.023 CD 4081

- 11.05.024 CD 4093

- 11.05.013 CD 4094

- 11.05.025 CD 4511

- 11.05.014 CD 40106

- 11.08.003 DBL 1032 D

11.99.040 DE 1108 AGBG 1J SMD

- 11.08.005 DH 321
- 11.08.002 DL 0165 R
- 11.08.007 DM 0265 R
- 11.08.008 DM 0365 R
- 11.08.006 DM 311
- 11.08.009 DP 104 C
- 11.08.010 DP 704
- 11.08.011 DP 804
- 11.08.012 DP 904

- 11.08.016 DS 1669 S-10 SOIC 8 SMD

11.99.020 ET 6202 SMD

- 11.08.013 FA 5311

11.08.017 FA 5571 SMD

11.99.041 FDS 9435A SMD

11.08.015 FSQ 510

11.99.021 H27U 1G8F2 BTR MEM FHASH

- 11.09.007 HA 1377
- 11.09.009 HA 11235
- 11.09.011 HA 11545
- 11.09.017 HA 13151
- 11.09.019 HA 13155
- 11.09.020 HA 13158
- 11.09.021 HA 13164
- 11.09.022 HD 404316A91 S
- 11.10.004 HM 9102
- 11.10.005 HT 1000-4 SMD
- 11.10.006 HT 1200-4 SMD
- 11.10.007 ICE 1QS01
- 11.10.010 ICE 2B0565
- 11.10.011 ICE 3B0365 J
- 11.10.012 ICE 3B2065 J - DIP-8
- 11.10.031 ICL 7107
- 11.10.016 ICPN 10
- 11.10.017 ICPN 15
- 11.10.018 ICPN 20
- 11.10.019 ICPN 25
- 11.10.020 ICPN 38
- 11.10.024 IR 2010 DIP
- 11.10.025 IR 2010 SMD
- 11.10.026 IR 2110 DIP
- 11.10.027 IR 2110 SMD
- 11.10.028 IR 2111 DIP
- 11.10.029 IR 4427 DIP

- 11.10.030 IR 4427 SMD

- 11.11.021 KA 2133

- 11.11.022 KA 2142

- 11.11.023 KA 2154

- 11.11.031 KA 2206 B

- 11.11.018 KA 2209

- 11.11.024 KA 2250

- 11.11.027 KA 2912

- 11.11.029 KA 9258 D SMD

- 11.11.030 KA 9259 D SMD

11.99.022 KIA 2431AP (FORMATO BC)

- 11.12.006 KIA 6227

- 11.12.007 KIA 6282

- 11.12.005 KIA 6283

- 11.12.008 KIA 6289

- 11.12.009 KIA 7227

11.12.010 KKZ 10

- 11.15.002 L 298 N

- 11.99.016 L 808 ABV

11.99.014 L 4931 - ABV33

- 11.15.003 L 4959

- 11.15.014 L 4960

11.99.023 L 6563 SMD

- 11.15.004 L 6565

11.14.090 LA 1140

- 11.14.000 LA 1186
- 11.14.086 LA 1835
- 11.14.006 LA 3361
- 11.14.089 LA 3607
- 11.14.009 LA 4182
- 11.14.010 LA 4192
- 11.14.033 LA 4225
- 11.14.034 LA 4227
- 11.14.036 LA 4261
- 11.14.012 LA 4265
- 11.14.013 LA 4270
- 11.14.039 LA 4282
- 11.14.014 LA 4285
- 11.14.017 LA 4446
- 11.14.087 LA 4485
- 11.14.020 LA 4508
- 11.14.021 LA 4550
- 11.14.022 LA 4597
- 11.14.043 LA 4598
- 11.14.045 LA 4628
- 11.14.046 LA 4630
- 11.14.047 LA 4705 N
- 11.14.048 LA 4743 B
- 11.14.049 LA 4743 J
- 11.14.051 LA 7374

Todos os nomes, logotipos de empresas e produtos citados neste catálogo são marcas registradas de suas respectivas corporações. A citação dos mesmos tem a única intenção de auxiliar nossos clientes na identificação de nossos produtos que são compatíveis com os originais.

11.14.052 LA 7393 A
 11.14.028 LA 7520
 11.14.053 LA 7620
 11.14.029 LA 7680
 11.14.056 LA 7685 N
 11.14.057 LA 7687 N
 11.14.058 LA 7830
 11.14.059 LA 7833
 11.14.060 LA 7837
 11.14.061 LA 7838
 11.14.062 LA 7840
 11.14.063 LA 7841
 11.14.064 LA 7845
 11.14.066 LA 7848
 11.14.069 LA 9210 SMD
 11.14.070 LA 9240 SMD
 11.14.071 LA 42051
 11.14.072 LA 42072 N
 11.14.073 LA 42102
 11.14.074 LA 42152
 11.14.031 LA 42205
 11.14.075 LA 42352
 11.14.076 LA 47505
 11.14.077 LA 47515
 11.14.078 LA 47516
 11.14.091 LA 72700 SMD
 11.14.079 LA 76930 N-7L
 11.14.081 LA 76931 A-7L
 11.14.082 LA 76933 7L
 11.14.083 LA 78040 B
 11.14.084 LA 78041
 11.14.085 LA 78045
 11.14.088 LA 78141
 11.15.005 LB 1423
 11.15.015 LB 1641
11.99.025 LD 1117 512TR
11.99.026 LD 1117 525TR
11.99.024 LD 29150
 11.15.008 LF 347
 11.15.009 LF 351
 11.15.010 LF 353
 11.15.011 LF 356
 11.16.047 LM 19
 11.16.016 LM 35 DZ
 11.16.017 LM 301 AN
 11.16.018 LM 311 - 8 PINOS
 11.16.019 LM 317 LZ
 11.16.020 LM 317 T
 11.16.021 LM 324
 11.16.046 LM 324 - SMD
 11.16.022 LM 339 N
 11.16.023 LM 358 N
 11.16.024 LM 380 8 PINOS
 11.16.025 LM 386
 11.16.001 LM 393
 11.16.002 LM 723
 11.16.026 LM 1203 N
 11.16.027 LM 2437 T
 11.16.028 LM 2438 T
 11.16.029 LM 2439 T
 11.16.031 LM 2468 TA
 11.16.032 LM 2475 T
 11.16.050 LM 2576 T
11.16.049 LM 2596 T
 11.16.034 LM 2901 ND
 11.16.035 LM 2902
 11.16.036 LM 2903
 11.16.037 LM 2904 N

11.16.038 LM 3876 T METAL
 11.16.039 LM 3886 TF
 11.16.040 LM 3914
 11.16.041 LM 3915 N
 11.16.042 LM 4765 T METAL
 11.16.048 LM 4863 S - SMD
 11.16.043 LM 7000
 11.16.044 LM 7001
 11.16.045 LM 13700
 11.15.018 LNK 304 PN
 11.15.019 LNK 306 PN - DIP
 11.15.016 LNK 362
 11.15.017 LNK 364 PN
 11.17.001 LV 47004
 11.18.009 M 37272 M8-194 SP
 11.18.011 M 50433 232 SP
 11.18.012 M 52707 SP
 11.18.013 M 52770 SP
 11.19.036 MAX 232 N
 11.19.135 MB 3756
 11.19.037 MC 1374 P
 11.19.038 MC 1458 N
 11.19.039 MC 1488
 11.19.033 MC 33152 SMD
 11.19.031 MC 34063
 11.19.041 MC 44603 AP
 11.19.042 MC 44603 P
11.99.027 MC 908QY 1AC
 11.19.043 MC 145026
 11.19.044 MC 145028
 11.19.138 MC 33063 AP1 - 8 PINOS
 11.19.048 MOC 3010
 11.19.049 MOC 3011
 11.19.050 MOC 3020
 11.19.051 MOC 3021
 11.19.052 MOC 3022
 11.19.053 MOC 3023
 11.19.054 MOC 3041
 11.19.055 MOC 3042
 11.19.056 MOC 3043
 11.19.058 MOC 3062
 11.19.059 MOC 3063
 11.19.060 MOC 3081
 11.19.061 MOC 3083
 11.19.063 MSM 80011 A - DIP
 8 PINOS
 11.19.065 MSP 3425 GB 8 V3
 11.99.051 MT 1389DX SMD
11.99.043 MT 5363 BIMG
MICROPROCESSADOR
 11.19.066 MT 8870 DIP
11.90.074 MX 25L 1606E
MEMÓRIA SMD 8 PINOS
 11.19.067 NCP 1200 AP60G
 11.19.068 NCP 1207 SMD
 11.19.069 NE 545
 11.19.071 NE 592 N- 8 PINOS
 11.19.072 NE 592 N-14 PINOS
 11.19.032 NE 5517 SMD
 11.19.137 OB 2268 CP
11.99.054 OZ 9926 AGN SMD
11.99.028 OZ 9976 GN SMD
 11.19.076 PAL 003
 11.19.077 PAL 006
 11.19.078 PAL 007 A
 11.19.079 PAL 008
 11.19.080 PC 120
 11.19.081 PC 814

11.19.082 PC 817
 11.19.084 PCF 8582 E-2
11.99.049 PHD 38N 02
 11.19.085 PIC 12C508A- 04/P
 11.19.086 PIC 12C509A- 04/P
 11.19.087 PIC 12F629 I/P
 11.19.088 PIC 12F675 I/P
 11.19.089 PIC 16C 54C 04/P
 11.19.091 PIC 16C 57C 04/P
 11.19.092 PIC 16C711 04/P
 11.19.093 PIC 16F 73 I/SP
 11.19.094 PIC 16F 84A 04/P
 11.19.095 PIC 16F627A I/P
 11.19.096 PIC 16F628A I/P
 11.19.097 PIC 16F630 I/P
 11.19.098 PIC 16F676 I/P
 11.19.099 PIC 16F688 I/P
 11.19.101 PIC 16F870 I/SP
 11.19.102 PIC 16F872 I/SP
 11.19.103 PIC 16F873A I/SP
 11.19.104 PIC 16F874 I/P
 11.19.105 PIC 16F876A I/SP
 11.19.106 PIC 16F877A I/P
 11.19.133 PL 1002 A
 11.99.029 PNX 85507
11.99.044 PS 2561
 11.19.110 PT 2314 SMD
 11.19.111 PT 2315 SMD
 11.19.142 Q 0765 R
11.99.048 R5F 2111 4FP SMD
 11.19.011 RC 4136 E
 11.19.114 RC 4558
 11.19.113 RC 4558 SMD
 11.19.141 RC 4560 = BA 4560
 8 PINOS
 11.99.030 REGUL 7805
 SMD - 3 TERM
 11.31.000 REGUL 7805 ISOLADO
 11.31.001 REGUL 7805 METAL
11.31.002 REGUL 7808 METAL
 11.31.003 REGUL 7809 METAL
 11.31.004 REGUL 7812 ISOLADO
 11.31.005 REGUL 7812 METAL
 11.31.006 REGUL 7815 ISOLADO
 11.31.007 REGUL 7815 METAL
 11.31.008 REGUL 7818 METAL
 11.31.009 REGUL 7824 METAL
11.99.015 REGUL 7885
11.31.017 REGUL 78L08
 11.31.016 REGUL 78L09
 11.31.010 REGUL 78R05 ISOLADO
 11.31.011 REGUL 78R08 ISOLADO
11.31.012 REGUL 78R09 ISOLADO
 11.31.013 REGUL 78R12 ISOLADO
 11.31.014 REGUL 78R33 ISOLADO
 11.19.116 RSN 35H2
 11.19.117 RSN 309W44C
 11.19.119 RSN 312H24
 11.19.120 RSN 314H41
 11.19.121 RSN 315H41
 11.19.122 RSN 315H42
 11.19.118 RSN 331W64B
 11.19.124 RSN 3502
11.99.046 RT 9199 SMD
11.99.050 SA 1117 H 1.8
 11.19.125 SAA 5542 PS/M4/1077
11.99.055 SC 73C1402 SMD
11.99.058 SDB 1060

11.19.126 SE 120
 11.19.127 SE 125 N
 11.19.128 SE 135
 11.19.129 SE 140 N
 11.19.130 SG 3524 N
 11.19.131 SG 3525 AN
 11.99.053 SN 74HC 19N
 11.19.134 SN 74HC04
11.99.017 SN 74HC14N
 11.19.136 SN 74HC573
 11.19.140 SN 74HC595 SMD
11.19.143 SSM 2165 SMD
11.99.031 ST 1S 10PHR REGUL
 11.19.139 STA 516 B - SMD
 11.19.132 STA 540 SA
 11.20.008 STK 392-010 ORIGINAL
 11.20.009 STK 392-020 ORIGINAL
 11.20.012 STK 401-120 ORIGINAL
 11.20.013 STK 402-030 ORIGINAL
 11.20.014 STK 402-030 S
 11.20.015 STK 402-040 ORIGINAL
 11.20.016 STK 402-050 ORIGINAL
 11.20.110 STK 402-070 IMPORTADO
 11.20.017 STK 402-070 ORIGINAL
 11.20.109 STK 402-070 S
 IMPORTADO
 11.20.018 STK 402-070 S ORIGINAL
 11.20.019 STK 402-090 ORIGINAL
 11.20.020 STK 402-090 S ORIGINAL
 11.20.021 STK 402-100 ORIGINAL
 11.20.022 STK 402-100 S ORIGINAL
 11.20.024 STK 402-120 ORIGINAL
 11.20.023 STK 402-120 S ORIGINAL
 11.20.028 STK 403-040 ORIGINAL
 11.20.029 STK 403-070 ORIGINAL
 11.20.030 STK 403-090 ORIGINAL
 11.20.031 STK 403-100 ORIGINAL
 11.20.032 STK 403-120 ORIGINAL
 11.20.033 STK 403-130 ORIGINAL
 11.20.035 STK 404-050 ORIGINAL
 11.20.036 STK 404-130 S ORIGINAL
 11.20.037 STK 405-070 ORIGINAL
 11.20.038 STK 405-090 ORIGINAL
 11.20.039 STK 405-100 ORIGINAL
 11.20.040 STK 405-120 ORIGINAL
 11.20.041 STK 407-090 ORIGINAL
 11.20.044 STK 411-210 ORIGINAL
 11.20.046 STK 411-220 ORIGINAL
 11.20.047 STK 411-230 E ORIGINAL
 11.20.048 STK 411-240 E ORIGINAL
 11.20.049 STK 411-550 E ORIGINAL
 11.20.106 STK 412-000
 11.20.050 STK 412-010 ORIGINAL
 11.20.051 STK 412-030 ORIGINAL
 11.20.052 STK 412-150 ORIGINAL
 11.20.053 STK 412-170 C SANYO
 11.20.054 STK 412-210 ORIGINAL
 11.20.055 STK 412-230 ORIGINAL
 11.20.056 STK 412-240 ORIGINAL
 11.20.057 STK 412-290 ORIGINAL
 11.20.060 STK 419-130 ORIGINAL
 11.20.000 STK 419-140 ORIGINAL
 11.20.061 STK 419-150 ORIGINAL
 11.20.062 STK 432-070 ORIGINAL
 11.20.063 STK 433-030 ORIGINAL
 11.20.064 STK 433-060 ORIGINAL
 11.20.065 STK 433-070 ORIGINAL
 11.20.066 STK 433-090 ORIGINAL



11.20.067 STK 433-100 ORIGINAL	11.21.042 STRM 6559	11.26.003 TCA 785	11.27.078 TDA 7263 PEQUENO - 11 PINOS
11.20.068 STK 433-120 = STK 433-130 SANYO	11.21.043 STRS 5707	11.27.001 TDA 1013 B	11.27.079 TDA 7264 - 8 PINOS
11.20.108 STK 433-130 = STK 433-120	11.21.044 STRS 5717	11.27.004 TDA 1083	11.27.080 TDA 7264 A - 11 PINOS
11.20.070 STK 442-110 ORIGINAL	11.21.045 STRS 5941	11.27.038 TDA 1175 P	11.27.123 TDA 7265
11.20.071 STK 442-130 ORIGINAL	11.21.046 STRS 6707	11.27.040 TDA 1515	11.27.031 TDA 7266 SA PEQUENO
11.20.072 STK 453-030 ORIGINAL	11.21.047 STRS 6709	11.27.007 TDA 1521 GDR	11.27.081 TDA 7267 - 8 PINOS
11.20.073 STK 453-030 S ORIGINAL	11.21.048 STRW 5453 A	11.27.041 TDA 1552	11.27.082 TDA 7267 A - 16 PINOS
11.20.074 STK 470-010 ORIGINAL	11.21.049 STRW 5453 C	11.27.042 TDA 1554	11.27.083 TDA 7269 A
11.20.075 STK 470-020 ORIGINAL	11.21.050 STRW 5456 C	11.27.043 TDA 1557 Q	11.27.084 TDA 7269 SA - PEQUENO
11.20.076 STK 470-040 ORIGINAL	11.21.051 STRW 5753 A	11.27.045 TDA 1675 A	11.27.005 TDA 7292
11.20.077 STK 470-050 ORIGINAL	11.21.052 STRW 6253	11.27.046 TDA 1904	11.27.085 TDA 7293
11.20.078 STK 470-090 ORIGINAL	11.21.053 STRW 6554 A	11.27.047 TDA 1905	11.27.032 TDA 7294
11.20.080 STK 490-040 S ORIGINAL	11.21.054 STRW 6556 A	11.27.048 TDA 2003	11.27.086 TDA 7295 PURO
11.20.081 STK 490-070 S ORIGINAL	11.21.055 STRW 6654	11.27.049 TDA 2004	11.27.087 TDA 7295 S
11.20.082 STK 490-110 ORIGINAL	11.21.056 STRW 6750 F	11.27.013 TDA 2005	11.27.088 TDA 7296 - 15 PINOS
11.20.083 STK 490-310 ORIGINAL	11.21.057 STRW 6753	11.27.014 TDA 2006	11.27.089 TDA 7296 S
11.20.085 STK 499-120 ORIGINAL	11.21.058 STRW 6754	11.27.015 TDA 2009	11.27.090 TDA 7297 PURO
11.20.086 STK 730-010 ORIGINAL	11.21.059 STRW 6756	11.27.051 TDA 2040	11.27.091 TDA 7297 SA
11.20.087 STK 730-020 ORIGINAL	11.21.060 STRW 6833	11.27.052 TDA 2050	11.27.092 TDA 7297 SA
11.20.088 STK 730-080 ORIGINAL	11.21.061 STRX 6556	11.27.053 TDA 2052 - 7 PINOS	11.27.093 TDA 7350 A
11.20.089 STK 730-090 ORIGINAL	11.21.070 STRX 6759 - ORIGINAL	11.27.054 TDA 2611 A	11.27.033 TDA 7374
11.20.090 STK 730-130 ORIGINAL	11.21.071 STRX 6765	11.27.055 TDA 2616	11.27.094 TDA 7375
11.20.107 STK 1050 - IMPORTADO	11.21.005 STRX 6769 ORIGINAL	11.27.021 TDA 2822 - 16 PINOS	11.27.094 TDA 7377
11.20.091 STK 4121 II ORIGINAL	11.21.063 STRZ 2154	11.27.020 TDA 2822 M - 8 PINOS	11.99.005 TDA 7384
11.20.092 STK 4122 II ORIGINAL	11.21.064 STRZ 2264	11.27.057 TDA 4601 PENTE	11.99.003 TDA 7385 H
11.20.093 STK 4131 II ORIGINAL	11.21.065 STV 8131	11.27.058 TDA 4605-3 INFINEON	11.99.002 TDA 7385 PURO
11.20.094 STK 4132 II ORIGINAL	11.21.073 STV 8179 F	11.27.059 TDA 4605-3 SIEMENS	11.27.097 TDA 7388
11.20.095 STK 4141 II ORIGINAL	11.21.066 STV 9302 A	11.27.060 TDA 4661	11.27.034 TDA 7394
11.20.096 STK 4142 II ORIGINAL	11.21.067 STV 9325	11.27.024 TDA 4662 GDE	11.27.098 TDA 7468 SMD
11.20.097 STK 4151 II ORIGINAL	11.21.068 STV 9326	11.27.025 TDA 4665 GDE	11.27.132 TDA 7492 P - SMD
11.20.098 STK 4152 II ORIGINAL	11.21.069 STV 9379 FA	11.27.061 TDA 4863 AJ	11.27.099 TDA 7497
11.20.099 STK 4181 V ORIGINAL	11.24.035 TA 2003	11.27.062 TDA 4864 AJ	11.27.100 TDA 7499
11.20.100 STK 4182 II ORIGINAL	11.24.036 TA 7222 AP	11.27.063 TDA 4866 4Y	11.27.101 TDA 7560
11.20.101 STK 4192 II ORIGINAL	11.24.037 TA 7274	11.27.064 TDA 4867 J	11.99.006 TDA 7561-H
11.20.102 STK 4211 II ORIGINAL	11.24.011 TA 7280 P	11.27.026 TDA 6101 Q	11.99.004 TDA 7562
11.20.103 STK 4221 II ORIGINAL	11.24.041 TA 7325 P	11.27.065 TDA 6103 Q	11.27.128 TDA 7851
11.20.104 STK 4362 II ORIGINAL	11.24.017 TA 7417 AP	11.27.066 TDA 6106 Q	11.27.131 TDA 8145
11.20.105 STK 73907 ORIGINAL	11.24.046 TA 8122 SMD	11.27.067 TDA 6107 JF	11.27.124 TDA 8170
11.21.000 STR 5412 ORIGINAL	11.24.047 TA 8125S	11.27.068 TDA 6108 JF	11.27.102 TDA 8172 = STV 8172
11.21.017 STR 44111 ORIGINAL	11.24.049 TA 8189	11.27.069 TDA 6109 JF	11.27.002 TDA 8177 F - ORIGINAL
11.21.003 STR 50103 A ORIGINAL	11.24.023 TA 8200	11.27.070 TDA 6111 Q	11.27.104 TDA 8179 S
11.21.006 STR 50213 ORIGINAL	11.24.025 TA 8207 K	11.27.028 TDA 7052 A	11.27.105 TDA 8350
11.21.007 STR 54041 ORIGINAL	11.24.026 TA 8210	11.27.071 TDA 7052 B	11.27.106 TDA 8351 4Y
11.21.008 STR 58041	11.24.067 TA 8211	11.27.073 TDA 7056 B	11.27.107 TDA 8356 5Y
11.21.018 STR 59041	11.24.030 TA 8221	11.27.074 TDA 7073 A	11.27.109 TDA 8358 J
11.21.009 STR 80145	11.24.051 TA 8227 P	11.27.075 TDA 7240 A	11.27.110 TDA 8359 J
11.21.004 STRA 6053 M - DIP 7 PINOS	11.24.032 TA 8229	11.27.076 TDA 7250	11.27.111 TDA 8380
11.21.020 STRA 6151	11.24.033 TA 8238	11.27.077 TDA 7263 L PENTE 10 PINOS	11.27.112 TDA 8560
11.21.021 STRA 6159	11.24.053 TA 8255 AH		11.27.113 TDA 8568
11.21.022 STRA 6251	11.24.054 TA 8264 AHQ		11.27.114 TDA 8571 J
11.21.023 STRA 6252	11.24.055 TA 8268 AH		11.27.115 TDA 8588 AJ
11.21.024 STRA 6259	11.99.008 TA 8276 H		11.27.116 TDA 8920 BJ - PENTE
11.21.025 STRF 5653 - ORIGINAL	11.24.056 TA 8403 K		11.27.117 TDA 8920 TH SMD
11.21.026 STRF 5654	11.24.057 TA 8409 S		11.99.032 TDA 8932 BTW SMD
11.21.028 STRF 6453	11.24.058 TA 8427 K		11.27.119 TDA 8947 J
11.21.029 STRF 6456	11.24.060 TA 8445 K		11.27.006 TDA 8950 J
11.21.030 STRF 6707 A	11.24.061 TA 8628		11.27.120 TDA 9302 H
11.21.032 STRG 5643 D	11.24.062 TA 8680 BN		11.27.130 TDA 9309
11.21.033 STRG 5653	11.24.063 TA 8718 N		11.27.121 TDA 9370 PS/N3/A
11.21.034 STRG 6153	11.24.065 TA 8867 BN		11.27.126 TDA 9540 H/N3/2/1784
11.21.036 STRG 6551	11.24.066 TA 8880 CN		11.27.127 TDA 9580 - SMD
11.21.037 STRG 6651	11.25.014 TAS 5152		11.99.047 TDA 9850
11.21.038 STRG 6653	11.25.010 TB 1229 BN		11.99.033 TDA 9886T
11.21.039 STRG 8644 D	11.25.011 TB 1231 AN		11.99.007 TDA15190/N3/5420 (N 70035AB)
11.21.040 STRG 8656	11.25.013 TB 2903 HQ		
	11.26.000 TC 9153 AP		

- 11.27.122 TDA16846 14PINOS
- 11.28.004 TEA 1506 T SMD
- 11.28.005 TEA 1507 P
- 11.28.006 TEA 1533 AT SMD
- 11.28.017 TEA 1620
- 11.28.007 TEA 2025
- 11.28.008 TEA 2260
- 11.28.009 TEA 2261
- 11.28.001 TEA 2262
- 11.28.003 TEA 3718 S
- 11.28.011 TFA 9842 AJ
- 11.28.010 THX 203
- 11.29.027 TL 071
- 11.29.028 TL 072
- 11.29.022 TL 072 CDT - SMD
- 11.29.029 TL 074
- 11.29.030 TL 081
- 11.29.031 TL 082
- 11.99.018 TL 431 (TIPO BC)**

- 11.29.032 TL 494
- 11.29.033 TLP 521
- 11.29.034 TLP 621 - 4 PINOS
- 11.99.034 TMD5 261 PAG SMD**
- 11.29.068 TNY 173
- 11.29.067 TNY 176
- 11.29.065 TNY 177 PN**
- 11.29.035 TNY 254 PN
- 11.29.071 TNY 266 PN
- 11.29.037 TNY 267 PN
- 11.29.038 TNY 268 PN
- 11.29.039 TNY 274 PN
- 11.29.040 TNY 275 PN
- 11.29.041 TNY 277 PN
- 11.29.042 TOP 222 G
- 11.29.043 TOP 222 P
- 11.29.044 TOP 222 Y 3 PINOS
- 11.29.045 TOP 223 P 8 PINOS
- 11.29.046 TOP 223 Y 3 PINOS

- 11.29.047 TOP 224 Y 3 PINOS
- 11.29.048 TOP 225 Y 3 PINOS
- 11.29.062 TOP 244 P
- 11.29.049 TOP 245 PN
- 11.29.050 TOP 245 Y
- 11.29.069 TOP 246 YN
- 11.29.063 TOP 247 P
- 11.29.064 TOP 247 Y
- 11.29.051 TOP 249 Y
- 11.29.070 TOP 255 EN - 6 PINOS
- 11.99.035 TPA 3124 SMD**
- 11.28.014 TT 2170
- 11.28.015 TT 2206 GDE
- 11.28.016 TT 2206 PEQ
- 11.28.018 UA 184
- 11.29.052 UC 3842 AN
- 11.29.053 UC 3842 B , P
- 11.29.054 UC 3842 BN
- 11.29.055 UC 3843

- 11.29.056 UC 3844 BN
- 11.29.057 UC 3845
- 11.29.058 ULN 2003 AN
- 11.29.066 ULN 2003 SMD
- 11.29.059 ULN 2004 A
- 11.29.060 ULN 2803 A
- 11.29.025 UPC 1316 C
- 11.29.026 UPC 1379
- 11.32.000 VIPER 12 A
- 11.32.001 VIPER 17L - 7 PINOS
- 11.99.036 WT 6703F SMD
- 11.99.042 X 24C02 WP SMD**
- 11.29.061 X 24C08 SMD
- 11.99.010 X 24C16 WBN6P MEMORIA**
- 11.99.011 X 24C32 WBNC P MEMORIA**
- 11.29.072 X 24LC02 B
- 11.99.037 XC 9572XL 44 PINOS SMD**
- 11.99.057 YG 902C2**

Todos os nomes, logotipos de empresas e produtos citados neste catálogo são marcas registradas de suas respectivas corporações. A citação dos mesmos tem a única intenção de auxiliar nossos clientes na identificação de nossos produtos que são compatíveis com os originais.



- 35.01.002 TR 2N 2219 A METAL
- 35.01.013 TR 2N 2222 A PLASTICO
- 35.01.003 TR 2N 2222 METAL
- 35.01.018 TR 2N 2369
- 35.01.004 TR 2N 2646 METAL
- 35.01.043 TR 2N 3055 IMPORTADO**
- 35.01.005 TR 2N 3055 ORIGINAL
- 35.01.006 TR 2N 3772
- 35.01.007 TR 2N 3773
- 35.01.023 TR 2N 3866
- 35.01.008 TR 2N 6027
- 35.01.010 TR 2N 6510
- 35.01.011 TR 2N 6512
- 35.01.012 TR 2N 6513
- 35.02.006 TR 2SA 564
- 35.02.007 TR 2SA 614
- 35.02.008 TR 2SA 733
- 35.02.009 TR 2SA 899
- 35.02.010 TR 2SA 933
- 35.02.011 TR 2SA 940
- 35.02.012 TR 2SA 968
- 35.02.014 TR 2SA 1006 METAL
- 35.02.015 TR 2SA 1013
- 35.02.016 TR 2SA 1046
- 35.02.017 TR 2SA 1048
- 35.02.018 TR 2SA 1271
- 35.02.020 TR 2SA 1320
- 35.02.004 TR 2SA 1386
- 35.02.024 TR 2SA 1930
- 35.02.022 TR 2SA 1941
- 35.02.023 TR 2SA 1943 + 2SC 5200 (PAR)**

- 35.02.121 TR 2SA 1964
- 35.03.029 TR 2SB 631
- 35.03.002 TR 2SB 688 ORIGINAL
- 35.03.004 TR 2SB 772 (FORMATO BC)
- 35.03.006 TR 2SB 778 ORIGINAL
- 35.03.007 TR 2SB 817
- 35.03.009 TR 2SB 1041
- 35.03.012 TR 2SB 1273
- 35.03.013 TR 2SB 1340
- 35.03.015 TR 2SB 1342
- 35.03.016 TR 2SB 1344
- 35.03.017 TR 2SB 1370
- 35.03.018 TR 2SB 1587
- 35.03.019 TR 2SB 1588
- 35.03.020 TR 2SB 1624
- 35.04.023 TR 2SC 643
- 35.04.003 TR 2SC 834
- 35.04.002 TR 2SC 945
- 35.04.024 TR 2SC 1213
- 35.04.025 TR 2SC 1448
- 35.04.004 TR 2SC 1507
- 35.04.026 TR 2SC 1740
- 35.04.027 TR 2SC 1815
- 35.04.028 TR 2SC 1959
- 35.04.007 TR 2SC 2073
- 35.04.029 TR 2SC 2235
- 35.04.030 TR 2SC 2236
- 35.04.031 TR 2SC 2240
- 35.04.032 TR 2SC 2335
- 35.04.034 TR 2SC 2336 METAL
- 35.04.035 TR 2SC 2690
- 35.04.036 TR 2SC 3181
- 35.04.038 TR 2SC 3182
- 35.04.011 TR 2SC 3198
- 35.04.039 TR 2SC 3200

- 35.04.040 TR 2SC 3207
- 35.04.041 TR 2SC 3209
- 35.04.250 TR 2SC 3263
- 35.04.014 TR 2SC 3678
- 35.04.042 TR 2SC 3795
- 35.04.043 TR 2SC 3807
- 35.04.044 TR 2SC 3831
- 35.04.045 TR 2SC 3852
- 35.04.047 TR 2SC 3979
- 35.04.048 TR 2SC 3997
- 35.04.049 TR 2SC 4056
- 35.04.051 TR 2SC 4236
- 35.04.052 TR 2SC 4237
- 35.04.053 TR 2SC 4429 ORIGINAL
- 35.04.054 TR 2SC 4430
- 35.04.055 TR 2SC 4793
- 35.04.017 TR 2SC 4833 ORIGINAL
- 35.04.018 TR 2SC 4834 M
- 35.04.056 TR 2SC 4834 N ORIGINAL
- 35.04.057 TR 2SC 4834 P
- 35.04.019 TR 2SC 4927 ORIGINAL
- 35.04.060 TR 2SC 5129
- 35.04.061 TR 2SC 5148
- 35.04.062 TR 2SC 5149
- 35.04.063 TR 2SC 5171
- 35.04.064 TR 2SC 5198 ORIGINAL
- 35.04.229 TR 2SC 5248
- 35.04.065 TR 2SC 5280
- 35.04.066 TR 2SC 5296
- 35.04.020 TR 2SC 5297
- 35.04.076 TR 2SC 5343
- 35.04.067 TR 2SC 5386 ORIGINAL
- 35.04.068 TR 2SC 5411 - ORIGINAL
- 35.04.069 TR 2SC 5902
- 35.04.070 TR 2SC 5909 ORIGINAL
- 35.04.071 TR 2SC 5929 ORIGINAL
- 35.04.072 TR 2SC 6073
- 35.04.073 TR 2SC 6090 ORIGINAL
- 35.04.022 TR 2SC 6093
- 35.05.030 TR 2SD 313
- 35.05.056 TR 2SD 401
- 35.05.031 TR 2SD 718 ORIGINAL
- 35.05.032 TR 2SD 882
- 35.05.033 TR 2SD 998 ISOLADO
- 35.05.034 TR 2SD 1047
- 35.05.035 TR 2SD 1071
- 35.05.036 TR 2SD 1308

- 35.05.037 TR 2SD 1397 ORIGINAL
- 35.05.015 TR 2SD 1554 ORIGINAL
- 35.05.038 TR 2SD 1555
- 35.05.016 TR 2SD 1577
- 35.05.039 TR 2SD 1650 ORIGINAL
- 35.05.017 TR 2SD 1651
- 35.05.040 TR 2SD 1710
- 35.05.020 TR 2SD 1877
- 35.05.021 TR 2SD 1878
- 35.05.041 TR 2SD 1879 ORIGINAL
- 35.05.042 TR 2SD 1881
- 35.05.044 TR 2SD 1889
- 35.05.046 TR 2SD 1933
- 35.05.047 TR 2SD 2059
- 35.05.058 TR 2SD 2061**
- 35.05.048 TR 2SD 2253
- 35.05.049 TR 2SD 2293
- 35.05.026 TR 2SD 2438
- 35.05.050 TR 2SD 2439
- 35.05.051 TR 2SD 2493 ORIGINAL
- 35.05.052 TR 2SD 2499
- 35.05.171 TR 2SD 2539
- 35.05.053 TR 2SD 2580 ORIGINAL
- 35.05.018 TR 2SD 2689 - C/ DIODO ORIGINAL
- 35.05.054 TR 2SD 2693 ORIGINAL
- 35.05.028 TR 2SD 5071
- 35.05.029 TR 2SD 5072
- 35.05.055 TR 2SD 5702
- 35.05.057 TR 2SD 838
- 35.06.008 TR 2SJ 111
- 35.17.033 TR 2SJ 4310
- 35.06.001 TR 2SJ 6806 D
- 35.06.002 TR 2SJ 6808 D
- 35.06.003 TR 2SJ 6810
- 35.06.004 TR 2SJ 6812
- 35.06.005 TR 2SJ 6820
- 35.06.006 TR 2SJ 6916
- 35.06.007 TR 2SJ 6920 A
- 35.07.004 TR 2SK 557
- 35.07.005 TR 2SK 724
- 35.07.008 TR 2SK 1118
- 35.07.009 TR 2SK 1357
- 35.07.010 TR 2SK 1358
- 35.07.012 TR 2SK 1460 ORIGINAL
- 35.07.002 TR 2SK 1507
- 35.07.013 TR 2SK 1611

Transistores



35.07.015 TR 2SK 2003	35.11.007 TR BT 139-600 E	35.16.026 TR IRF 3710	35.18.022 TR P 10N80 C - ISOLADO
35.07.017 TR 2SK 2129	35.11.008 TR BT 139-800	35.16.028 TR IRF 9530	35.18.024 TR P 11N60 - ISOLADO
35.07.018 TR 2SK 2137	35.11.009 TR BT 151-500 METAL	35.16.029 TR IRF 9540	35.18.023 TR P 11N60 - METAL
35.07.019 TR 2SK 2139	35.11.011 TR BTA 06-600	35.16.030 TR IRF 9610	35.18.041 TR P 11N60 C3 - ISOLADO
35.07.020 TR 2SK 2141	35.11.012 TR BTA 08-600	35.16.031 TR IRF 9630	35.18.025 TR P 12N50 C3
35.07.024 TR 2SK 2545	35.11.014 TR BTA 12-600	35.16.033 TR IRF 9640	35.18.026 TR P 12N60 - ISOLADO
35.07.025 TR 2SK 2646	35.11.015 TR BTA 16-600 METAL	35.99.001 TR IRF 9640 S - SMD	35.18.027 TR P 12N80 - ISOLADO
35.07.027 TR 2SK 2696	35.11.016 TR BTA 26-600	35.16.034 TR IRFBA 3207	35.18.046 TR P 12N80 FI - ISOLADO
35.07.028 TR 2SK 2699	35.11.017 TR BTA 41-600	35.16.035 TR IRFBA 1404 P	35.18.014 TR P 13NM60N - ISOLADO
35.07.029 TR 2SK 2740 ORIGINAL	35.11.018 TR BTB 12-600 B	35.16.036 TR IRFI 520 - ISOLADO	35.18.028 TR P 14NF12 - METAL
35.07.031 TR 2SK 2843 ORIGINAL	35.12.001 TR BU 406	35.16.037 TR IRFP 054	35.18.044 TR P 15P12 - METAL
35.07.032 TR 2SK 2937	35.12.002 TR BU 407 METAL	35.16.038 TR IRFP 064	35.18.030 TR P 16N60 C - ISOLADO
35.07.033 TR 2SK 2996	35.12.003 TR BU 808 DFX - 1 LINHA	35.16.040 TR IRFP 240	35.18.031 TR P 18NQ11 T- ISOLADO
35.07.021 TR 2SK 3053 IMPORTADO	35.12.008 TR BU 1508 DX - ORIGINAL	35.16.041 TR IRFP 250	35.18.048 TR P 19N20 - METÁLICO
35.07.003 TR 2SK 3053 ORIGINAL	35.12.009 TR BU 2506 DX - ORIGINAL	35.16.042 TR IRFP 260	35.18.032 TR P 20N60 - METAL
35.99.002 TR 2SK 3561 ORIGINAL	35.12.032 TR BU 2508 DX - ORIGINAL	35.16.043 TR IRFP 264	35.18.033 TR P 33N10 - ISOLADO
35.07.034 TR 2SK 3565	35.12.034 TR BU 2520 AF - ORIGINAL	35.16.044 TR IRFP 350	35.18.034 TR P 50N06 - ISOLADO
35.07.035 TR 2SK 3799	35.12.012 TR BU 2520 DX - ORIGINAL	35.16.045 TR IRFP 360	35.18.035 TR P 55N06 - ISOLADO
35.08.007 TR BC 327 PHILIPS (PRATA)	35.12.014 TR BU 2527 DX - ORIGINAL	35.16.046 TR IRFP 450	35.18.036 TR P 55NF06 - METAL
35.08.008 TR BC 327-25	35.12.036 TR BU 4508 DF - ORIGINAL	35.16.047 TR IRFP 460	35.18.043 TR P 70N06 - METAL IMP.
35.08.009 TR BC 328	35.12.015 TR BU 4508 DX - ORIGINAL	35.16.048 TR IRFP 9240	35.18.037 TR P 80NF55 - METAL
35.08.006 TR BC 337	35.12.016 TR BUH 315 D ORIGINAL	35.16.005 TR IRFS 23N15D	35.19.020 TR ST 2001
35.08.026 TR BC 337-25	35.12.017 TR BUH 515 D ORIGINAL	35.16.049 TR IRFZ 24	35.19.021 TR ST 2310 - IMPORTADO
35.08.011 TR BC 338	35.12.019 TR BUH 517	35.16.050 TR IRFZ 34	35.20.050 TR T 41060
35.08.028 TR BC 368	35.12.021 TR BUK 444-500 ISOLADO	35.16.051 TR IRFZ 40	SMD - T 410-600
35.08.012 TR BC 369	35.12.035 TR BUL 312 FP - ISOLADO	35.16.052 TR IRFZ 44	35.20.001 TR TIC 106 D
35.08.030 TR BC 517	35.12.022 TR BUT 11 A	35.16.053 TR IRFZ 46	35.20.002 TR TIC 106 M
35.08.015 TR BC 546	35.12.024 TR BUT 11 AF	35.16.054 TR IRFZ 48	35.20.003 TR TIC 116 M
35.08.016 TR BC 547	35.12.027 TR BUT 11 APX ORIGINAL	35.16.056 TR IRS 2092 S - SMD	35.20.004 TR TIC 126 D
35.08.054 TR BC 547 PHILIPS	35.12.028 TR BUT 11 AX	35.16.055 TR J 3305 -1 -	35.20.006 TR TIC 226 D
PRATA (PRÉ CORTADO)	35.12.029 TR BUT 12 AF	FORMATO TIP	35.20.007 TR TIC 246 D
35.08.031 TR BC 548	35.12.030 TR BUT 12 AX	35.99.003 TR K 15A60D	35.20.008 TR TIC 246 M
35.08.017 TR BC 549	35.12.031 TR BUW 84	35.17.001 TR MAC 12	35.20.027 TR TIP 29 C
35.08.032 TR BC 550	35.14.003 TR DTA 114	35.17.002 TR MAC 97	35.20.009 TR TIP 31 C - METAL
35.08.033 TR BC 556 B	35.14.004 TR DTA 114 SMD	35.17.003 TR MCR 25	35.20.010 TR TIP 32 C - METAL
35.08.019 TR BC 557	35.14.005 TR DTA 123	37.17.036 TR MDF 7N50	35.20.011 TR TIP 35 C
35.08.020 TR BC 558	35.14.006 TR DTA 123 SMD	35.17.030 TR MJ 802 ORIGINAL	35.20.012 TR TIP 36 C
35.08.021 TR BC 559	35.14.007 TR DTA 124 SMD	35.17.006 TR MJ 15003 IMPORTADO	35.20.013 TR TIP 41 C ISOLADO
35.08.022 TR BC 560	35.14.008 TR DTA 143	35.17.005 TR MJ 15003 ORIGINAL	35.20.014 TR TIP 41 C METAL
35.08.023 TR BC 635	35.14.009 TR DTA 143 SMD	35.17.007 TR MJ 15004 ORIGINAL	35.20.015 TR TIP 42 C ISOLADO
35.08.024 TR BC 636	35.14.010 TR DTA 144	35.17.012 TR MJE 2955	35.20.016 TR TIP 42 C METAL
38.08.024 TR BC 636	35.14.012 TR DTB 143	35.17.013 TR MJE 3055	35.20.019 TR TIP 50
35.08.034 TR BC 637	35.14.014 TR DTC 114	35.17.028 TR MJE 13005	35.20.021 TR TIP 105
35.08.035 TR BC 638	35.14.015 TR DTC 114ET SMD	35.17.015 TR MJE 13007	35.20.022 TR TIP 106
35.08.036 TR BC 639	35.14.018 TR DTC 123 YS	35.17.031 TR MJE 13009	35.20.023 TR TIP 107 ORIGINAL
35.08.025 TR BC 640	35.14.019 TR DTC 124	35.17.018 TR MJE 15032	35.20.024 TR TIP 110
35.08.037 TR BC 817 SMD	35.14.020 TR DTC 143	35.17.019 TR MJE 15033	35.20.025 TR TIP 115
35.08.038 TR BC 847 SMD SOT-23	35.14.021 TR DTC 143 SMD	35.17.020 TR MPSA 42	35.20.026 TR TIP 122
35.08.039 TR BC 848 SMD	35.14.022 TR DTC 144 SMD	35.17.021 TR MPSA 92	35.20.029 TR TIP 127
35.08.041 TR BC 857 SMD	35.15.002 TR FN 1016	35.17.035 TR MPSA 94	35.20.030 TR TIP 140
35.08.042 TR BC 858 SMD	35.15.004 TR FP 1016	35.17.034 TR MUR 1620	35.20.031 TR TIP 141
35.09.002 TR BD 135	35.15.003 TR FQN 1N50C	35.18.001 TR P 3N60 - ISOLADO	35.20.032 TR TIP 142 GDE (TO 247)
35.09.003 TR BD 136	35.16.002 TR IRF 510	35.18.002 TR P 4N60 - ISOLADO	35.20.033 TR TIP 142 PEQ
35.09.005 TR BD 137-16	35.16.003 TR IRF 520	35.18.003 TR P 5N80 - ISOLADO	35.20.034 TR TIP 145
35.09.006 TR BD 138	35.16.004 TR IRF 530	35.18.004 TR P 5N80 - METAL	35.20.035 TR TIP 147 GDE - TO 247
35.09.007 TR BD 139	35.16.006 TR IRF 540 N	35.18.006 TR P 6N60 - ISOLADO	35.20.036 TR TIP 147 PEQ
35.09.008 TR BD 140	35.16.008 TR IRF 630	35.18.005 TR P 6N60 - METAL	35.20.037 TR TIP 2955 METAL
35.09.034 TR BD 241	35.16.009 TR IRF 640 N	35.18.007 TR P 6N80 - METAL	35.20.039 TR TIP 3055 METAL
35.09.032 TR BD 335	35.16.012 TR IRF 730	35.18.008 TR P 6N80 C - ISOLADO	35.20.040 TR TT 2076
35.09.033 TR BD 336	35.16.013 TR IRF 740	35.18.009 TR P 6NK90 - ISOLADO	35.20.041 TR TT 2170
35.09.019 TR BD 677	35.16.014 TR IRF 820	35.18.010 TR P 7N60 C - ISOLADO	35.20.042 TR TT 2206 GDE
35.09.020 TR BD 678	35.16.015 TR IRF 822 FI - ISOLADO	35.18.011 TR P 7NK80 - ISOLADO	35.20.043 TR TT 2206 PEQ
35.10.005 TR BF 422	35.16.016 TR IRF 822 - METAL	35.18.012 TR P 8N60 - METAL	35.20.049 TR TT 2222
35.10.006 TR BF 423	35.16.017 TR IRF 830	35.18.038 TR P 8N60 C - ISOLADO	
35.10.009 TR BF 458	35.16.018 TR IRF 840	35.18.039 TR P 8N80 C - ISOLADO	
35.10.010 TR BF 459	35.16.019 TR IRF 1010	35.18.013 TR P 8NF55 - METAL	
35.10.013 TR BF 494	35.16.020 TR IRF 1104	35.18.040 TR P 9N60 - ISOLADO	
35.10.014 TR BF 495	35.16.021 TR IRF 1404	35.18.015 TR P 9N60 - METAL	
35.11.003 TR BT 134-600	35.16.022 TR IRF 1405	35.18.017 TR P 9N70 - ISOLADO	
35.11.004 TR BT 136-600 E	35.16.023 TR IRF 2807	35.18.018 TR P 9N90 - ISOLADO	
35.11.005 TR BT 137-600	35.16.024 TR IRF 3205 PBF	35.18.016 TR P 9NK65 - ISOLADO	
35.11.006 TR BT 138-600	35.16.025 TR IRF 3415	35.18.021 TR P 10N60 - ISOLADO	

TND

ELETRÔNICA



(11) 3313 5198 | 2950 3569



(11) 99408 1811



www.tndeletronica.com.br



www.facebook.com/tndeletronica



18.14.000
TELA DISPLAY LED 24 POL.
V236BJ1-LE1 VER. C3



24.12.037
JOYSTICK COM MEMÓRIA , PHILCO
2RCA AM / VERM.



24.13.000
ÓCULOS 3D POSITIVO



OLHO DE BOI SINALIZADOR
110V **FIO PRETO**
15.10.000 - VERMELHO
15.10.001 - VERDE
15.10.002 - AMARELO



OLHO DE BOI SINALIZADOR
220V **FIO VERMELHO**
15.10.003 - VERDE
15.10.004 - VERMELHO
15.10.005 - AMARELO



07.02.070
CAP. ELETROLÍTICO
105° 470UF X 250V



GARRA JACARÉ
BATERIA 150A
20.00.027 - PRETA
20.00.028 - VERMELHA



10.26.082
CHAVE TÁCTIL 6,0X
6,0 KNOB 4,3MM 5T



12.15.002
CONECTOR BORNE
KRE KF-3000 AZUL
NORMAL 180° 2
TERMINAIS



12.15.000
CONECTOR BORNE
KRE KF-301
AZUL MINI 180° 2
TERMINAIS



12.15.001
CONECTOR BORNE
KRE KF-301
AZUL MINI 180° 3
TERMINAIS



12.15.003
CONECTOR BORNER
KRE KF-3000 AZUL
NORMAL 180° 3
TERMINAIS

OFERTA



12.15.008
CONECTOR
BORNE 2EDG
VERDE 90° 2
TERMINAIS



12.15.009
CONECTOR
BORNE 2EDG
VERDE 90° 3
TERMINAIS



12.15.011
CONECTOR BORNE 2EDG
VERDE 90° 7 TERMINAIS



12.15.006
CONECTOR
BORNE KF-103
VERDE 45° KRE
2 TERMINAIS



12.15.004
CONECTOR
BORNE KF-128
VERDE 180° KRE
2 TERMINAIS



12.15.005
CONECTOR
BORNE KF-128
VERDE 180° KRE
3 TERMINAIS



12.15.007
CONECTOR
BORNE KF-103
VERDE 45° KRE
3 TERMINAIS



www.tndeletronica.com.br

FECHAMENTO AUTORIZADO
PODE SER ABERTO PELA ECT

Uso exclusivo do Correio :		Data da reintegração
<input type="checkbox"/> Ausente	<input type="checkbox"/> Endereço insuficiente	__/__/__
<input type="checkbox"/> Falecido	<input type="checkbox"/> Não existe o nº indicado	
<input type="checkbox"/> Recusado	<input type="checkbox"/> Desconhecido	
<input type="checkbox"/> Mudou-se	<input type="checkbox"/> Outros (especificar) _____	Rubrica do carteiro